



CATÁLOGO 2026

MOTΛKΟ



**EVERYTHING
IS CONNECTED**

WWW.MOTAKO.PT



PERFIL MOTTA

A Motako destaca-se por apresentar aos seus clientes uma oferta personalizada de produtos e serviços. Não só na produção de luminárias, sendo possível escolher o perfil e a fita de led, mas também na produção de neons customizados, graças a máquinas especializadas para o efeito oferecendo serviços únicos e exclusivos.

Contamos com uma equipa com um vasto conhecimento técnico e experiência nesta área, que está sempre pronta a ajudar os seus parceiros.

A iluminação é a nossa paixão e o nosso objetivo é sermos líderes no mercado de iluminação e destacarmo-nos com os nossos produtos inovadores e de alta qualidade.

O nossos valores / *Nuestros valores:*

QUALIDADE • PAIXÃO • RESPONSABILIDADE • PERSONALIZAÇÃO • INOVAÇÃO • TRABALHO EM EQUIPA • PROFISSIONALISMO



Motako se destaca por presentar a sus clientes una oferta personalizada de productos y servicios. No sólo en la producción de luminarias, donde es posible elegir el perfil y la tira LED, sino también en la producción de neones personalizados, gracias a máquinas

especializadas para este fin, ofreciendo servicios únicos y exclusivos. Contamos con un equipo con amplios conocimientos técnicos y experiencia en este ámbito, siempre dispuesto a ayudar a sus socios.

La iluminación es nuestra pasión y nuestro objetivo es ser líderes en el mercado de la iluminación y destacarnos con nuestros productos innovadores y de alta calidad.

Para ofrecer los mejores productos contamos con as marcas que representamos:

Para ofrecer los mejores productos, confiamos en las marcas que representamos:



2018

REPRESENTANTES
OFICIAIS DAS MARCAS
MEANWELL E LUMINES



2020

REBRANDING
TAKO > MOTAKO



MOTAKO®
LED LIGHTING SOLUTIONS

REPRESENTANTES
OFICIAIS DA MARCA TCI



2022

ACRÉSCIMO DA EQUIPA
REPRESENTANTES

EXCLUSIVOS
DA MARCA NEXTA



2017

NASCIMENTO DA
EMPRESA E CRIAÇÃO
DA MARCA TAKO

2019

ALTERAÇÃO DE
INSTALAÇÕES PARA
UM ESPAÇO MAIOR E
PROXIMIDADE
À CAPITAL

2021

INTERNACIONALIZAÇÃO
ESPANHA

CRIAÇÃO DO NOSSO
SHOWROOM

A EVOLUÇÃO DA EMPRESA

A empresa surgiu em 2017 com o intuito de prestar um melhor atendimento e dedicação ao cliente, servindo-o com produtos inovadores e de maior qualidade, na área da iluminação.

Iniciou-se com cerca de 200 referências, onde estão incluídas: fitas de led, fontes de alimentação, controladores, perfis, projetores e iluminação aquática.

Hoje em dia, com mais de 3500 referências de produtos, começamos a apostar não só em iluminação, como em todo um mundo de inteligência para habitação.

2023

SERVIÇO INOVADOR EM PORTUGAL, DE CUSTOMIZAÇÃO DE FITA DE LED NEON À MEDIDA

2024

FORTE APOSTA NA GAMA DE LED NEON

NOVO CONFIGURADOR ONLINE DE LUMINÁRIAS

criação de nova marca

AUMENTO DA EQUIPA
14 PESSOAS 

2025

LANÇAMENTO DO NOVO SITE

criação do serviço HIL

CRESCIMENTO DA EQUIPA
20 PESSOAS 

NOVO PARCEIRO DE PRODUTOS DE MOBILIÁRIO - 2RLIGHT

 **2R LIGHT**

MUDANÇA PARA NOVAS INSTALAÇÕES

LA EVOLUCIÓN DE LA EMPRESA

La empresa fue creada en 2017 con el objetivo de brindar un mejor servicio y dedicación al cliente, sirviéndolo con productos innovadores y de mayor calidad en el área de iluminación.

Comenzó con alrededor de 200 referencias, que incluyen: tiras LED, fuentes de alimentación, controladores, perfiles, proyectores e iluminación acuática.

Hoy, con más de 3500 referencias de producto, empezamos a invertir no solo en iluminación, sino en todo un mundo de inteligencia para la vivienda.



_ PERFIL ANDORRA

CONSULTE O NOSSO **WEBSITE!**

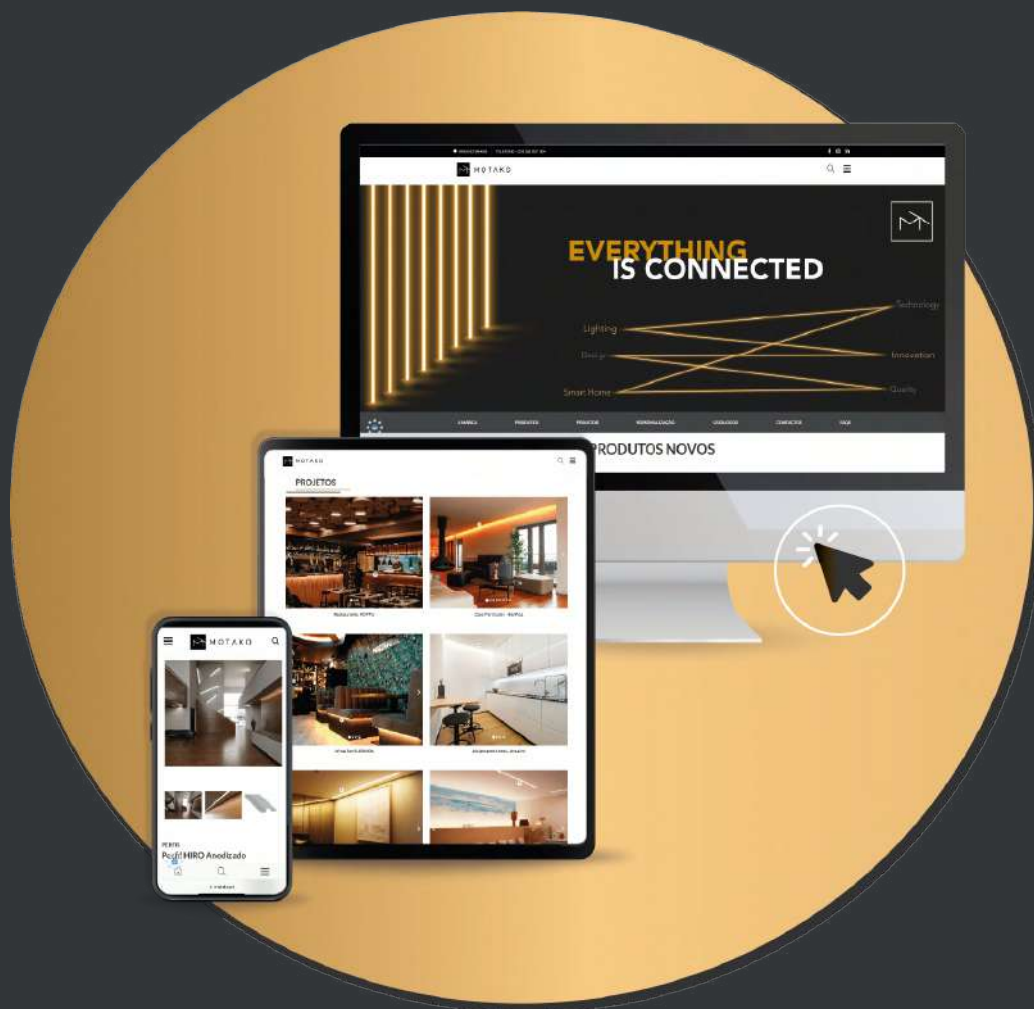

O QUE PODE ENCONTRAR:

- ✓ Novos Produtos;
- ✓ Apresentação de Projetos;
- ✓ Serviços de Personalização;
- ✓ Entre outras novidades.

www.motako.pt

LUMINES
LIGHTING

EAGLE RISE

CASAMBI

zigbee

TCL LED
professional led applications

MW
MEAN WELL

OLFER
The Power Supply Company

OPTIMUS
POWER

NEXTA

2R LIGHT

TECNOLOGIAS LED

NOVA TECNOLOGIA

SOB System on Board

A SOB é uma tecnologia LED avançada, na qual os chips led são montados como o SMD, mas adiciona uma camada de adesivo, obtendo uma faixa de luz contínua, conferindo um efeito de luz uniforme.

A tecnologia SOB combina a uniformidade do COB com a flexibilidade da faixa de luz e resolve a incapacidade atual do COB de aumentar a potência e o lúmen.

SOB es una tecnología LED avanzada en la que los chips LED se montan como SMD, pero se añade una capa adhesiva, lo que permite obtener una banda de luz continua y conferir un efecto de luz uniforme.

La tecnología SOB combina la uniformidad del COB con la flexibilidad de la banda de luz y resuelve la incapacidad actual del COB para aumentar la potencia y los lúmenes.

CSP

O CSP é um tipo de led que utiliza uma tecnologia inovadora, em que o chip é aplicado diretamente na placa PCB e o seu revestimento é feito diretamente na superfície do chip.

CSP es un tipo de LED que utiliza una tecnología innovadora, en la que el chip se aplica directamente a la placa PCB y su recubrimiento se aplica directamente a la superficie del chip.

INOVAÇÃO



NOVA TECNOLOGIA

FITAS R2R

A Motako está sempre a inovar, com o propósito de melhorar a experiência e a qualidade dos produtos. Apresentamos agora a novidade **R2R**: as nossas novas fitas contêm um PCB contínuo, sem uniões de soldadura.

Motako siempre está innovando con el objetivo de mejorar la experiencia y la calidad de los productos. Ahora presentamos la novedad R2R: nuestras nuevas cintas contienen una PCB continua, sin uniones soldadas.





Fita Led 2835-120
Fita Led ELARA
Import. Nr.: 400/2024
Código: 132141.0960

Cold White (6000K)



5601321410960

Φuse: 460lm/0.5m in a sphere (360°)

Não deve ser eliminado como lixo municipal indiferenciado.

Nota: Esta fita não deverá ser ligada em troços superiores a 5mt. Esta embalagem deve ser guardada para confirmação de cor.



R2R - Rolo a Rolo

GRANDE VANTAGEM:

- _ Menor possibilidade de quebra na soldadura;
- _ Menor aquecimento durante a utilização;
- _ Diminuição de manuseamento da fita no processo de fabrico, garantindo uma maior garantia da fita;
- _ Aumento da vida útil dos Leds devido a um menor tempo exposto a grande temperatura no processo de solda.

GRANDE VANTAGEM:

- _ Menor posibilidad de rotura en la soldadura;
- _ Menor calentamiento durante el uso;
- _ Menor manipulación de la cinta durante el proceso de fabricación, lo que garantiza una mayor garantía de la cinta;
- _ Aumento de la vida útil de los LED debido a un menor tiempo de exposición a altas temperaturas durante el proceso de soldadura.

UM NOVO SERVIÇO MOTAKO

UN NUEVO SERVICIO

HIGH IMPACT LIGHTING

NEONS E LUMINÁRIAS
DE ALTA PROTEÇÃO
E ALTO IMPACTO

NEONES Y LUMINARIAS
DE ALTA PROTECCIÓN Y ALTO IMPACTO



O SEU PROJETO DE SONHO, O NOSSO SERVIÇO

EL PROYECTO DE SUS SUEÑOS, NUESTRO SERVICIO

PERSONALIZE AS CARACTERÍSTICAS DA SUA LUMINÁRIA

PERSONALICE LAS CARACTERÍSTICAS DE SU LUMINARIA

LUMINÁRIA HIL



MODELOS DISPONÍVEIS MODELOS DISPONIBLES

Possibilidade de encher
uma grande variedade
dos nossos perfis.*

Posibilidad de rellenar una
gran variedad de nuestros
perfiles.*

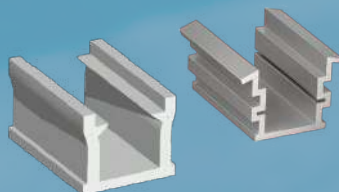

TEMPERATURA TEMPERATURA

— 2700K, 3000K, 4000K, 6000K
RGB, RGBW e CCT.

OPACIDADE OPACIDAD

— Transparente
— Opalino *Opal*

ACABAMENTO ACABADO

— Soft
— Rígido

*Sob consulta.



PRODUZIMOS NEONS À MEDIDA DA SUA NECESSIDADE
PRODUCIMOS NEONES HECHOS A LA MEDIDA DE SUS NECESIDADES

PERSONALIZE AS CARACTERÍSTICAS DO SEU NEON

PERSONALICE LAS CARACTERÍSTICAS DE SU NEÓN

MODELOS DISPONÍVEIS

MODELOS DISPONIBLES

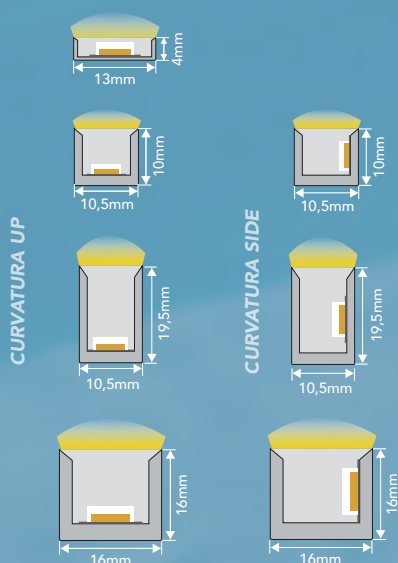

TEMPERATURA

TEMPERATURA

2700K, 3000K, 4000K, 6000K
 RGB, RGBW e CCT.

OPACIDADE

OPACIDAD

Transparente
 Opalino *Opal*

ACABAMENTO

ACABADO

Soft

**NEON
 HIL**



SERVIÇOS E PERSONALIZAÇÃO

SERVIÇOS MOTAKO

ESCOLHA O SERVIÇO QUE MELHOR SE ADAPTA AO SEU PROJETO:

- Personalização de fitas Neon, fitas Led e Perfis
- Desenvolvimento de Luminárias à medida
- HIL – Luminárias de Alto Impacto

Se pretende iluminação personalizada,
escolha os produtos e nós tratamos do resto!

ELIJA EL SERVICIO QUE MEJOR SE ADAPTE A SU PROYECTO

- Personalización de cintas de Neón, cintas Led y Perfiles
- Desarrollo de Luminarias a medida
- HIL – Luminarias de Alto Impacto

Si desea una iluminación personalizada,
elija los productos y nosotros nos encargamos del resto.

PERSONALIZAÇÕES

FITAS NEON / TIRAS NEÓN



Medida personalizável / Medida personalizable



Vulcanização / Vulcanización



Tamponagem / Tamponaje

FITAS LED / TIRAS LED



Corte de fita / Corte de tira



Personalização de cabo / Personalización del cable

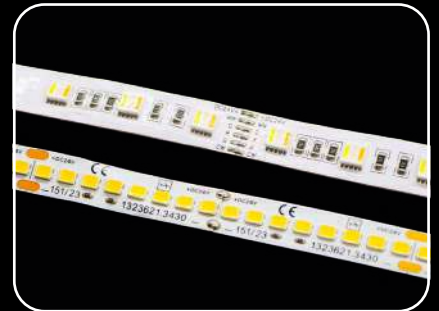

Soldadura / Soldadura

PERFIS / PERFILES

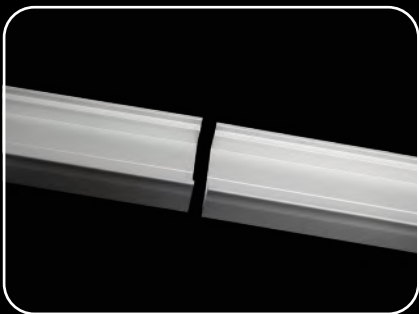

Corte de perfis / Corte de perfiles

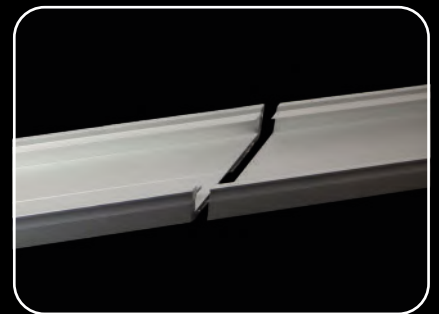

CONCEITOS | CONCEPTO



LÚMENS | LÚMENES

O fluxo luminoso é composto por toda a radiação que é emitida por uma fonte de luz em todas as direções e percebida pelo olho humano. A unidade de medida do fluxo luminoso é o lúmen (lm).

El flujo luminoso está compuesto por toda la radiación que emite una fuente de luz en todas direcciones y es percibida por el ojo humano. La unidad de medida del flujo luminoso es el lumen (lm).

CRI - ÍNDICE CROMÁTICO DA LUZ | ÍNDICE CROMÁTICO DE LA LUZ

O CRI (Colour Rendering Index) é o índice de reprodução cromática que representa o grau de fidelidade com que as fontes de luz revelam a cor dos objetos luminosos. O CRI proporciona um maior conforto visual, porque protege a visão e resulta numa melhor qualidade de saúde ocular.

El CRI (Colour Rendering Index) es el índice de reproducción cromática que representa el grado de fidelidad con el que las fuentes de luz revelan el color de los objetos luminosos. CRI Proporciona un mayor confort visual, ya que protege la visión y redundante en una mejor calidad de la salud ocular.

TEMPERATURA DE COR | TEMPERATURA DEL COLOR

A temperatura de cor ou CCT (Correlated Colour Temperature) de uma luminária é traduzida na cor de luz da mesma. Para designar a temperatura de cor é usada a escala Kelvin (K): quanto mais perto do espectro amarelo, mais quente (menos é o valor da escala de Kelvin), e quanto mais perto do azul, mais fria (maior é o valor na escala de Kelvin).

La temperatura de color o CCT (Correlated Color Temperature) de una luminaria se traduce en su color de luz. Para designar la temperatura del color, se utiliza la escala Kelvin (K): cuanto más cerca del espectro amarillo, más cálido (menor es el valor de la escala Kelvin) y cuanto más cerca del azul, más frío (cuanto mayor es el valor en el espectro Kelvin).

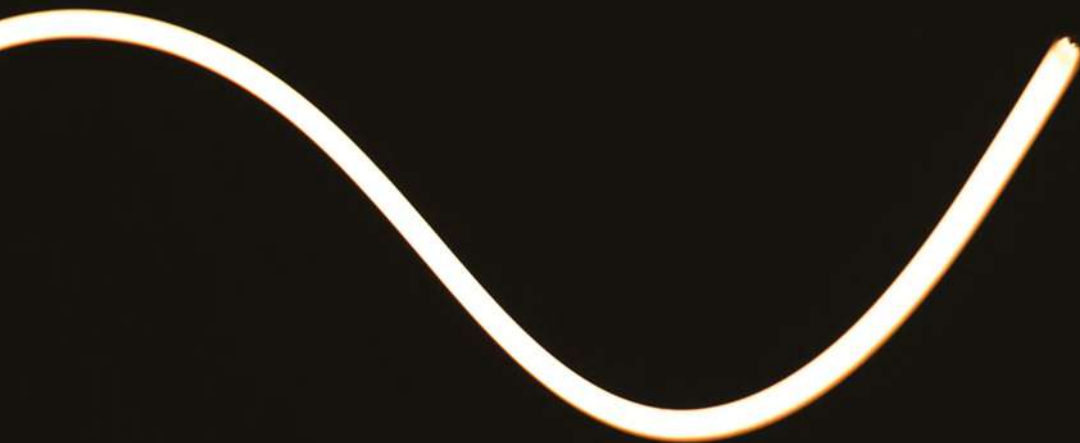

UGR - ÍNDICE DE ENCANDEAMENTO | ÍNDICE DE DESLUMBRAMIENTO

O UGR (Unified Galre Rating) é o índice de encandeamento unificado. Os valores de UGR são adotados na seguinte escala de valores: 13-16-19-22-25-28, em que 13 representa o grau de encandeamento mais baixo. O grau de encandeamento deve ser analisado consoante o espaço a ser iluminado.

El UGR (Unified Galre Rating) es el índice de deslumbramiento unificado. Los valores UGR se adoptan en la siguiente escala de valores: 13-6-19-22-25-28, donde 13 representa el menor grado de encadenamiento. Se debe analizar el grado de deslumbramiento en función del espacio a iluminar.

STEPS DE MACADAM

A consistência de cores pode ser definida como a capacidade de se manter a mesma tonalidade de cor entre duas fontes de luz. Os desvios de tonalidade de cor são avaliados e quantificados pelo SDCM (Standard Deviation color Matching) de Steps de MacAdam. Quanto menos Steps de MacAdam tiver a fonte de luz, mais difícil é a distinção de variação de cor.

La consistencia del color se puede definir como la capacidad de mantener el mismo tono de color entre dos fuentes de luz. Las desviaciones de tono de color se evalúan y cuantifican mediante el SDCM (Standard Deviation color Matching) de MacAdam Steps. Cuantos menos MacAdam Steps tenga la fuente de luz, más difícil será distinguir la variación de color.

COR RGB | COLOR RGB

O LED RGB é um conjunto de 3 cores encapsuladas: vermelho (R), verde (G) e azul (B). É possível ativar as 3 cores individualmente ou criar combinações, uma vez que é criado mais do que um led RGB, por um espectro luminoso de uma só cor. O resultado de maior combinação de cor RGB depende também da intensidade regulável de cada led.

El LED RGB es un conjunto de 3 colores encapsulados: rojo (R), verde (G) y azul (B). Es posible activar los 3 colores individualmente o crear combinaciones, ya que mediante un espectro de luz de un solo color se crea más de un LED RGB. El resultado de una mayor combinación de colores RGB también depende de la intensidad ajustable de cada LED.

CONCEITOS | CONCEPTO

DIM-TO-WARM

Dim-to-Warm é a capacidade de ajustar a cor do led enquanto fazemos dimming da fita. Consegue-se adquirir a cor de luz dos 3000K aos 1800K e vice-versa.

Dim to Warm es la capacidad de ajustar el color del LED mientras se atenúa la tira. Es posible adquirir color de luz desde 3000K hasta 1800K.

IP - ÍNDICE DE PROTEÇÃO | INDICE DE PROTECCIÓN

A sigla IP é um padrão internacional, norma IEC 60529 que representa o grau de proteção de uma luminária. O primeiro dígito do valor IP indica o nível de proteção que a luminária tem perante componentes sólidos externos. O segundo dígito do IP indica o nível de proteção que a luminária tem face à sua submersão em água.

Las siglas IP son una norma internacional, IEC 60529, que representa el grado de protección de una luminaria. El primer dígito del valor IP indica el nivel de protección que tiene la luminaria frente a componentes sólidos externos. El segundo dígito del IP indica el nivel de protección que tiene la luminaria frente a la inmersión en agua.

CLASSE DE PROTEÇÃO | CLASSE DE PROTECCIÓN

Existem três níveis de proteção que nos indicam a proteção que um equipamento detém contra choques elétricos. É classificado pela norma internacional IEC 61140 com os seguintes símbolos:

Existen tres niveles de protección que indican la protección que tiene un equipo contra descargas eléctricas. Está clasificado según la norma internacional IEC 61140 con los siguientes símbolos:



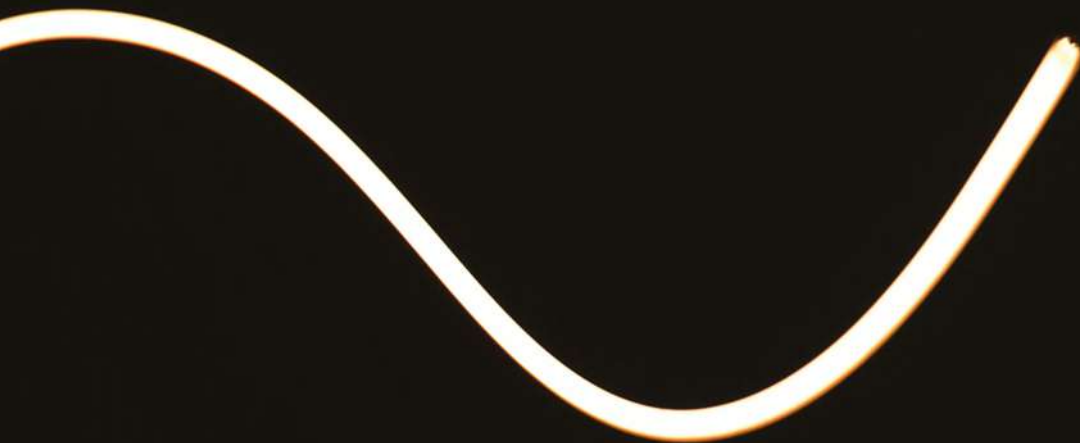

IK - GRAU DE IMPACTO | GRADO DE IMPACTO

O índice de proteção IK é uma classificação contra impactos que podem danificar o material, regido pela norma IEC 62262. Tem uma escala de 0 a 10, sendo o índice mais alto IK10.

El índice de protección IK es una clasificación frente a impactos que pueden dañar el material, regida por la norma IEC 62262. Tiene una escala de 0 a 10, siendo el índice más alto IK10.

ALTA EFICIÊNCIA | ALTA EFICIENCIA

Os produtos que permitem obter mais desempenho com menor consumo energético têm boa eficiência energética, assim consegue obter mais luz com menor gasto energético. Para saber quais os produtos mais eficientes pode consultar a etiqueta energética com uma escala de A a G, sendo A a melhor eficiência.

Los productos que te permiten obtener más rendimiento con menos consumo energético tienen una buena eficiencia energética, por lo que podrás obtener más luz con menos consumo energético. Para saber qué productos son más eficientes puedes consultar la etiqueta energética con una escala de la A a la G, siendo A la mejor eficiencia.

SMART HOME | CASA INTELIGENTE

SMART HOME é o termo que se dá a uma casa automatizada com controlo de iluminação e não só. Os produtos inteligentes podem ser controlados por diversos protocolos como DALI, ZIGBEE, CASAMBI, WI-FI, através de aplicações.

SMART HOME es el término que se le da a una casa automatizada con control de iluminación y más. Los productos inteligentes pueden ser controlados por diferentes protocolos como DALI, ZIGBEE, CASAMBI, WI-FI, a través de aplicaciones.

ICONOGRAFIA

ICONOGRAFÍA

Ao longo de todo o catálogo encontrará vários ícones referentes às propriedades de cada produto.

A lo largo de todo el catálogo encontrarás diversos iconos referentes a las propiedades de cada producto.

CARACTERÍSTICAS DO PRODUTO

CARACTERÍSTICAS DEL PRODUCTO



Nova tecnologia, R2R - Rolo a Rolo. As fitas contêm um PCB contínuo, sem uniões de soldadura.
Nueva tecnología, R2R (rollo a rollo). Las cintas contienen una PCB continua, sin uniones soldadas.



Eficiência Energética
Alta Eficiencia



Potência
Potencia



Tensão
Tensión



Corrente
Corriente



Índice de Proteção
Índice de Protección



Índice cromático da luz
Índice cromático de la luz



Tipo de LED
Tipo de LED



Quantidade de LED por metro
Número de LED por metro



Comprimento do rolo de fita led
Longitud del rollo de tira LED



Ligação máxima de fita
Conexión máxima de tira



O nosso serviço HIL: produção de neons e luminárias de alta proteção e alto impacto
Nuestro servicio HIL: producción de neones y luminarias de alta protección y alto impacto.



Temperatura de funcionamento
Temperatura de funcionamiento



Dimável ou não dimável
Regulable o no regulable



Comando por radiofrequência, USB ou wifi
Control por radiofrecuencia, USB o wifi



Direção de luz
Dirección de la luz



Material: Alumínio, cerâmica, aço inoxidável, plástico, inox, vidro, plástico (ABS), policarbonato
Material: Aluminio, cerámica, acero inoxidable, plástico, vidrio, plástico (ABS), policarbonato



Com possibilidade de corte à medida
Posibilidad de corte a medida



Dimensão do corte para perfis de encastramento
Dimensión de corte para perfiles empotrados

INFORMAÇÕES DE SEGURANÇA TÉCNICA

INFORMACIÓN TÉCNICA DE SEGURIDAD

	Densidade da fita de LED <i>Densidad de tira de LED</i>
	Fator potência <i>Factor de potencia</i>
	Ângulo de abertura <i>Ángulo de apertura</i>
	Resistência aos raios UV <i>Resistencia a los rayos UV</i>
	Durabilidade <i>Durabilidad</i>
	Fonte de alimentação ventilada <i>Fuente de alimentación ventilada</i>
	Aplicação: parede, teto <i>Aplicación: pared, techo</i>
	Instalação Interior / Exterior <i>Instalación Interior / Exterior</i>
	Capacidade de resistir ao contato com água salgada <i>Capacidad para resistir el contacto con agua salada</i>
	Capacidade de resistir ao contato com componentes químicos <i>Capacidad para resistir el contacto con componentes químicos</i>
	Equipamento contra-harmônicas, com fator de correção de potência ativo <i>Equipos contraarmónicos, con corrección activa del factor de potencia</i>
	Equipamento programável através de dip-switch <i>Equipos programable mediante dip-switch</i>
	Capacidade de resistir à exposição solar <i>Capacidad para resistir la exposición al sol.</i>
	Possibilidade de submersão em água até 2mt <i>Posibilidad de inmersión en agua hasta 2mt</i>

	Equipamento com ligação de terra / Equipamento sem ligação de terra <i>Equipos con conexión a tierra / Equipo sin conexión a tierra</i>
	Baseado na VDE0710-14, pode ser instalado dentro de um material inflamável tal como uma caixa de madeira. Determina a distância mínima entre a fonte e os laterais da caixa inflamável. <i>Basado en VDE0710-14, se puede instalar dentro de un material inflamable como una caja de madera. Determina la distancia mínima entre la fuente y los lados de la caja inflamable.</i>
	Proteção contra excesso de aquecimento para prevenir que a caixa em nenhum momento possa superar os 100°C / 110°C / 120°C, de modo a evitar possíveis incêndios. <i>Protección contra sobrecalentamiento para evitar que la caja supere los 100°C / 110°C / 120°C en cualquier momento, para evitar posibles incendios.</i>
	Adequado para montar directamente sobre superfícies inflamáveis tais como madeira (>2mm) <i>Apto para montaje directo sobre superficies inflamables como madera (>2 mm)</i>
	Enrolamentos separados (proteção no transformador entre o primário e o secundário) <i>Devanados separados (protección en transformador entre primario y secundario)</i>
	Proteção a isolamento de classe 2. O equipamento detém uma dupla camada de isolamento elétrico protegendo assim de um eventual choque elétrico aquando do contato físico com a parte elétrica do equipamento. <i>Protección de aislamiento clase 2. El equipo dispone de doble capa de aislamiento eléctrico, protegiéndolo así de posibles descargas eléctricas al entrar en contacto físico con la parte eléctrica del equipo.</i>
	Grau de proteção ao impacto
	Conformidade com as diretivas legais vigentes na Europa <i>Cumplimiento de las directivas legales vigentes en Europa</i>
	Numa fonte com o SELV integrado, a ocorrência de falhas não irá resultar em choques elétricos, pois está eletricamente separado da terra e dos outros sistemas e incorpora isolamentos elétricos adequados. <i>En una fuente de alimentación con SELV integrado, las fallas no provocarán descargas eléctricas, ya que está separada eléctricamente de la tierra y de otros sistemas e incorpora un aislamiento eléctrico adecuado.</i>



ILUMINAÇÃO ESPECIAL / *ILUMINACIÓN ESPECIAL*

Linea Tenseo	24	Tela Tensionada	30
PCB Flexível	28	Módulos Led	32

ILUMINAÇÃO AQUÁTICA / *ILUMINACIÓN ACUÁTICA*

Iluminação de Piscina	36
Iluminação de Lago	43
Fita Led Neon AQUA	45

MOBILIÁRIO / *MUEBLES*

2RLight:		Interruptores e Sensores	62
Sensores	52		
Fontes de Alimentação	61		

FITAS DE LED NEONS / *TIRAS DE LED DE NEÓN*

Introdução	67	Gama Neon Side	95	Gama Neon 230V	123
Gama Neon Up + Side	77	Gama Neon Aqua	107		
Gama Neon Up	85	Gama Neon Extra Long	113		

TUBO NEON / *NEÓN TUBO*

Neon UP	128
Neon SIDE	129

FITAS DE LED / *TIRAS DE LED*

Introdução	131	Regulação de Temperatura	237
Gama Standard	142	Gama Digital	245
Gama RGB	225	Iluminação Especial	255

FONTES DE ALIMENTAÇÃO / *FUENTES DE ALIMENTACIÓN*

Introdução	263	Fontes de Alimentação		Drivers Dimáveis	304
Fontes de Alimentação		Dimáveis	279		
Não Dimáveis	266	Drivers Não Dimáveis	289		

SMART HOME / *CASA INTELIGENTE*

Controlo RF	328	Mesh 2.4G	361	DMX	388
Casambi	340	Nexta	366	KNX	390
Dali	351	Zigbee	378	Amplificadores	394

PERFIS ARQUITETURAIS / *PERFILES ARQUITECTÓNICOS*

Sancas de Luz Indireta	405	Encastre em Cerâmica	445	Pavimento	483
Salientes	408	Barramento	451	Aplicação Especial	489
Encastre	429	Suspensão	475	Rodapé e Rodateto	502



ILUMINAÇÃO ESPECIAL

Iluminación Especial

LINEA TENSEO

LINHA LUZ INDIRECTA SUSPENSA | LÍNEA DE LUZ INDIRECTA

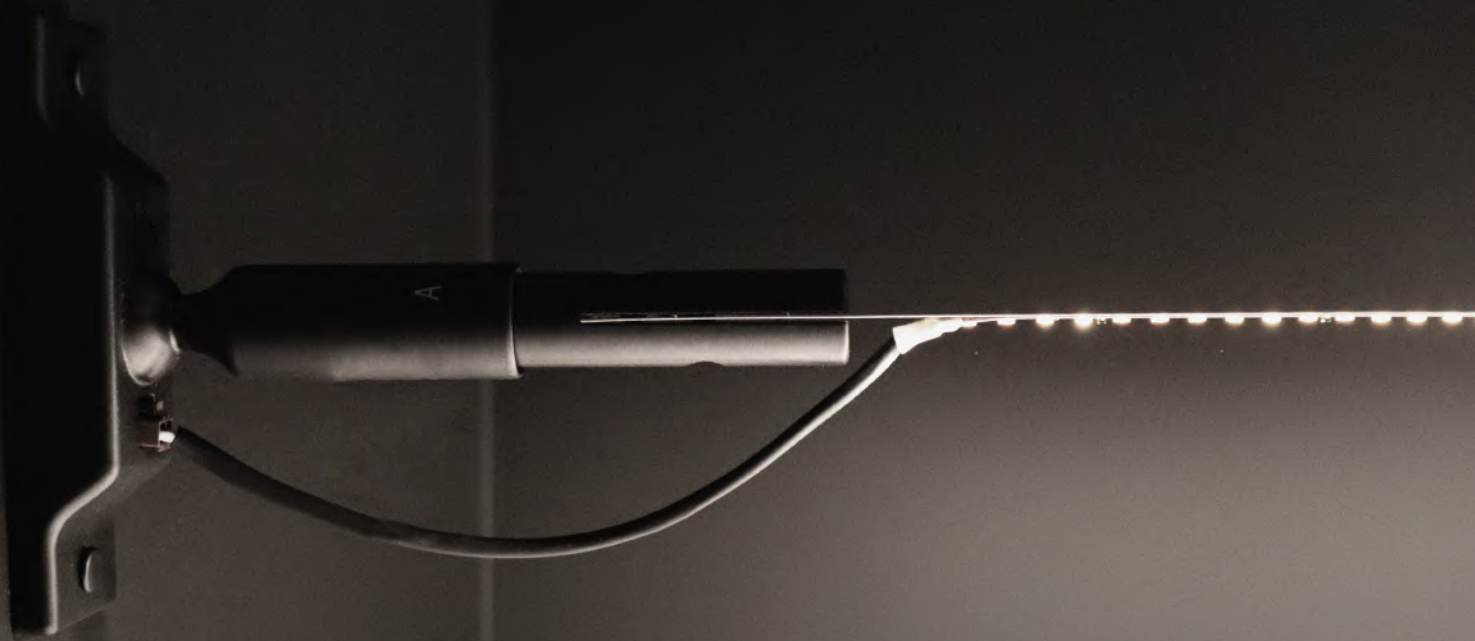

DESTAQUE | DESTACADO

Aplicação: Montras, Museus, Galerias de arte, Tetos em cúpula, Tendas de eventos.

Sistema de luz linear suspensa, liga 2 pontos em linha reta, permitindo criar uma infinidade de estilos criativos e sofisticados. Está disponível em 3 medidas, 6mt, 12mt e 20mt.

Aplicaciones: Escaparates, Museos, Galerías de arte, Techos abovedados, Carpas para eventos.

Sistema de iluminación lineal suspendida, conecta 2 puntos en línea recta, lo que permite crear una infinidad de estilos creativos y sofisticados. Está disponible en 3 tamaños, 6mt, 12mt y 20mt.

LUZ INDIRETA LINEA TENSEO IP20



	Ref.	Cor Color	Tensão Tensión	IP
13,5W m	191121.1327	2700K	24V	IP20
	191121.1330	3000K	24V	IP20
	191121.1340	4000K	24V	IP20
6m				
8,7W m	192121.827	2700K	24V	IP20
	192121.830	3000K	24V	IP20
	192121.840	4000K	24V	IP20
12m				
8,7W m	193121.827	2700K	24V	IP20
	193121.830	3000K	24V	IP20
	193121.840	4000K	24V	IP20
20m				



Vendido em kit completo, com suportes incluídos, pronto a ligar a 24V.

Se vende como kit completo, con soportes incluidos, listo para conectar a 24V.

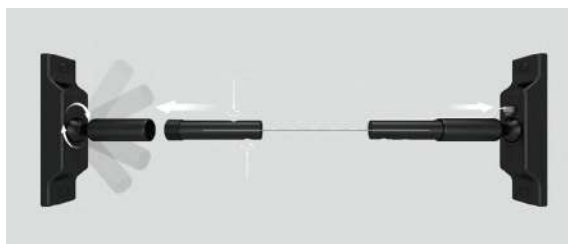

Instruções de montagem | Ângulo Mínimo 45°
Instrucciones de montaje | Ángulo mínimo 45°

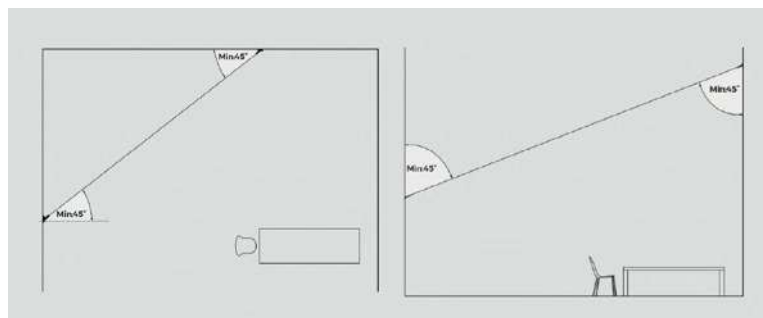

LINEA TENSEO NEON DUAL IP54

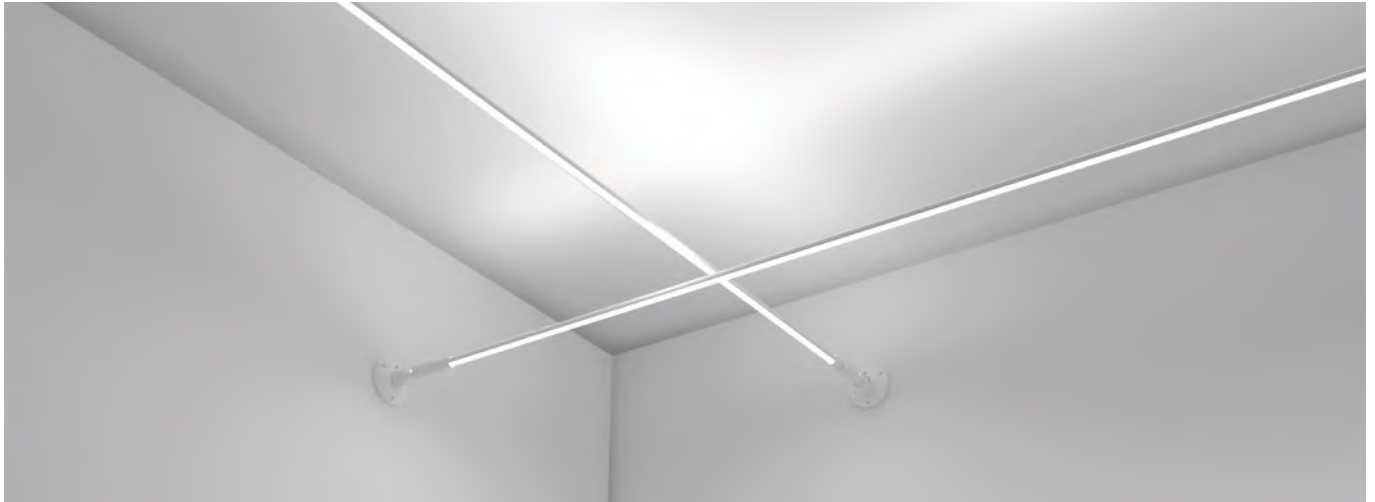

Modelo	Ref.	Cor Color	Tensão Tensión	IP	Lumens /w
LINEA TENSEO	196124.1027	2700K	24V	IP20	460Lm
	196124.1030	3000K	24V	IP20	466m
NEON DUAL	196124.1040	4000K	24V	IP20	495Lm

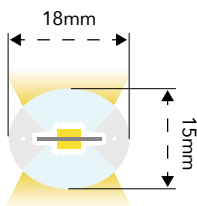
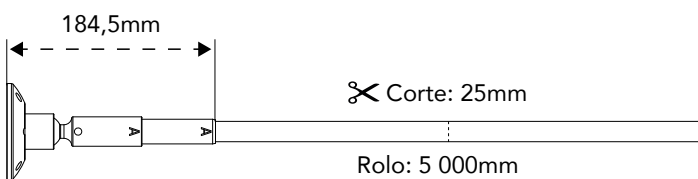

Vendido em kit completo, com suportes incluídos, pronto a ligar a 24V.
Se vende como kit completo, con soportes incluidos, listo para conectar a 24V.

LINEA TENSEO NEON 360° IP54

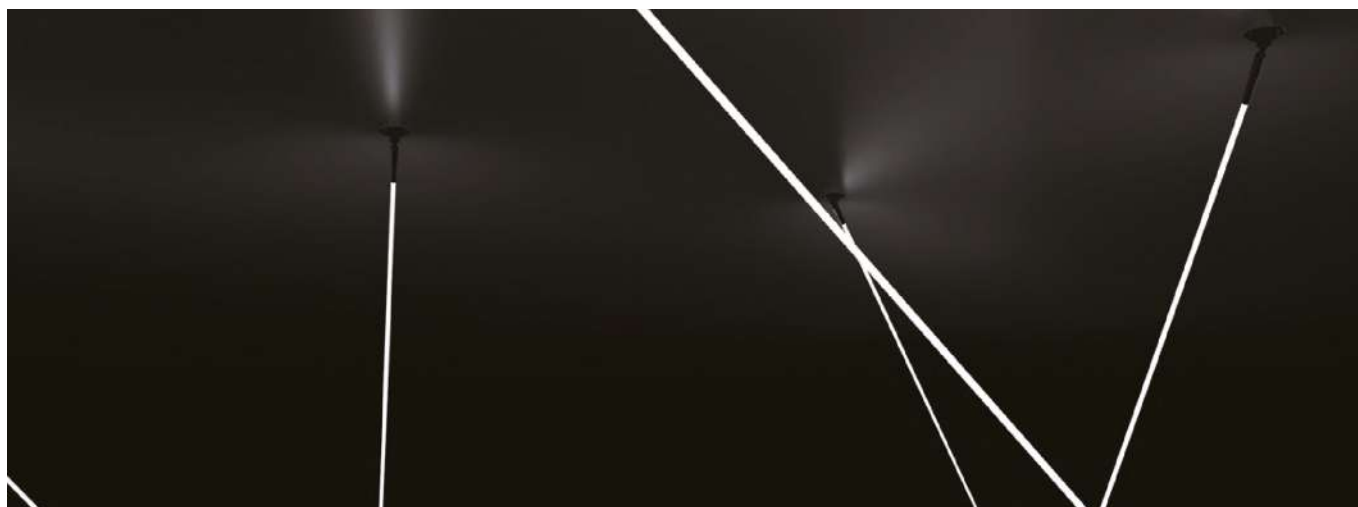

Modelo	Ref.	Cor Color	Tensão Tensión	IP	Lumens /w
LINEA TENSEO NEON 360°	194125.1327	2700K	24V	IP65	675Lm
	194125.1330	3000K	24V	IP65	700m
	194125.1340	4000K	24V	IP65	700Lm

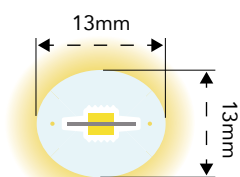
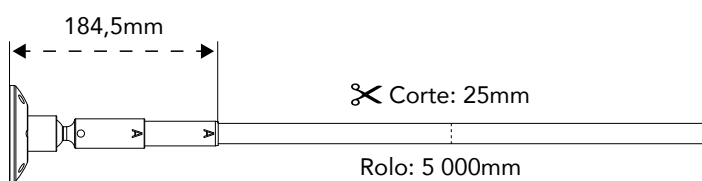

Vendido em kit completo, com suportes incluídos, pronto a ligar a 24V.
 Se vende como kit completo, con soportes incluidos, listo para conectar a 24V.

PLACA PCB FLEXÍVEL **MADRIX** 12W IP20

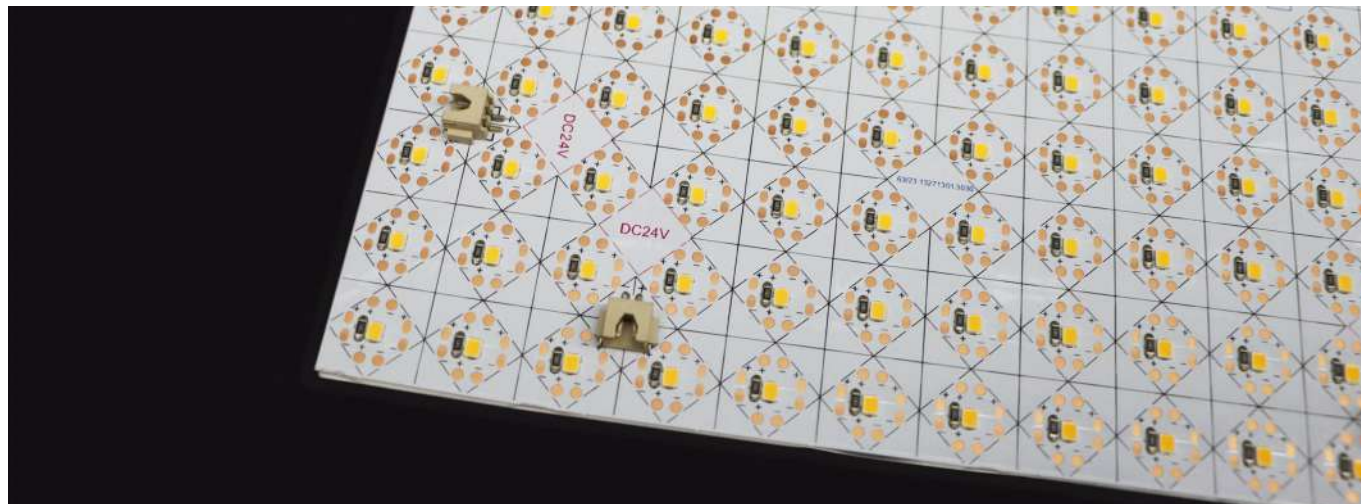

Modelo	Ref.	Cor Color	Tensão Tensión	IP	Lumens /placa	Lumens /w
MADRIX	13301301.1227	2700K	24V	IP20	1200Lm	100Lm
	13301301.1230	3000K	24V	IP20	1216Lm	101Lm
	13301301.1240	4000K	24V	IP20	1286Lm	107Lm
	13301301.1260	6500K	24V	IP20	1366Lm	114Lm

Também disponível nas opções: RGB, CCT e RGB Digital.

También disponible en las opciones: RGB, CCT y RGB Digital.

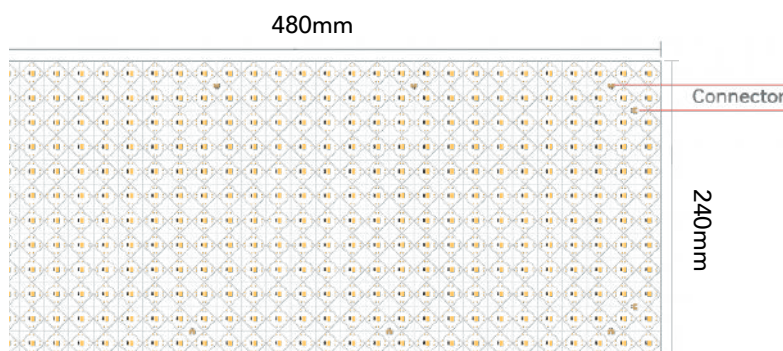

Possibilidade de ligar até 5 placas com apenas uma só ligação. Esta placa tem a vantagem de corte led-a-led. Cada placa inclui um conector e uma união.

Possibilidad de conectar hasta 5 placas con una sola conexión. Esta placa tiene la ventaja de ser cortada de led a led. Cada placa incluye un conector y una unión.

União | Union
Ref. 2241319.75 | Ref. 2241716.75

Ligador | Conector
Ref. 2241416.75

PLACA PCB FLEXÍVEL **MADRIX** 32W IP20



Modelo	Ref.	Cor Color	Tensão Tensión	IP	Lumens /placa	Lumens /w
MADRIX	13381301.3227	2700K	24V	IP20	2493Lm	77Lm
	13381301.3230	3000K	24V	IP20	2560Lm	80Lm
	13381301.3240	4000K	24V	IP20	2688Lm	84Lm
	13381301.3260	6500K	24V	IP20	2656Lm	96Lm

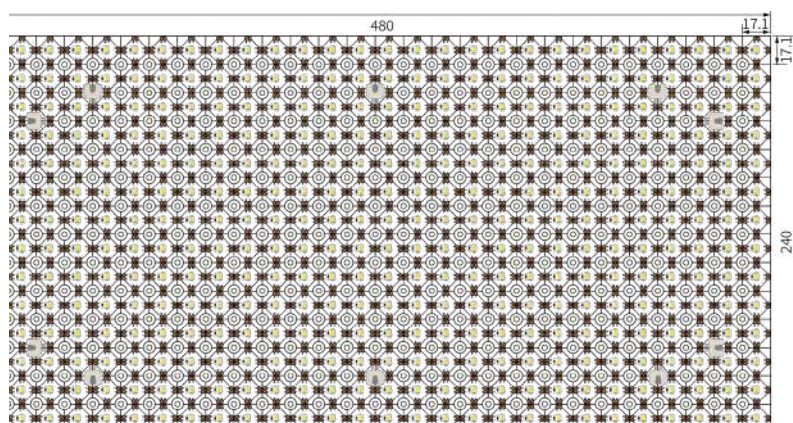

Possibilidade de ligar até 5 placas com apenas uma só ligação. Esta placa tem a vantagem de corte led-a-led. Cada placa inclui um conector e uma união.

Posibilidad de conectar hasta 5 placas con una sola conexión. Esta placa tiene la ventaja de ser cortada de led a led. Cada placa incluye un conector y una unión.

União | Union
Ref. 2241319.75 | Ref. 2241716.75

Ligador | Conector
Ref. 2241416.75

TELA TENSIONADA | PANTALLA TENSADA

A tela tensionada é um tecido estruturado sob tensão, fixado por perfis metálicos, podendo assumir diversos tamanhos e formatos.

As fitas led são posicionadas atrás da tela, projetando a luz de forma difusa e homogênea.

Com a possibilidade de cobrir áreas extensas e vários formatos, as suas aplicações são inúmeras, tanto em formas planas como tridimensionais, para além disso, pode escolher a fita Led, incluindo fitas RGB.

La pantalla tensada es un tejido estructurado bajo tensión, fijado por perfiles metálicos, que puede asumir diferentes tamaños y formatos.

Las tiras de led se colocan detrás de la pantalla, proyectando la luz de forma difusa y homogénea.

Con posibilidad de cubrir grandes superficies y varios formatos, sus aplicaciones son innumerables, tanto en formas planas como tri-dimensionales, además, puedes elegir la tira de led, incluidas las tiras RGB.

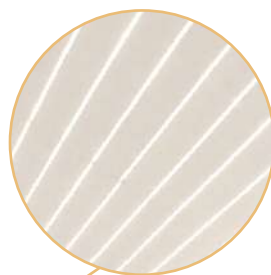

Aplicação das fitas led no interior da caixa de luz
Aplicación de tiras de led dentro de la caja de luz.





Ref.	Cor Color
27546.0370	7000K

7000K
8000K

0,36W

IP67

54
LM

170°

Unidade de venda - 200un
Unidad de venta - 200un

Ref.	Cor Color
276216.0770	7000K

7000K
8000K

0,72W

IP67

108
LM

170°

Unidade de venda - 100un
Unidad de venta - 100un

Ref.	Cor Color
277216.170	7000K

7000K
8000K

1,08W

IP67

162
LM

170°

Unidade de venda - 100un
Unidad de venta - 100un

Ref.	Cor Color
271215.0730	3000K
271215.0154	4000K

0,72W

IP67

66
LM

160°

Unidade de venda - 160un
Unidad de venta - 160un

Ref.	Cor Color
271215.0760	6000K

6000K
7000K

0,72W

IP67

69 LM

160°



Unidade de venda - 100un
Unidad de venta - 100un

Ref.	Cor Color
272215.260	6500K

6500K

2W

IP65

160 LM

170°



Unidade de venda - 100un
Unidad de venta - 100un

Ref.	Cor Color
274215.0565	6500K

6500K

5W

IP65

500 LM

170°



Unidade de venda - 50un
Unidad de venta - 50un

Ref.	Cor Color
271215.07CCT	2800K a 6500K

0,72W

IP65

63,5 LM

170°

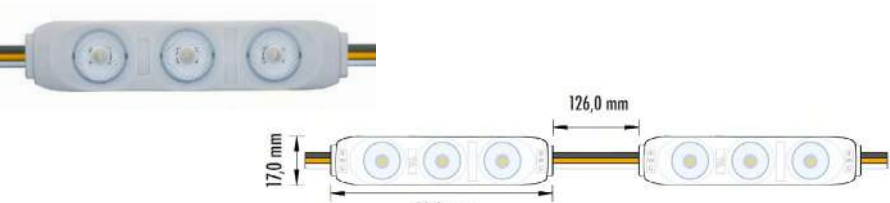

Unidade de venda - 100un
Unidad de venta - 100un

Ref.	Cor Color
271215.07RGB	RGB

0,72W

IP65

170°

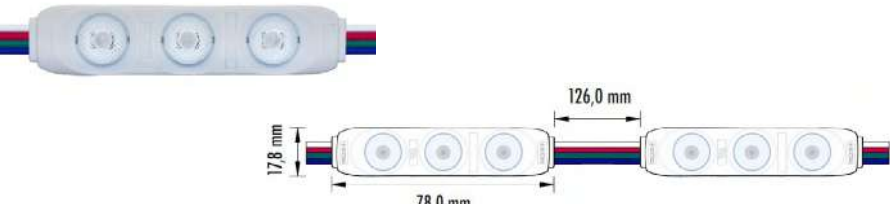

Unidade de venda - 100un
Unidad de venta - 100un

Disponível também em RGB+W. También disponible en RGB+W.



A modern swimming pool at night. The pool is illuminated with a warm, golden light, creating a shimmering effect on the water. The pool is set against a dark blue wall with a grid pattern. A wooden deck is visible in the foreground, and a small white object is on the left side. The overall atmosphere is serene and contemporary.

ILUMINAÇÃO AQUÁTICA

Iluminación Acuática

FAROL LED

LÂMPADA LED

PAR 56 RGB 15W IP68

LÁMPARA LED PAR 56 RGB 15W

15W IP68 3528 SMD 252 LED 12V AC/DC ABS CE

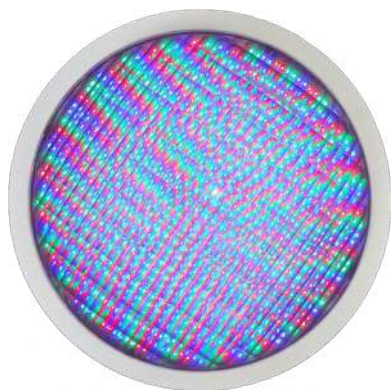

Ref. Cor Color Numens

15717.15RGB  R:625Nm
G:520Nm
B:467Nm
350Lm

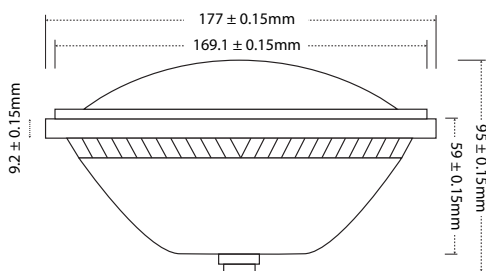

- _Lâmpadas compatíveis com todos os habitáculos;
- _Difusor em policarbonato e corpo em plástico;
- _Funciona com 2 fios.
- _Lámparas compatibles con todas los nichos;
- _Difusor de policarbonato y plástico corpo;
- _Funciona con 2 hilos.

LÂMPADA LED

PAR 56 RGB 20W IP68

LÁMPARA LED PAR 56 RGB 20W

20W IP68 3528 SMD 315 LED 12V AC/DC ABS CE

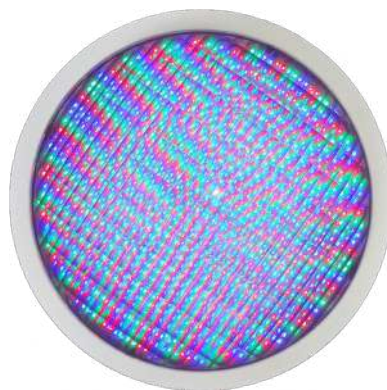

Ref. Cor Color Numens

15717.20RGB  R:625Nm
G:520Nm
B:467Nm
450Lm

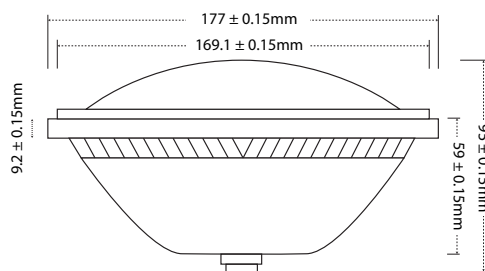

- _Lâmpadas compatíveis com todos os habitáculos;
- _Difusor em policarbonato e corpo em plástico;
- _Funciona com 2 fios.
- _Lámparas compatibles con todas los nichos;
- _Difusor de policarbonato y plástico corpo;
- _Funciona con 2 hilos.

SUGESTÕES | SUGERENCIAS

OPÇÃO 1

Controlador RGB Wifi+Tuya
Possibilidade de controlar por APP
Posibilidad de control por APP
Smartlife
Ref. 2130416.RGB
Pág. 42



OPÇÃO 2

Controlador RGB RF
Ref. 222417.RGB
Pág. 42





LÂMPADA LED
PAR 56 SLIM RGB 17W IP68
 LÁMPARA LED PAR 56 SLIM RGB 17W

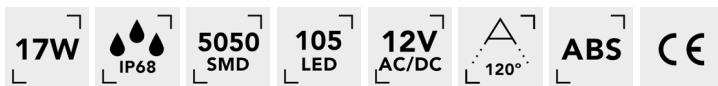

Ref. Cor Color Numens

1516617.17RGB  R:620-630Nm
 G:515-525Nm
 B:460-470Nm

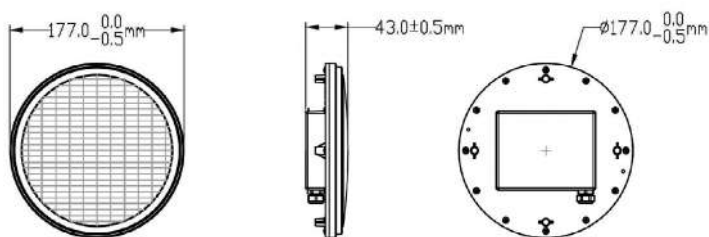

- _Mesmo diâmetro do PAR56 tradicional por isso pode ser adaptado ao buraco existente;
- _Parte traseira de nylon + fibra, capa de policarbonato anti-UV;
- _Comprimento do cabo: 1,5m;
- _Estrutura IP68 à prova de água;
- _Funciona com 4 fios, possibilitando o funcionamento com qualquer tipo de controlador ou protocolo de comunicação.

- _Mismo diámetro que la PAR56 tradicional por lo que puede ser adaptado al hueco existente;
- _Parte trasera de nylon + fibra, cubierta de policarbonato anti-UV;
- _Longitud del cable: 1,5 m;
- _Estructura estanca IP68;
- _Funciona con 4 hilos, lo que permite trabajar con cualquier tipo de controlador o protocolo de comunicación.

SUGESTÕES | SUGERENCIAS

Controlador RGB c/comando
 Controlador RGB c/mando
 Ref. 212217.1180
 Pág. 334



_O mesmo comando poderá controlar até 100 controladores através de programação.

_El mismo mando puede controlar hasta 100 controladores a través de la programación.

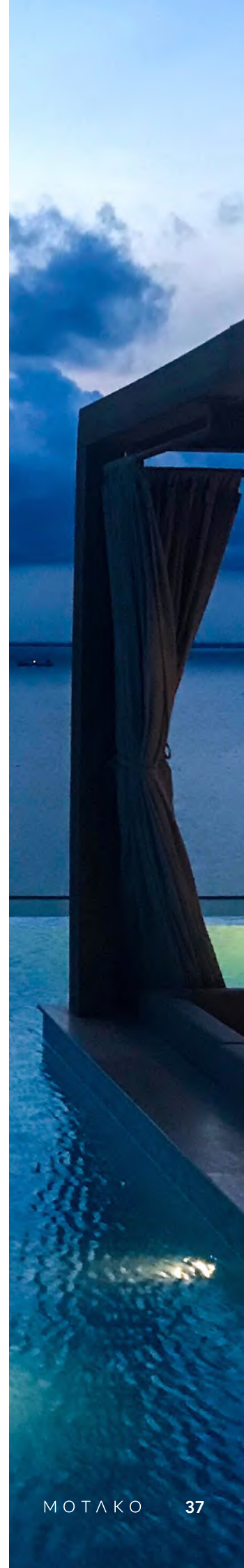

ILUMINAÇÃO AQUÁTICA | ILUMINACIÓN ACUÁTICA
 PROJETO DE SUPERFÍCIE PISCINA

PROJETO DE SUPERFÍCIE RGB 25W (com 4 fios) IP68
PROYECTOR DE SUPERFÍCIE RGB 25W (com 4 hilos)

25W
IP68
ABS
12V DC
RGB
120°
CE



Ref.	Cor Color	Lumens
151317.25RGB	RGB	R:621-625 Nm G:518-520 Nm B:464-467 Nm

_ Funciona com 4 fios
 _ Funciona com 4 hilos

CONTROLADOR RF RGBW

Ref. 211244.4RGBW

IP67
12-24 VDC
4 CANAIS
1A CANAL
PL
CE
NOVO

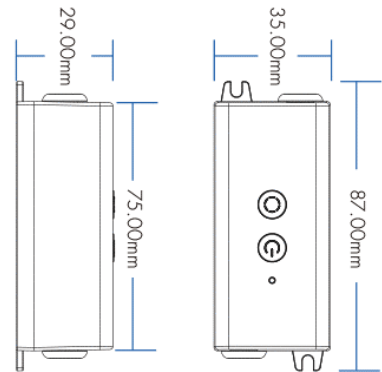

- _ Controlador recomendado para o projeto de piscina RGB, à prova de água com 2 botões.
- _ Ideal para controlar RGB, RGB+W, RGBW, 4xDim, controle de temperatura de cor.
- _ Permite criar cenários e horários de arranque para cada cenário.
- _ Controlador recomendado para el proyector de piscina RGB con control vía App y acceso remoto vía Bluetooth.
- _ Ideal para controlar RGB, RGB+W, RGBW, 4xDim, Control de temperatura de color;
- _ Le permite crear escenarios y horas de inicio para cada escenario.

*Comandos sugeridos | Comandos sugeridos
 REF.: 2120244.DIM; 2121244.DIM; 2120244.RGBW; 2121244.RGBW; 2120244.RG-B+W+W; 2119744.8RGBW; 2129744.8DIM; 213144.2CH; 2120178.4PT / 4BR

PROJETO DE SUPERFÍCIE IP68
 PROYECTOR DE SUPERFÍCIE

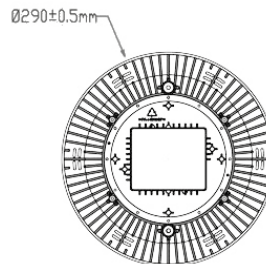
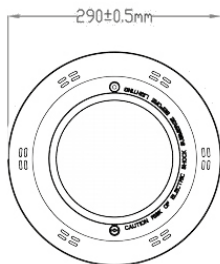

Ref.	Cor Color	Lumens				
1517717.2560	6000k	2700 Lm	25W	12V AC	2835 SMD	240 LED

Ref.	Cor Color	Numens			
1517717.24RGB	RGB	R:621-625 Nm G:518-520 Nm B:464-467 Nm	24W	12V AC	18 LED

_Funciona com 2 fios
 _Funciona con 2 hilos

SUGESTÕES | SUGERENCIAS

Controlador RGB c/comando
 Controlador RGB c/mando
 Ref. 222417.RGB
 Pág. 42



_Máximo até 10 lâmpadas;
 _Este controlador deverá ser programado com as lâmpadas.
 _Máximo hasta 10 lámparas;
 _Este controlador debe programarse con las lámparas.

FAROL LED

LÂMPADA LED PAR 56 20W IP68
LÁMPARA LED PAR 56 20W

20W
IP68
192 LED/m
2835 SMD
ABS
12V AC/DC
120°
CE



Ref.	Cor Color	Lumens
151317.2030	3000K	1800 Lm
151317.2060	6000K	1800 Lm

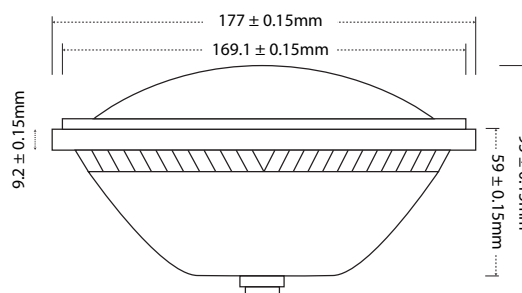

_Lâmpadas compatíveis com todos os habitáculos;
_Difusor em policarbonato e corpo em plástico.

_Lámparas compatibles con todas los nichos;
_Difusor de policarbonato y cuerpo de plástico.



HABITÁCULOS PARA LÂMPADA LED PAR 56 NICHO PARA LÂMPARA LED PAR 56

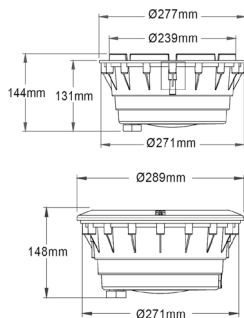
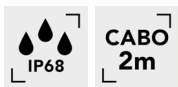

_P/ Piscinas de betão, inclui 2mt de cabo de ligação (vulcanizado no projetor).
 _P/Piscinas de concreto, incluye 2m de cable de conexión (vulcanizado en el Proyector).

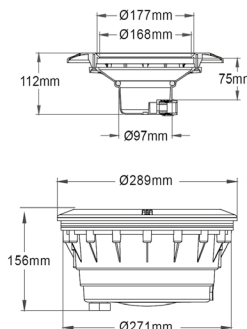

_P/ Piscinas de tela, com borracha de proteção e parafusos em inox.
 _P/ Piscinas de tela, con protección de goma y tornillos de acero inoxidable.

FONTE VTS IP67 FUENTE VTS

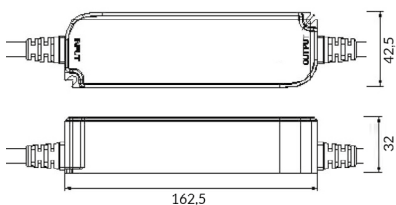

Consulte a ficha completa do produto na Pág. 336



CONTROLADOR RGB



Ref. 222417.RGB

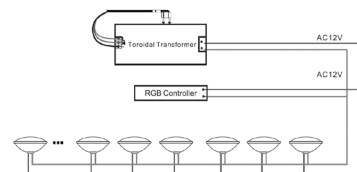

_Este controlador deverá ser programado com as lâmpadas. (Máx. até 10 lâmpadas)

_Este controlador debe programarse con las lámparas. (Máx. hasta 10 Lámparas)

CONTROLADOR PRINCIPAL + COMANDO + PAINEL DE CONTROLO



Ref. 2139216.RGB



_Permite entre 1-20 lâmpadas em funcionamento, com potência máxima de 600W;
 _Distância de conexão e controlo remoto: 50mt;
 _Controlador síncrono RGB 100%;
 _O controlador dispõe de 20 tipos de modos de iluminação.

_Permite entre 1 y 20 lámparas en funcionamiento, con una potencia máxima de 600W.
 _Distancia de conexión y control remoto: 50mt;
 _Controlador síncrono RGB 100%;
 _El controlador dispone de 20 tipos de modos de iluminación.

Referência alternativa:



Ref. 2130416.RGB

SINCRONIZAÇÃO DE LÂMPADAS PAR 56 COM FITAS DE LED SINCRONIZACIÓN DE LÁMPARAS PAR 56 CON TIRAS LED



CONTROLADOR/DECODER

Ref. 222416.4180



Este decoder permite controlar fitas de led e Led Neons através do controlador 222417.RGB (controlador de lâmpadas PAR56), conseguindo o controlo de lâmpadas PAR56 em sincronismo com as Fitas de led e Led Neons.

Este decodificador permite controlar tiras LED y Neóns LED a través del controlador 222417.RGB (controlador Lámparas PAR56), logrando el control de lámparas PAR56 en sincronismo con las tiras LED y Neóns Led.

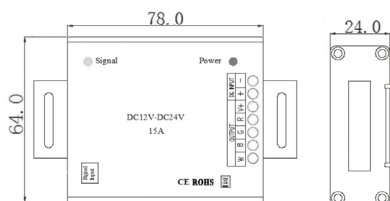

PROJETOR LED LAGO 5W IP68 PROYECTOR LED LAGO 5W



Ref.	Cor Color	Lumens
1512127.560	6000K	450 Lm

_Em inox 316 e Vidro temperado transparente de espessura 8,0 mm;
_Fixação de suporte com forte resistência ao impacto;
_Design de circuito de driver de tensão constante, fonte de alimentação de entrada DC24V;

_En acero inoxidable 316 y vidrio templado transparente de 8,0 mm de espesor;
_Soporte de fijación con fuerte resistencia al impacto;
_Diseño de circuito de controlador de voltaje constante, fuente de alimentación de entrada DC24V;



Ref.	Cor Color	Numens
1512227.5RGB	RGB	R: 620-630 Nm G: 515-525 Nm B: 460-470 Nm 130Lm

_Os 3 leds RGB encapsulados num só led, tem a vantagem de criar uma linha de luz de cor uniforme; Funciona com 4 fios.

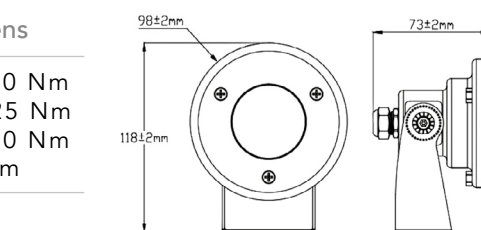

_Los 3 LED RGB encapsulados en un solo LED, tienen la ventaja de crear una línea de color uniforme; Funciona con 4 hilos.

PROJETOR LED LAGO 12W IP68 PROYECTOR LED LAGO 12W



Ref.	Cor Color	Lumens
1512327.1360	6000K	1100 Lm

_Funciona com 4 fios. | Funciona con 4 hilos.

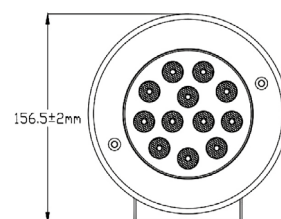

Ref.	Cor Color	Numens
1512427.12RGB	RGB	R: 620-630 Nm G: 515-525 Nm B: 460-470 Nm

_Funciona com 4 fios. | Funciona con 4 hilos.

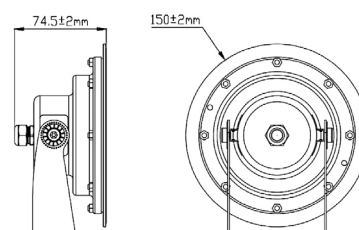





NEON AQUA

Néon Acuático

NEON UP **HIDRA** - PISCINA 10W IP68

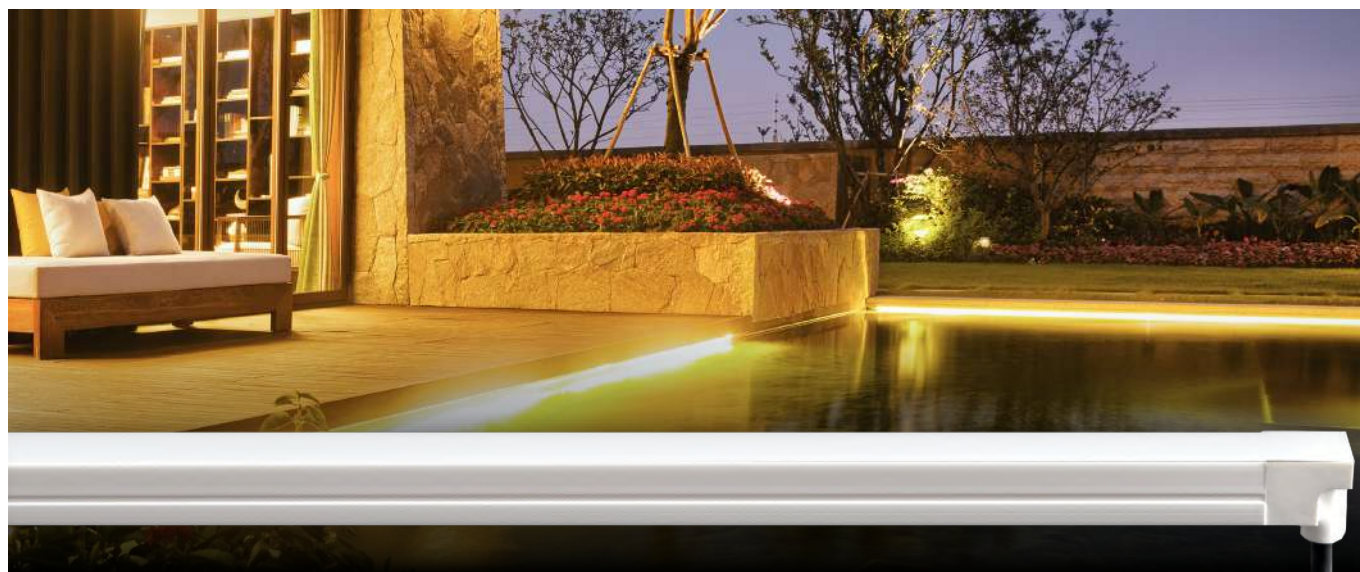

Modelo	Ref.	Cor Color	Tensão Tensión	IP	Lumens/ mt
HIDRA	13251227.1027	2700K	24V	IP68	616Lm
L70B10	13251227.1030	3000K	24V	IP68	655Lm
54000H	13251227.1040	4000K	24V	IP68	698Lm
2 Steps MacAdam	13251227.1065	6500K	24V	IP68	637Lm
L80	13268227.10RGB	RGB	24V	IP68	R:56Nm G:182Nm B:35Nm
30000H 1BIN					

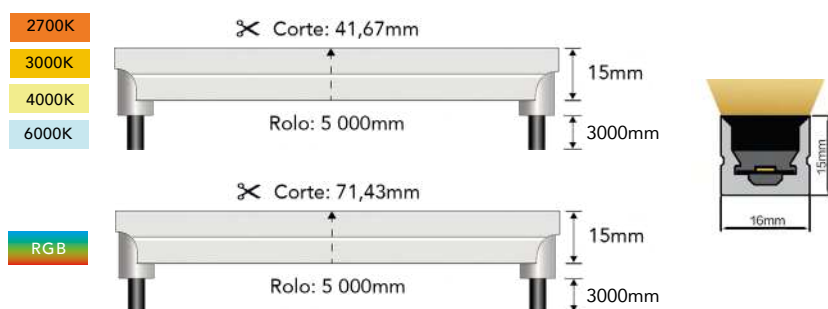

Possibilita uma linha de luz contínua na união de duas fitas resultante da saída inferior do cabo.

Permite una línea continua de luz en la unión de dos tiras resultantes de la salida inferior del cable.



Não inclui fixadores nem topos.
No incluye fijador ni tapas.

ACESSÓRIOS RECOMENDADOS ACCESORIOS RECOMENDADOS

Tampa final
Tapa final
Ref. 2219253

Calha fixadora PL 1mt
Perfil de fijación PL 1mt
Ref. PF152PL



Personalização de cabo só é feita sob encomenda à fábrica.*
La personalización del cable solo se realiza mediante pedido de fábrica.*

Este modelo tem disponível as seguintes saídas de cabo: | Este modelo dispone de las siguientes salidas de cable:



*Sujeito a confirmação de prazo de entrega.
Sujeto a confirmación del tiempo de entrega.

NEON UP **DAFNE** - PISCINA 10W IP68



Modelo	Ref.	Cor Color	Tensão Tensión	IP	Lumens /mt	Lumens /w
DAFNE 54000H	1322127.1030	3000K	24V	IP68	375Lm	38Lm
	1322127.1040	4000K	24V	IP68	410Lm	41Lm
	1322127.1060	6000K	24V	IP68	375Lm	38Lm
DAFNE RGB	1322127.10RGB	RGB	24V	IP68	R:54Nm G:201Nm B:40Nm	

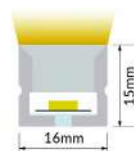
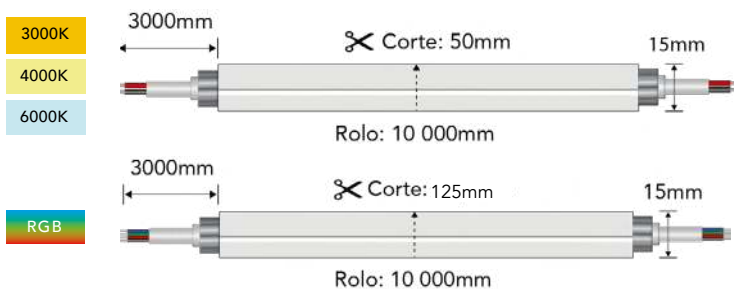

Este modelo standard tem saída de cabo de topo.
Este modelo estándar tiene una salida de cable superior.



ACESSÓRIOS RECOMENDADOS | ACCESORIOS RECOMENDADOS

<p>Tampa final Tapa final Ref. 2219253</p> 	<p>Calha fixadora PL 1mt Perfil de fijación PL 1mt Ref. PF152PL</p> 
--	---

Personalização de cabo só é feita sob encomenda à fábrica.*

La personalización del cable solo se realiza mediante pedido de fábrica.*

Não inclui fixadores nem topos.

No incluye fijador ni tapas.

*Sujeito a confirmação de prazo de entrega. Sujeto a confirmación del tiempo de entrega.

NEON UP SETEBOS - PISCINA IP68

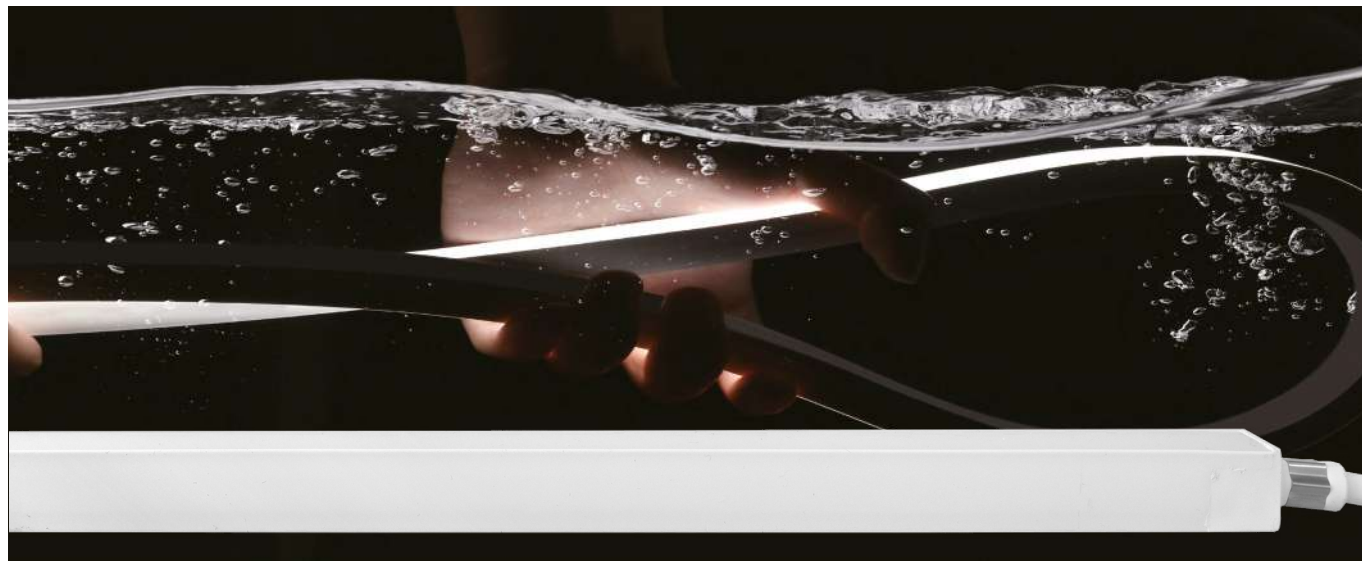

Modelo	Ref.	Cor Color	Tensão Tensión	Lumens /mt	Potência /mt	Rolo Rollo
	136.0527	2700K	24V	240Lm	5W	20mt
	136.1027	2700K	24V	480Lm	10W	15mt
	136.1527	2700K	24V	720Lm	15W	12mt
	136.0530	3000K	24V	245Lm	5W	20mt
	136.1030	3000K	24V	490Lm	10W	15mt
	136.1530	3000K	24V	735Lm	15W	12mt
	136.0540	4000K	24V	270Lm	5W	20mt
SETEBOS NEON UP	136.1040	4000K	24V	540Lm	10W	15mt
	136.1540	4000K	24V	810Lm	15W	12mt
	136.0565	6500K	24V	250Lm	5W	20mt
	136.1065	6500K	24V	500Lm	10W	15mt
	136.1565	6500K	24V	750Lm	15W	12mt
	136.07RGB	RGB	24V	172Nm	7W	15mt
	136.09RGB	RGB	24V	233Nm	9W	13mt
	136.12RGB	RGB	24V	311Nm	12W	12mt



ACESSÓRIOS RECOMENDADOS
ACCESORIOS RECOMENDADOS

Calha fixadora PL 1mt
Perfil de fijación PL 1mt
Ref. PF196PL



Calha fixadora para encastrar PL 1mt
Perfil de fijación empotrado PL 1mt
Ref. PF296PL



Fixador 1617
Fijador 1617
Ref. 2226272

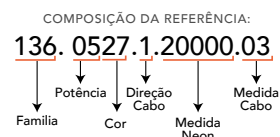
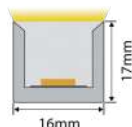
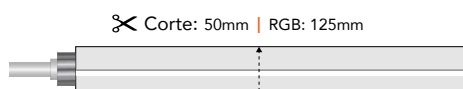

Este modelo tem disponível as seguintes saídas de cabo: | Este modelo dispone de las siguientes salidas de cable:



Fita sob encomenda. Tira por encargo.

CARACTERÍSTICAS DE PERSONALIZAÇÃO
FUNCIONES DE PERSONALIZACIÓN

- a. Comprimento da fita neon. Longitud de la cinta de neón.
- b. Comprimento do cabo. Tamaño del cable.
- c. Direção do cabo. Dirección del cable.

Medida de rolo disponível até 20mt. Tamaño de rolo disponible un máximo de 20 metros.

NEON SIDE TELESTO - PISCINA IP68



Modelo	Ref.	Cor Color	Tensão Tensión	Lumens /mt	Potência /mt	Rolo Rollo
NEON SIDE TELESTO	135.0527	2700K	24V	270Lm	5W	20mt
	135.1027	2700K	24V	540Lm	10W	15mt
	135.1527	2700K	24V	810Lm	15W	12mt
	135.0530	3000K	24V	275Lm	5W	20mt
	135.1030	3000K	24V	550Lm	10W	15mt
	135.1530	3000K	24V	825Lm	15W	12mt
	135.0540	4000K	24V	310Lm	5W	20mt
	135.1040	4000K	24V	620Lm	10W	15mt
	135.1540	4000K	24V	930Lm	15W	12mt
	135.0565	6500K	24V	280Lm	5W	20mt
	135.1065	6500K	24V	560Lm	10W	15mt
	135.1565	6500K	24V	840Lm	15W	12mt
	135.07RGB	RGB	24V	198Nm	7W	15mt
	135.09RGB	RGB	24V	267Nm	9W	13mt
	135.12RGB	RGB	24V	357Nm	12W	12mt

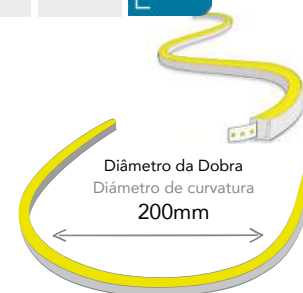

ACESSÓRIOS RECOMENDADOS
ACCESORIOS RECOMENDADOS

Calha fixadora PL 1mt
Perfil de fijación PL 1mt
Ref. PF196PL

Calha fixadora para encastrar PL 1mt
Perfil de fijación empotrado PL 1mt
Ref. PF296PL

Fixador 1617
Fijador 1617
Ref. 2226272

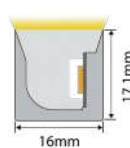
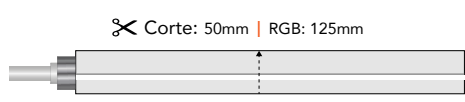

COMPOSIÇÃO DA REFERÊNCIA:
135.0527.1.20000.03

↓ Família ↓ Potência ↓ Direção Cabo ↓ Medida Neon ↓ Medida Cabo

Este modelo tem disponível as seguintes saídas de cabo: | Este modelo dispone de las siguientes salidas de cable:



Fita sob encomenda. Tira por encargo.

CARACTERÍSTICAS DE PERSONALIZAÇÃO
FUNCIONES DE PERSONALIZACIÓN

1. Comprimento da fita neon. Longitud de la cinta de neón.
2. Comprimento do cabo. Tamaño del cable.
3. Direção do cabo. Dirección del cable.

Medida de rolo disponível até 20mt. Tamaño de rollo disponible un máximo de 20 metros.

NEON SIDE **LARISSA** - PISCINA 10W IP68



Modelo	Ref.	Cor Color	Tensão Tensión	IP	Lumens /mt	Lumens /w
LARISSA	1314117.1030	3000K	24V	IP68	285Lm	28Lm
	1314117.1040	4000K	24V	IP68	272Lm	27Lm
	1314117.1060	6000K	24V	IP68	281Lm	28Lm
LARISSA RGB	1314117.10RGB	RGB	24V	IP68	R:36Nm G:130Nm B:24Nm	

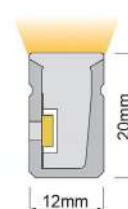
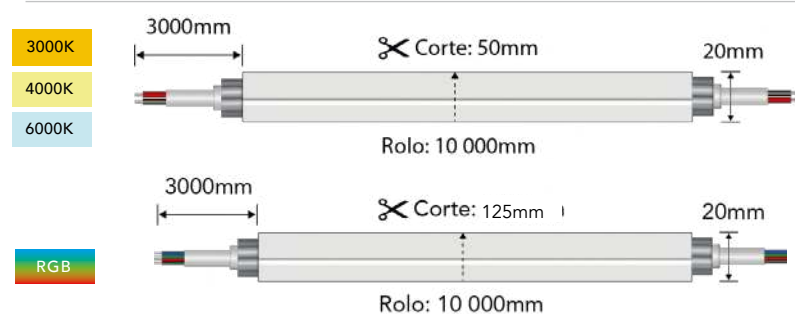
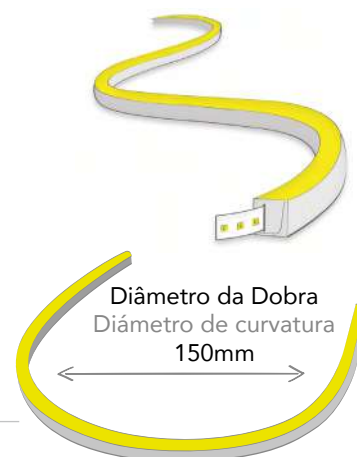

Este modelo standard tem saída de cabo de topo.
Este modelo estándar tiene una salida de cable superior.

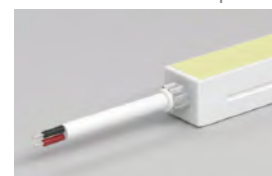

ACESSÓRIOS RECOMENDADOS | ACCESORIOS RECOMENDADOS

Tampa final
Tapa final
Ref. 2214226



Calha fixadora flexível Inox 0,5mt
Perfil de fijación flexible de acero inoxidable 0,5mt
Ref. PF1511X



Personalização de cabo só é feita sob encomenda à fábrica.*

La personalización del cable solo se realiza mediante pedido de fábrica.*

Não inclui fixadores nem topos.

No incluye fijador ni tapas.

*Sujeito a confirmação de prazo de entrega. Sujeto a confirmación del tiempo de entrega.

INOVAÇÃO E DESIGN | INNOVACIÓN Y DESIGN

MOBILIÁRIO

Muebles



A 2Rlight distingue-se pela sua oferta de produto que vem simplificar a tarefa de iluminar o seu mobiliário. Esta marca tem grande diversidade de produtos, tais como, sensores, fontes de alimentação, perfis com fita led, tomadas, focos e acessórios de decoração.

2Rlight se distingue por su oferta de productos que simplifican la tarea de iluminar sus muebles. Esta marca cuenta con una gran diversidad de productos, tales como sensores, fuentes de alimentación, perfiles con cinta LED, enchufes, focos y accesorios de decoración.



SENSOR DE PORTA 24V

SENSOR DE PUERTA 24V



Ref. 06.03001



_Sensor funciona sob o sistema de abertura e fecho de porta;
_Sistema de ligar e desligar com desvanecimento;
_Distância de deteção: 5~8cm;
_Aplicação: Encastre/Superfície.

_El sensor funciona mediante el sistema de apertura y cierre de la puerta;
_Sistema de encendido y apagado con atenuación;
_Alcance de detección: 5~8cm;
_Aplicación: Empotrar/Superficie.

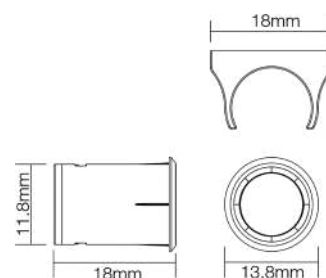

Medida do Cabo:
Medida del cable
200cm

SENSOR DE PORTA DUPLA 24V

SENSOR DE PUERTA DOBLE 24V



Ref. 06.03002



_Sensor funciona sob o sistema de abertura e fecho de porta dupla;
_Sistema de ligar e desligar com desvanecimento;
_Distância de deteção: 3~6cm;
_Aplicação: Encastre/Superfície.

_El sensor funciona mediante el sistema de apertura y cierre de la puerta doble;
_Sistema de encendido y apagado con atenuación;
_Alcance de detección: 3~6cm;
_Aplicación: Empotrar/Superficie.

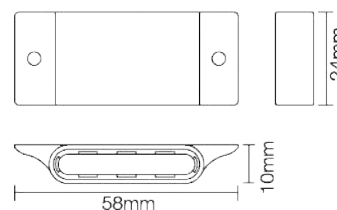

Medida do Cabo:
Medida del cable
200cm

ACESSÓRIOS RECOMENDADOS | ACCESORIOS RECOMENDADOS

Derivador p/ fita e sensor
Derivador p/ tira y sensor
Ref. 08.01001



Derivador para 4 sensores
Derivador para 4 sensores
Ref. 08.02001



Cabo para soldar à fita 1500mm
Cable para soldar a la cinta
Ref. 09.01001



*Os sensores presentes necessitam sempre de operar com um derivador.
Los sensores presentes siempre deben funcionar con un derivador.

SENSOR DE APROXIMAÇÃO 24V

SENSOR DE PROXIMIDAD 24V



Ref. 06.04001



- _Sensor funciona sob o sistema de aproximação de mão;
- _Sistema de ligar e desligar com desvanecimento;
- _Distância de deteção: 5~8cm;
- _Aplicação: Encastre/Superfície.

- _El sensor funciona mediante el sistema de proximidad de la mano;
- _Sistema de encendido y apagado con atenuación;
- _Alcance de detección: 5~8cm;
- _Aplicación: Empotrar/Superficie.

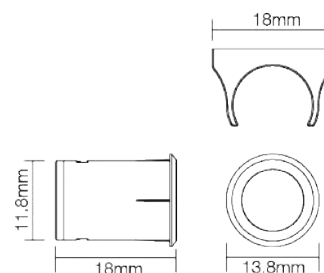

Medida do Cabo:
Medida del cable
200cm

SENSOR TOUCH 24V

SENSOR DE TOQUE 24V



Ref. 06.05001



- _Sensor funciona sob o sistema touch;
- _Sistema de ligar e desligar com desvanecimento;
- _ON/OFF / Dimmer;
- _Aplicação: Encastre/Superfície.

- _El sensor funciona mediante el sistema de toque;
- _Sistema de encendido y apagado con atenuación;
- _ON/OFF/Dimmer;
- _Aplicación: Empotrar/Superficie.

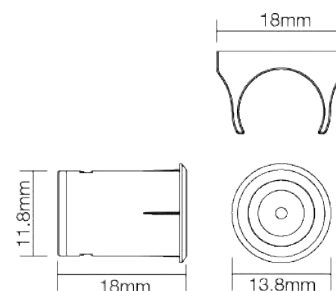

Medida do Cabo:
Medida del cable
200cm

SENSOR DE MOVIMENTO 24V

SENSOR DE MOVIMIENTO 24V



Ref. 06.06003



- _Sensor funciona sob o sistema de movimento;
- _Distância de deteção: 1~3m;
- _Aplicação: Encastre/Superfície.

- _El sensor funciona mediante el sistema de movimiento;
- _Alcance de detección: 1~3m;
- _Aplicación: Empotrar/Superficie.

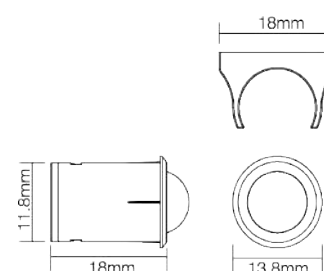

Medida do Cabo:
Medida del cable
200cm

ACESSÓRIOS RECOMENDADOS | ACCESORIOS RECOMENDADOS

Derivador p/ fita e sensor
Derivador p/ tira y sensor
Ref. 08.01001



Derivador para 4 sensores
Derivador para 4 sensores
Ref. 08.02001



Cabo para soldar à fita 1500mm
Cable para soldar a la cinta
Ref. 09.01001



*Os sensores presentes necessitam sempre de operar com um derivador.
Los sensores presentes siempre deben funcionar con un derivador.

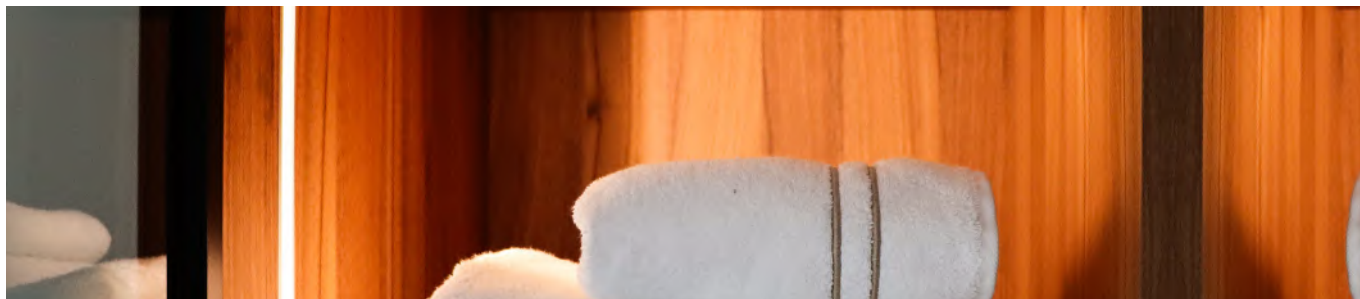

SENSOR DE PORTA 12-24V

SENSOR DE PUERTA 12-24V



Ref. 19.03001

12-24
VDC

IP20

PL

NOVO
NUEVO

- _ Sensor funciona sob o sistema de porta;
- _ Distância de deteção: 5~8cm;
- _ Aplicação: Encastre.

- _ El sensor funciona mediante el sistema de puerta;
- _ Alcance de detección: 5~8cm;
- _ Aplicación: Empotrar.

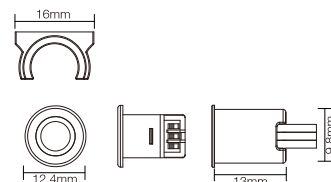

SENSOR TOUCH 12-24V

SENSOR DE TOQUE 12-24V



Ref. 19.05001

12-24
VDC

IP20

PL

NOVO
NUEVO

- _ Sensor funciona sob o sistema touch;
- _ ON/OFF / Dimmer;
- _ Aplicação: Encastre/Superfície.

- _ El sensor funciona mediante el sistema de toque;
- _ ON/OFF/Dimmer;
- _ Aplicación: Empotrar/Superficie.

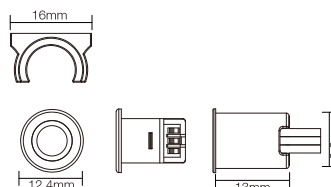

SENSOR DE MOVIMIENTO 12-24V

SENSOR DE MOVIMIENTO 12-24V



Ref. 19.06001

12-24
VDC

IP20

PL

NOVO
NUEVO

- _ Sensor funciona sob o sistema de movimento;
- _ Distância de deteção: 0~3m;
- _ Aplicação: Encastre/Superfície.

- _ El sensor funciona mediante el sistema de movimiento;
- _ Alcance de detección: 0~3m;
- _ Aplicación: Empotrar/Superficie.

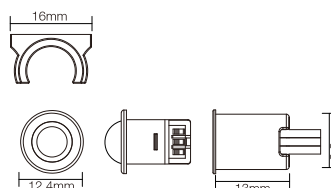

*Os sensores desta página possuem conexão de cabo por mini conector interno.
Los sensores de esta página tienen conexión por cable mediante un mini conector interno.

SISTEMA DE CONTROLO WIRELESS

SISTEMA DE CONTROL INALÁMBRICO

SENSOR DE PORTA E APROXIMAÇÃO

SENSOR DE PUERTA Y APROXIMACIÓN



Ref. 06.04004

12-24
VDC

60W

2,2V
5,5V

6uA

NOVO
NUEVO

Sensor:

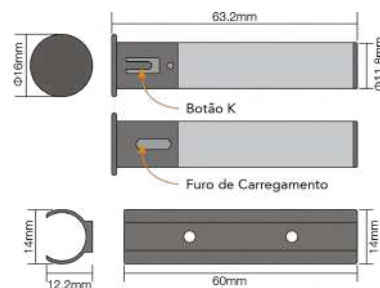

Recetor:

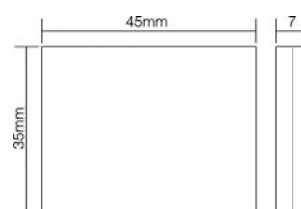

- _ Sensor funciona sob o sistema de porta e aproximação;
- _ WIRELESS / ON/OFF / Dimmer / CCT;
- _ Distância de deteção: 15m (sem barreira);
- _ Aplicação: Encastre/Superfície.

- _ El sensor funciona mediante el sistema de puerta y proximidad;
- _ WIFI/ON/OFF/Dimmer/CCT;
- _ Distancia de detección: 15m (sin barrera);
- _ Aplicación: Empotrar/Superficial.

SENSOR PARA MADEIRA TOUCH

SENSOR TÁCTIL PARA MADERA



Ref. 07.05003

12-24
VDC

60W

IP20

NOVO
NUEVO

- _ Sensor funciona sob o sistema de toque (oculto);
- _ Área de deteção: Painel de madeira com espessura de ≤ 25 mm;
- _ Aplicação: Superfície.

- _ El sensor funciona mediante el sistema táctil (oculto);
- _ Área de detección: panel de madera con un grueso de ≤ 25 mm
- _ Aplicación: Superficial.

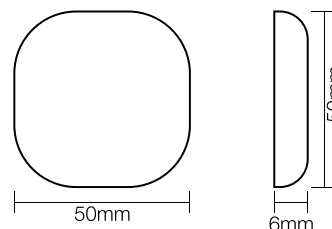

SENSOR DUPLO PARA MADEIRA COM COMUTAÇÃO

SENSOR DOBLE PARA MADERA CON CONMUTACIÓN



Ref. 07.05009

12-24
VDC

60W

IP20

NOVO
NUEVO

- _ Sensor funciona sob o sistema de aproximação (oculto);
- _ Área de deteção: Painel de madeira com espessura de ≤ 25 mm;
- _ Aplicação: Superfície.

- _ El sensor funciona mediante el sistema de aproximación (oculta);
- _ Área de detección: panel de madera con un grueso de ≤ 25 mm
- _ Aplicación: Superficial.

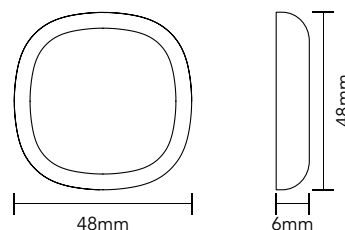



SENSOR DE APROXIMAÇÃO 12-24V

SENSOR DE PROXIMIDAD 12-24V



Cinza
Gris

Ref. 06.04003

12-24
VDC

60W

IP20

PL

NOVO
NUEVO

Sensor conectado por ficha externa.
Sensor conectado mediante conector externo.

- _Sensor funciona sob o sistema de aproximação;
- _Distância de deteção: 8cm;
- _Aplicação: Encastre/Superfície.

- _El sensor funciona mediante el sistema de proximidad;
- _Alcance de detección: 8cm;
- _Aplicación: Empotrar/Superficie.

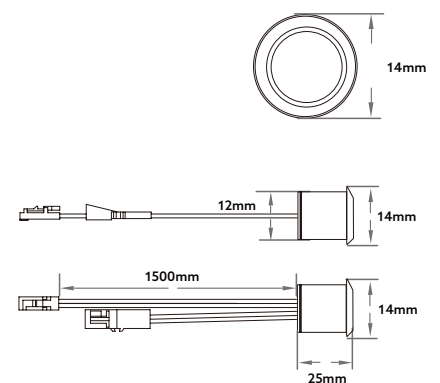

SENSOR DE APROXIMAÇÃO 12-24V

SENSOR DE PROXIMIDAD 12-24V



Castanho
Marrón

Ref. 06.04002

12-24
VDC

60W

IP20

PL

NOVO
NUEVO

Sensor de menor profundidade, sem conector externo. *Sensor de menor profundidad, sin conector externo.*

- _Sensor funciona sob o sistema de aproximação;
- _Distância de deteção: 8cm;
- _Aplicação: Encastre/Superfície.

- _El sensor funciona mediante el sistema de proximidad;
- _Alcance de detección: 8cm;
- _Aplicación: Empotrar/Superficie.

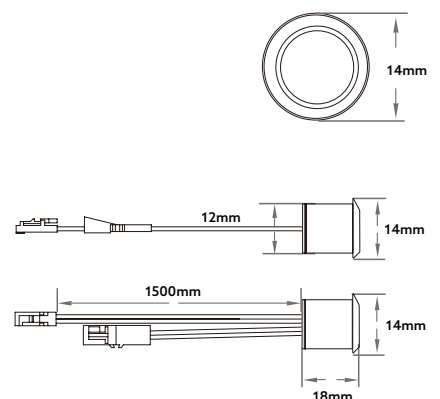

SENSOR DE PORTA 12-24V

SENSOR DE PUERTA 12-24V



Cinza
Gris

Ref. 06.03010

12-24
VDC

60W

IP20

PL

NOVO
NUEVO

Sensor conectado por ficha externa.
Sensor conectado mediante conector externo.

_Sensor funciona sob o sistema de abertura e fecho de porta;

_Distância de deteção: 0-8cm;

_Aplicação: Encastre/Superfície.

_El sensor funciona mediante el sistema de apertura y cierre de la puerta;

_Alcance de detección: 0-8cm;

_Aplicación: Empotrar/Superficie.

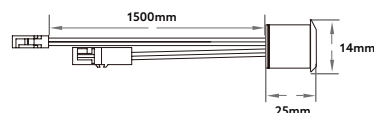
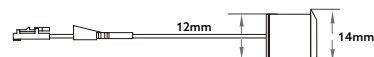
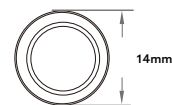

SENSOR DE PORTA 12-24V

SENSOR DE PUERTA 12-24V



Castanho
Marrón

Ref. 06.03008

12-24
VDC

60W

IP20

PL

NOVO
NUEVO

Sensor de menor profundidade, sem conector externo.
Sensor de menor profundidad, sin conector externo.

_Sensor funciona sob o sistema de abertura e fecho de porta;

_Distância de deteção: 0-8cm;

_Aplicação: Encastre/Superfície.

_El sensor funciona mediante el sistema de apertura y cierre de la puerta;

_Alcance de detección: 0-8cm;

_Aplicación: Empotrar/Superficie.

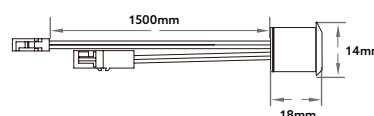
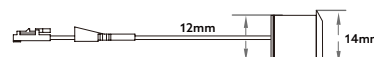

SENSOR DE PORTA DUPLA 12-24V

SENSOR DE PUERTA DOBLE 12-24V



Cinza
Gris

Ref. 06.03011

12-24
VDC

60W

IP20

PL

NOVO
NUEVO

_Sensor funciona sob o sistema de abertura e fecho de porta dupla;

_Distância de deteção: 0-8cm;

_Aplicação: Encastre/Superfície.

_El sensor funciona mediante el sistema de apertura y cierre de la puerta doble;

_Alcance de detección: 0-8cm;

_Aplicación: Empotrar/Superficie.

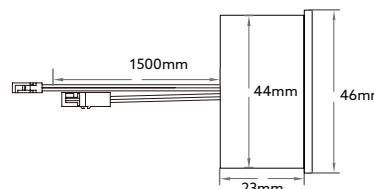
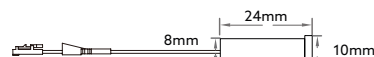

ACESSÓRIOS RECOMENDADOS | ACCESORIOS RECOMENDADOS

Fonte de Alimentação 24Vdc 60W
Fuente de alimentación 24Vdc 60W
Ref. 05.01007



SENSOR DE PORTA DUPLA 12-24V

SENSOR DE PUERTA DOBLE 12-24V



Castanho
Marrón

Ref. 06.03009

12-24
VDC

60W

IP20

PL

NOVO
NUEVO

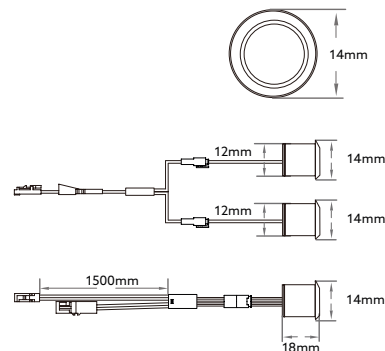

_Sensor funciona sob o sistema de abertura e fecho de porta;

_Distância de deteção: 0-8cm;

_Aplicação: Encastre/Superfície.

_El sensor funciona mediante el sistema de

apertura y cierre de la puerta;

_Alcance de detección: 0-8cm;

_Aplicación: Empotrar/Superficie.

SENSOR TOUCH 12-24V

SENSOR DE TOQUE 12-24V



Cinza
Gris

Ref. 06.05003

12-24
VDC

60W

IP20

PL

NOVO
NUEVO

Sensor conectado por ficha externa.

Sensor conectado mediante conector externo.

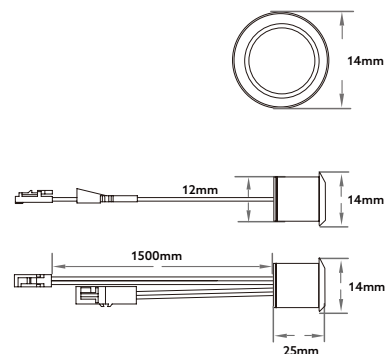

_Sensor funciona sob o sistema touch;

_ON/OFF/Dimmer;

_Aplicação: Encastre/Superfície.

_El sensor funciona mediante el sistema de toque;

_ON/OFF/Dimmer;

_Aplicación: Empotrar/Superficie.

SENSOR TOUCH 12-24V

SENSOR DE TOQUE 12-24V



Castanho
Marrón

Ref. 06.05002

12-24
VDC

60W

IP20

PL

NOVO
NUEVO

Sensor de menor profundidade, sem conector externo.

Sensor de menor profundidad, sin conector externo.

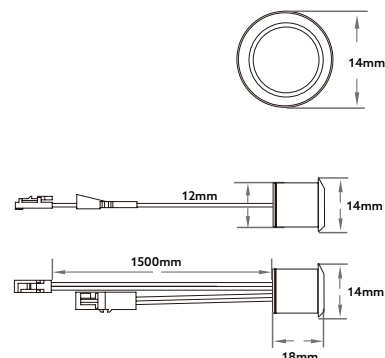

_Sensor funciona sob o sistema touch;

_ON/OFF/Dimmer;

_Aplicação: Encastre/Superfície.

_El sensor funciona mediante el sistema de toque;

_ON/OFF/Dimmer;

_Aplicación: Empotrar/Superficie.

ACESSÓRIOS RECOMENDADOS | ACCESORIOS RECOMENDADOS



Derivador p/ ligar 2 fitas
Derivador p/ conectar 2 tiras
Ref. 08.01003



Extensão de cabo
Prolongador de cable
c/2 pinos | 1800mm
Ref. 09.03001
Ref. 09.03002



Cabo | Cable
(Ideal para acrescento de conexão de sensor
| Ideal para añadir una conexión de sensor)
3 pinos | 1000mm
Ref. 10.03001



Cabo com ligador p/ fita
Cable con conector p/ tira
1000mm
Ref. 09.01002



Cabo para soldar à fita
Cable para soldar a la cinta
1500mm
Ref. 09.01001



SENSOR DE MOVIMENTO 12-24V

SENSOR DE MOVIMIENTO 12-24V



Ref. 06.06005

12-24
VDC

60W

IP20

PL

NOVO
NUEVO

Sensor conectado por ficha externa.
Sensor conectado mediante conector externo.

- _Sensor funciona sob o sistema de movimento;
- _Distância de deteção: 0~3m;
- _Aplicação: Encastre/Superfície.

- _El sensor funciona mediante el sistema de movimiento;
- _Alcance de detección: 0~3m;
- _Aplicación: Empotrar/Superficie.

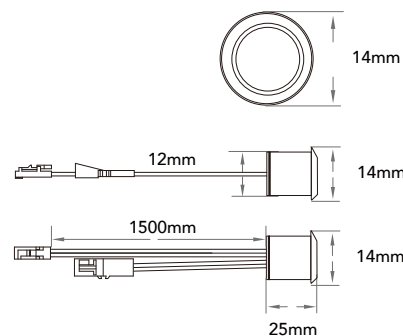

SENSOR DE MOVIMENTO 12-24V

SENSOR DE MOVIMIENTO 12-24V



Ref. 06.06004

12-24
VDC

60W

IP20

PL

NOVO
NUEVO

- _El sensor funciona mediante el sistema de apertura y cierre de la puerta;
- _Alcance de detección: 0-3cm;
- _Aplicación: Empotrar/Superficie.

- _Sensor funciona sob o sistema de abertura e fecho de porta;
- _Distância de deteção: 0-3cm;
- _Aplicação: Encastre/Superfície.

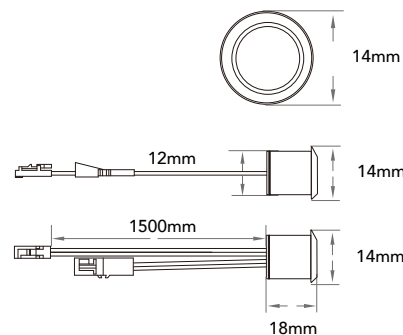

ACESSÓRIOS RECOMENDADOS | ACCESORIOS RECOMENDADOS



Derivador p/ ligar 2 fitas
Derivador p/ conectar 2 tiras
Ref. 08.01003



Extensão de cabo
Prolongador de cable
c/2 pinos | 1800mm
Ref. 09.03001
Ref. 09.03002



Cabo | Cable
(Ideal para acrescento de conexão de sensor
| Ideal para añadir una conexión de sensor)
3 pinos | 1000mm
Ref. 10.03001



Cabo com ligador p/ fita
Cable con conector p/ tira
1000mm
Ref. 09.01002



Cabo para soldar à fita
Cable para soldar a la cinta
1500mm
Ref. 09.01001

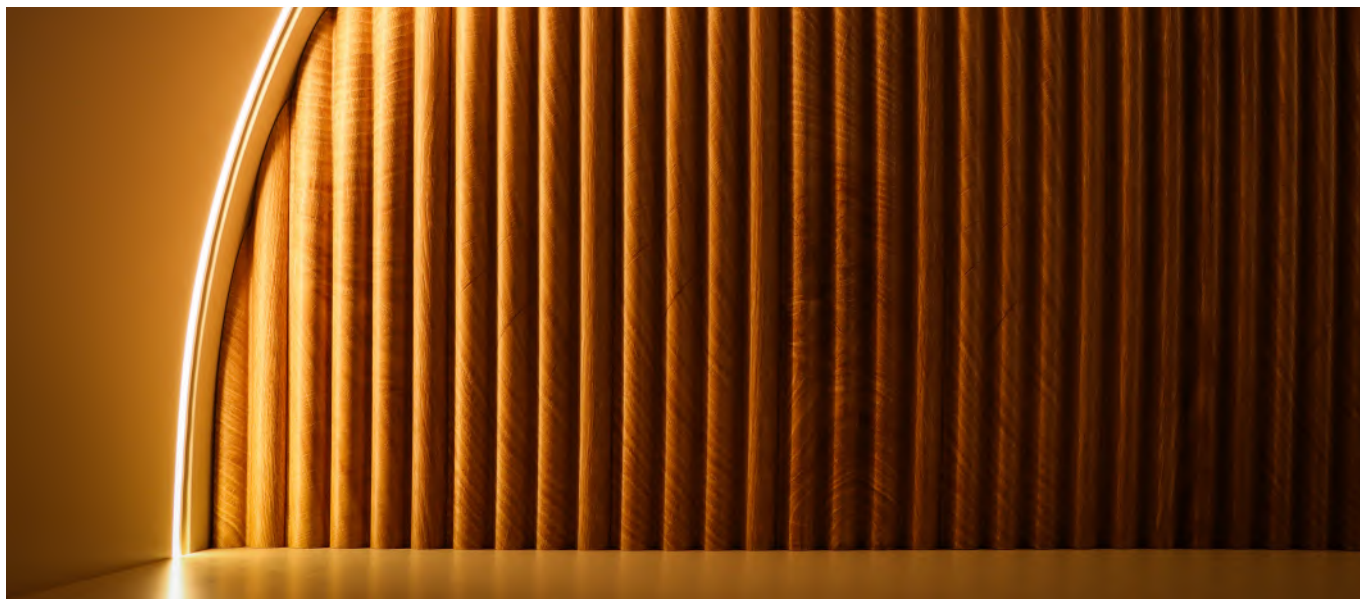

FONTES DE ALIMENTAÇÃO | GAMA STANDARD
FUENTES DE ALIMENTACIÓN



Ref.	Tensão de Entrada Tensión de Entrada	Tensão de Saída Tensión de Salida	Corrente Corriente	Canais Canales	Potência Potencia	Dimensão
05.01101	200-240Vac	12/24Vdc	3A / 1.5A	12CH	36W	136x50x18mm
05.01102	200-240Vac	12/24Vdc	5A / 2.5A	12CH	60W	166x50x18mm
05.01103	200-240Vac	12/24Vdc	8.3A / 4.17A	12CH	100W	196x50x18mm
05.01104	200-240Vac	12/24Vdc	12.5A / 6.25A	12CH	150W	226x50x18mm
05.01105	200-240Vac	12/24Vdc	16.67A / 8.3A	12CH	200W	246x50x18mm

*Estas fontes têm saída de born de 2,5mm e tensão selecionável por Switch.
Estas fuentes tienen una salida de borne de 2,5 mm y tensión seleccionable por interruptor.

FONTES DE ALIMENTAÇÃO | GAMA PRO
FUENTES DE ALIMENTACIÓN



Ref.	Tensão de Entrada Tensión de Entrada	Tensão de Saída Tensión de Salida	Corrente Corriente	Canais Canales	Potência Potencia	Dimensão
05.01005	220-240Vac	24Vdc	2,5A	6CH	24W	130x78x19mm
05.01006	220-240Vac	24Vdc	3,5mA	6CH	36W	130x78x19mm
05.01007	220-240Vac	24Vdc	5A	8CH	60W	170x78x19mm
05.01008	220-240Vac	24Vdc	7A	8CH	100W	237x78x19mm

INTERRUPTOR DIMMER TÁTIL/APROXIMAÇÃO

INTERRUPTOR TÁCTIL/DE PROXIMIDAD CON REGULADOR DE INTENSIDAD

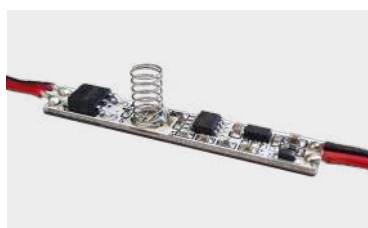

Ref. 2114518.448

12-24 VDC 4,0A COM LUZ

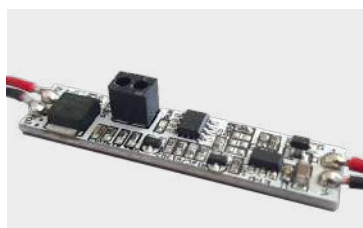

Ref. 2114518.496

12-24 VDC 4,0A DIMÁVEL

A luz acende pelo toque na superfície do interruptor de plástico ou acrílico. O amortecimento pode chegar a 5 mm. La luz se enciende al tocar la superficie del interruptor de plástico o acrílico. La amortiguación puede alcanzar los 5 mm.

É ativado e desativado por infravermelhos, passando a mão na frente do sensor. Mantendo a mão por cima do sensor (sem tocar), este irá dimar. Se activa y desactiva por infrarrojos, pasando la mano por delante. Manteniendo la mano sobre el sensor (sin tocarlo), se atenuará.

SENSOR DE MOVIMENTO P/ PERFIL

SENSOR DE MOVIMIENTO P/ PERFIL



Ref. 2114518.1460

12-24 VDC 3,0A NOVO NUEVO



Este sensor funciona por meio de infravermelhos de baixa voltagem. Usa sensor piroelétrico para detetar movimento humano. Em caso de instalação de mais do que 1un, estes sensores não poderão estar no mesmo raio de alcance. Este sensor funciona mediante infrarrojos de bajo voltaje. Utiliza un sensor piroeléctrico para detectar el movimiento humano. En caso de instalación de más de 1 unidad, estos sensores no pueden estar en el mismo rango.

SENSOR DE PORTA C/ DIMMER

SENSOR DE PUERTA CON REGULADOR DE INTENSIDAD



Ref. 2114269.5196

IP20 12-48 VDC 96W 12V 192W 24V 8A

Quando a porta abre, o sensor deteta a ausência do objeto e a luz acende.

Quando la puerta se abre, el sensor detecta la ausencia del objeto y la luz se enciende.

SENSOR DE MOVIMENTO P/ PERFIL COM TEMPORIZADOR

SENSOR DE MOVIMIENTO PARA PERFIL CON TEMPORIZADOR

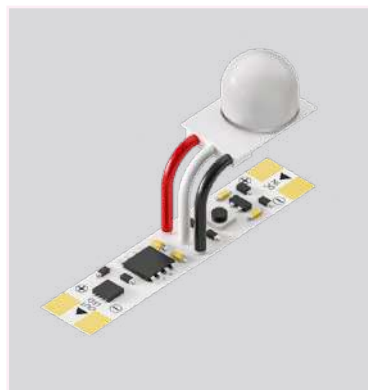

Ref. 2139518.10120

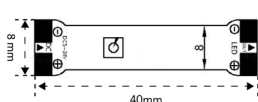

Ref. 2140518.10120

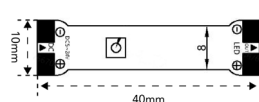

IP20 5-24V DC 5A NOVO NUEVO

Sensor de Movimento, com fio do sensor de 50mm. Distância máxima de sensibilidade: 2mt. Opção de tempo de espera: 15, 30 e 60s; 2, 5, 10, 30, 60min.

Sensor de movimiento, con cable sensor de 50 mm. Distancia máxima de sensibilidad: 2mt. Opciones de tiempo de espera: 15, 30 y 60s; 2, 5, 10, 30 y 60 min.

Sensores de características iguais, a diferença entre os 2 modelos é meramente a medida.

Estes sensores podem ser usados com os conectores: ref.: 227211.19 (8mm) e ref.: 227212.19 (10mm).

Sensores con características idénticas, la diferencia entre los dos modelos es meramente la medida.

Estos sensores se pueden utilizar con los conectores: ref.: 227211.19 (8 mm) y ref.: 227212.19 (10 mm).

SENSOR INFRA-VERMELHOS P/ ESCADAS

SENSOR INFRARROJOS P/ESCALERAS



Ref. 2229262.114

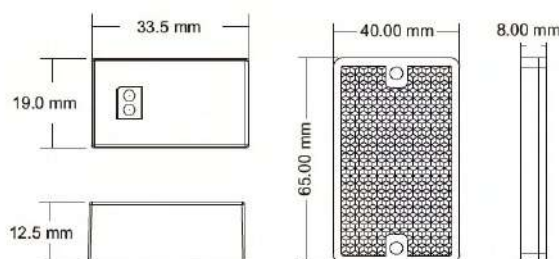

Sensor de infra-vermelhos acionado com a passagem de movimento do utilizador. Para uso com o controlador de escada (ref. 2114244.4768). Distância máxima de deteção: 1,4mt

Sensor de infrarrojos activado con el movimiento del usuario. Para utilizar con el controlador de escalera (ref. 2114244.4768). Distancia máxima de detección: 1,4mt.

SENSOR REDONDO ENCASTRAR

SENSOR REDONDO EMPOTRADO



Ref. 2226262.PORTA

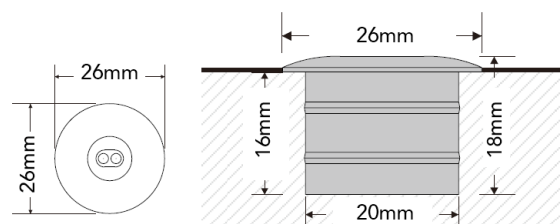

Quando a porta abre, o sensor deteta a ausência do objeto e a luz acende.

Cuando se abre la puerta, el sensor detecta la ausencia del objeto y se enciende la luz.

SENSORES / INTERRUPTORES PARA PORTAS

CONTROLADOR

Ref. 2127268.4120



Sensor de Movimento
Sensor de Movimiento
Ref. 2127264.MOVE

Sensor de Toque
Sensor táctil
2127264.TOUCH

Sensor de Gavetas
Sensor de Cajones
Ref. 2127265.PORTA

Sensor de Porta
Sensor de Puerta
2127264.PORTA



SENSOR REDONDO ENCASTRAR C/ CABO + FICHA

SENSOR REDONDO EMPOTRABLE CON CABLE + FICHA

Ref. 2226262.IR



_Quando a porta se abre, ou não havendo obstáculos à frente, a luz acende-se gradualmente. Apagando-se de igual forma, quando a porta se fecha ou deixe de existir obstáculo;

_Distância de deteção: <10cm;

_Ângulo de deteção: 15-30°.

_Cuando la puerta se abre, o no hay obstáculos adelante, la luz se enciende gradualmente. Apagando de la misma manera, cuando la puerta se cierra o ya no hay obstáculo;

_Distancia de detección: <10 cm;

_Ángulo de detección: 15-30°.

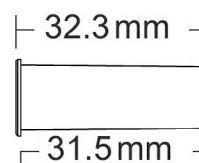

SENSOR TOUCH MADEIRA C/ CABO + FICHA

SENSOR TÁCTIL DE MADERA CON CABLE + FICHA

Ref. 2227262.MAD



_O meio pode ser madeira, vidro ou plástico;

_Distância de deteção: < 5cm.

_El soporte puede ser madera, vidrio o plástico;

_Distancia de detección: <5cm.

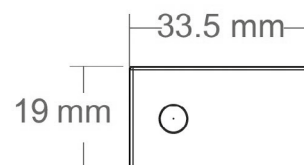

SENSOR MOVIMENTO SALIENTE C/ CABO + FICHA

SENSOR DE MOVIMIENTO SALIENTE CON CABLE + FICHA

Ref. 2227262.MOV



_Quando existe movimento na área de deteção, a luz acende; quando deixa de haver movimento nesta área, a luz apaga-se após 30 segundos;

_Área de deteção: 3mt;

_Ângulo de deteção: 120°.

_Cuando hay movimiento en el área de detección, la luz se enciende; cuando no haya más movimiento en esta área, la luz se apagará después de 30 segundos;

_Área de detección: 3mt;

_Ángulo de detección: 120°.

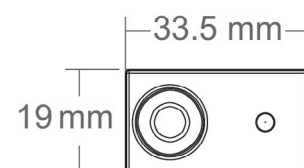

NOTA:

Sensores compatíveis com o sensor de presença/movimento c/ dimmer Ref. 2114269.5196.

Sensores compatíveis com o sensor de presença/movimento c/ dimmer Ref. 2114269.5196.

FONTE DE ALIMENTAÇÃO SLIM C/ FICHAS DE LIGAÇÃO 60W IP20
FUENTE DE ALIMENTACIÓN SLIM C/ FICHAS DE CONEXIÓN



	60W	100 240 VAC	1 CANAL	5A CANAL	
	M M	CE	12V DC		

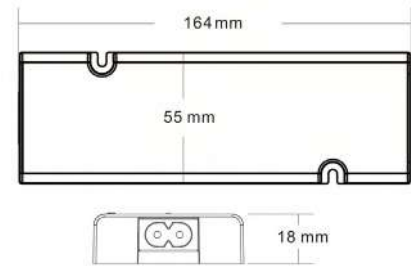

DERIVADOR DIMMER RF + SENSOR 6 SAÍDAS 60W
DERIVADOR REGULABLE RF + SENSOR 6 SALIDAS



12V DC	6 CANAIS	RF	CE
-------------------	---------------------	-----------	-----------

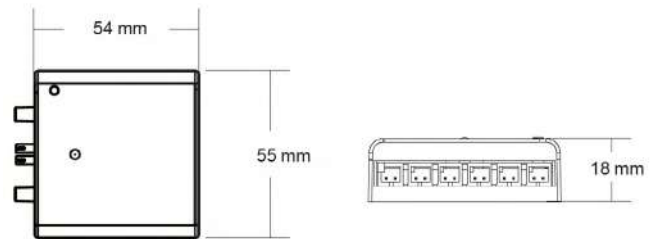

FONTE DE ALIMENTAÇÃO SLIM
FUENTE DE ALIMENTACIÓN SLIM

Ref. 201881.160

_Topo sensor
 2227262.MOV | 2227262.MAD | 2226262.IR

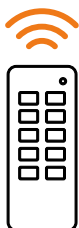
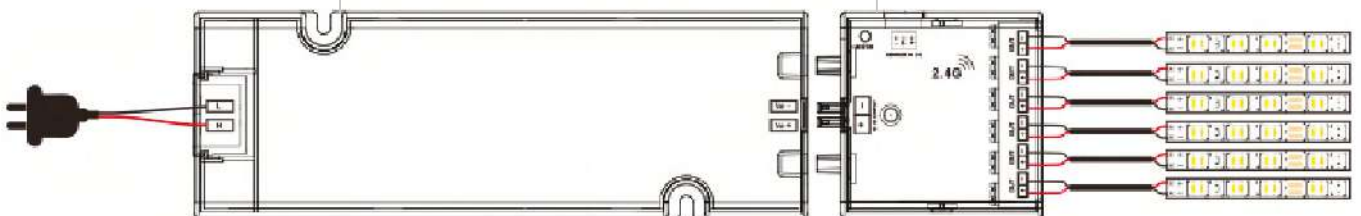

_Funciona com todos os comandos da serie ECO
 2120244.DIM | 2120244.DIM4 | 2121244.DIM

_Funciona con todos los controles de la serie ECO
 2120244.DIM | 2120244.DIM4 | 2121244.DIM

DERIVADOR DIMMER RF + SENSOR
DERIVADOR REGULABLE RF + SENSOR

Ref. 2225219.196





FITA LED NEON

Tira Led Neón

COSTUMIZAÇÃO DE NEONS

PERSONALIZACIÓN DE NEONES

Disponemos de um serviço único de corte e vulcanização, com tecnologia inovadora no mercado que permite a customização das medidas do neon de acordo com a necessidade de cada cliente, garantindo o IP e a dimensão ao longo de todo o comprimento, incluindo nas extremidades.

Disponemos de un servicio de corte y vulcanizado único, con tecnología innovadora en el mercado que permite personalizar las medidas de neón según las necesidades de cada cliente, garantizando el IP y dimensión en todo el largo, incluidos los extremos.

1



Corte à medida
Cortado a la medida

2

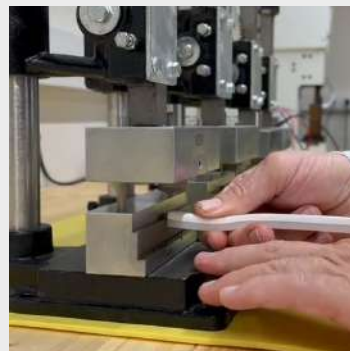

Preparação para soldagem de cabo
Preparación para soldar cables

3

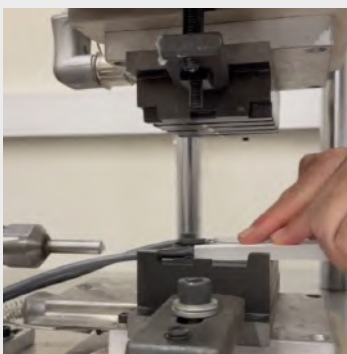

Aplicação de silicone
Aplicación de silicona

4



Finalização do topo
Acabado superior

NOTA:

Consulte as condições para customizações de medidas não standardizadas.

Consulta las condiciones para personalización de medidas no estándar.

COSTUMIZAÇÃO DE ACABAMENTOS E CONEXÕES

PERSONALIZACIÓN DE ACABADOS Y CONEXIONES

Acabamento MOTAKO
Acabado MOTAKO

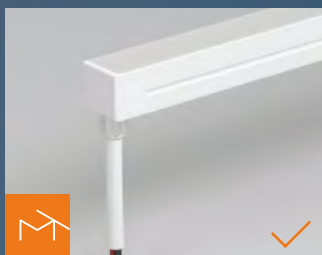

Acabamento normalizado
Acabado estándar



Personalização do cabo:

- _Tipo de saída
- _Comprimento do cabo
- _Tipo de cabo

Personalización de cables:

- _Tipo de salida
- _Longitud del cable
- _Tipo de cable

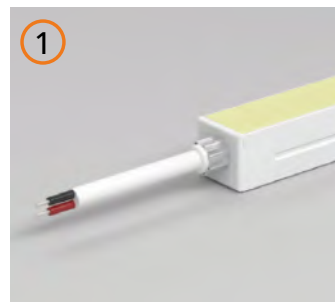

Cabo com saída de topo
Cable con salida superior



Cabo com saída por baixo
Cable con salida inferior

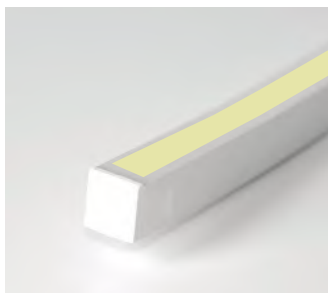

**Ponta tamponada
sem cabo**
Punta tamponada
sin cable

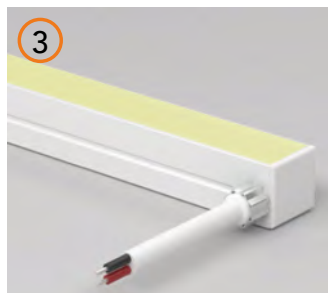

**Cabo com saída lateral
direita**
Cable con salida lateral
derecha

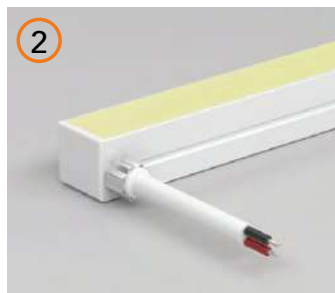

**Cabo com saída lateral
esquerda**
Cable con salida lateral
izquierda

Na produção de néons, a faturação é feita ao metro e não ao rolo. A medida de corte deverá ser adequada à unidade de corte de cada néon. É necessário confirmar quais os néons possíveis de customização.

En la producción de neón, la facturación se realiza por metros y no por rollo. El tamaño de corte debe adaptarse a la unidad de corte de cada neón. Es necesario confirmar qué neones se pueden personalizar.

INSTRUÇÕES DE MONTAGEM

INSTRUCCIONES DE MONTAJE

Para uma boa utilização dos neons Motako recomendam-se as instruções de montagem:

Para un buen uso de las luces de neón Motako se recomiendan las siguientes instrucciones de montaje:

PRECAUÇÕES DE INSTALAÇÃO PRECAUCIONES DE INSTALACIÓN

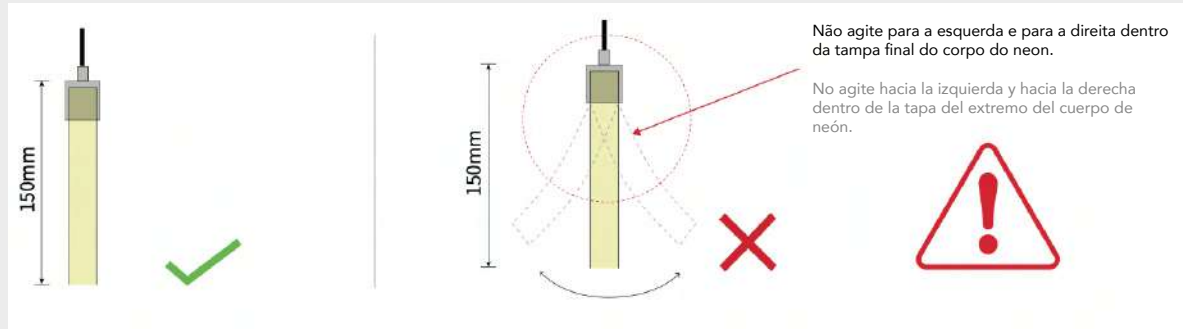

APLIQUE O NEON NO PERFIL APLICAR NEÓN AL PERFIL

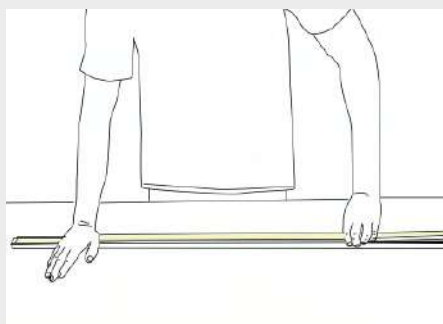

Pressione o neon de com a palma da mão para inseri-lo lentamente na ranhura e endireite-o suavemente acima da ranhura com a mão direita. Tente manter o neon plano durante o processo de instalação.

Presione el neón con la palma para insertarlo lentamente en la ranura y enderece suavemente el neón sobre la ranura con la mano derecha. Intente mantener el neón plano durante el proceso de instalación.

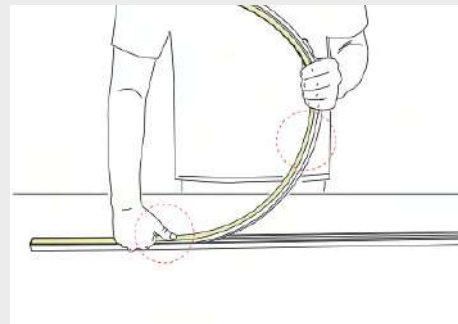

Não pressione o neon com um único dedo, pois é fácil danificar as suas partes internas. O arco dobrado do neon não deve ser demasiado grande durante a instalação.

No presiones el neón con un solo dedo, ya que es fácil dañar sus partes internas. El arco de neón doblado no debe ser demasiado grande durante la instalación.

NEONS SIDE

Precauções de instalação (se o comprimento da luz for superior a 2 metros, duas pessoas devem trabalhar em conjunto para instalar.)

Precauciones de instalación (si la longitud de la luz es superior a 2 metros, dos personas deben trabajar juntas para instalarla).

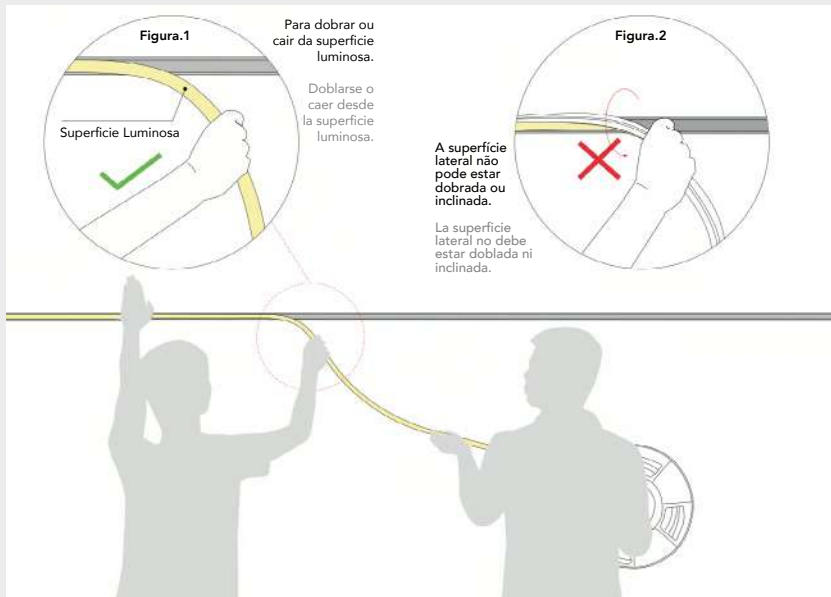

2.ASSISTENTE:

Coopere com o instalador para levantar o rolo do neon e, em seguida, entregue lentamente o neon ao instalador. Não puxe ou torça a luz durante a instalação.

Coopere con el instalador para levantar el rollo de neón y luego entregue lentamente el neón al instalador.No tire ni gire la luz durante la instalación.

1.INSTALADOR:

Pressione o neon com a palma da mão esquerda para carregá-lo lentamente na ranhura. Endireite o neon com a mão direita para que ele caia na direção da sua mão.

Veja a figura 1.

A superfície lateral não pode estar dobrada ou inclinada. Veja a figura 2

Presiona el neón con la palma izquierda para cargarlo lentamente en la ranura. Endereza el neón con tu mano derecha para que caiga hacia tu mano. Ver figura 1.

La superficie lateral no debe estar doblada ni inclinada. Ver figura 2

NEONS UP

Precauções de instalação (se o comprimento da luz for superior a 2 metros, duas pessoas devem trabalhar em conjunto para instalar.)

Precauciones de instalación (si la longitud de la luz es superior a 2 metros, dos personas deben trabajar juntas para instalarla).

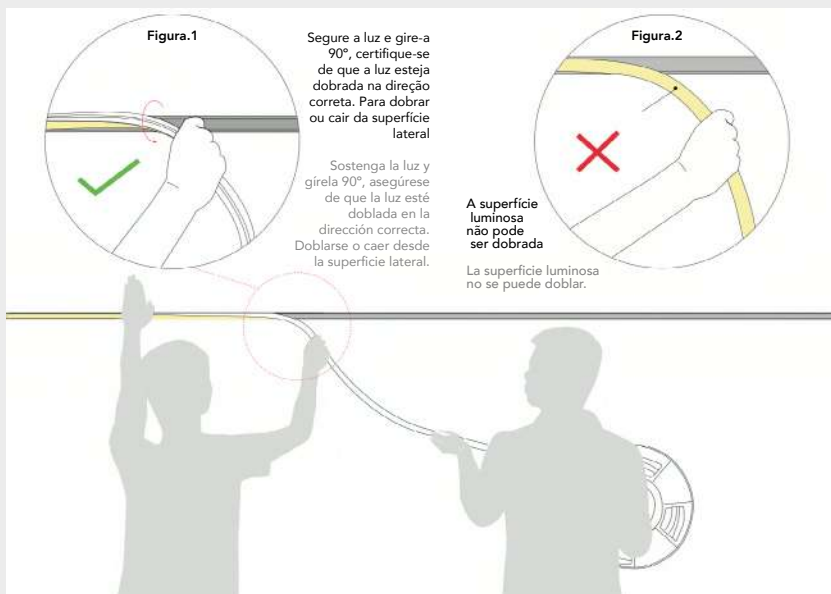

2.ASSISTENTE:

Coopere com o instalador para levantar o rolo do neon e, em seguida, entregue lentamente o neon ao instalador. Não puxe ou torça a luz durante a instalação.

Coopere con el instalador para levantar el rodillo de luz y luego entregue lentamente la luz al instalador. No tire ni gire la luz durante la instalación.

1.INSTALADOR:

Pressione o neon com a palma da mão esquerda para carregá-lo lentamente na ranhura. Endireite o neon com a mão direita, segure-o e gire-o 90° na direção da sua mão para deixá-lo cair. Veja a figura 1.

A superfície lateral não pode estar dobrada. Veja a figura 2

Presiona el neón con la palma izquierda para cargarlo lentamente en la ranura. Endereza el neón con tu mano derecha, sostenlo y gíralo 90° hacia tu mano para dejarlo caer. Ver figura 1.





SKOLL LUZ 360°

Fita Led Neon / Tira Led Neón

NEON 360° SKOLL 10W IP65



FITA LED NEON



Modelo	Ref.	Cor Color	Tensão Tensión	IP	Lumens /mt	Lumens /w
SKOLL 3 Steps MacAdam	1391275.1027	2700K	24V	IP65	517Lm	51.7Lm
	1391275.1030	3000K	24V	IP65	529Lm	52.9Lm
	1391275.1040	4000K	24V	IP65	556Lm	55.6Lm
	1391275.10RGB	RGB	24V	IP65	248Lm	24.8Lm
	1391275.16RGBWW	RGB + 3000k	24V	IP65	510Lm	51,0Lm

Este modelo standard tem saída de cabo de topo. | Este modelo estándar tiene una salida de cable superior.



Disponível com os seguintes acabamentos: | Disponible con los siguientes acabados:



Neon 360° Soft
Neón 360° Soft



Neon 360° Corda
Neón 360° Cuerda

Disponível também em CCT+W
También disponible en CCT+W

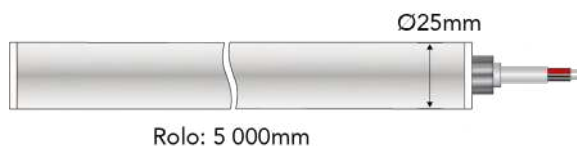

ACESSÓRIOS RECOMENDADOS | ACCESORIOS RECOMENDADOS

<p>Kit suspensão c/ alimentação 1mt Ref. 2223157</p> 	<p>Calha fixadora 1mt Ref. PF169PL</p> 	<p>Kit fixador c/topo Ref. 2220457</p> 	<p>Fixador 360° Ref. 2226657</p> 	<p>Ligador p/neon 360° Ref. 2220257.2</p> 
--	--	--	---	---

NEON 360° SKOLL RIGIDA 20W IP65

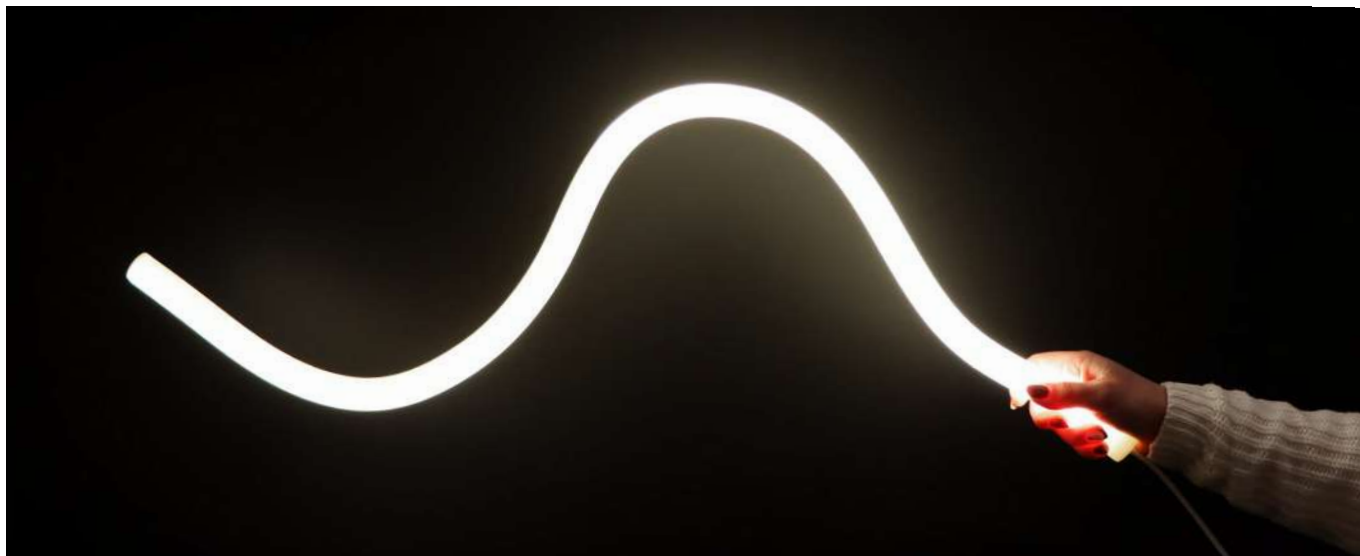

20W/m
24V DC
IP65
CRI >90
5m
CONEXÃO MÁXIMA 5m
RESISTÊNCIA UV
M M
CE
NOVO NUEVO

Este modelo standard tem saída de cabo de topo. Este modelo estándar tiene una salida de cable superior.

Modelo	Ref.	Cor Color	Tensão Tensión	IP	Lumens /mt	Lumens /w
SKOLL RIGIDA	1391275.2027	2700K	24V	IP65	1100Lm	55Lm
	1391275.2030	3000K	24V	IP65	1180Lm	59Lm

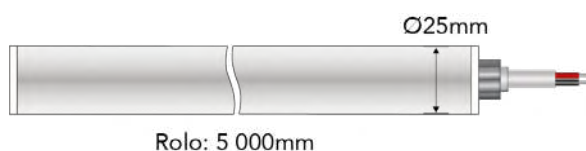

ACESSÓRIOS RECOMENDADOS | ACCESORIOS RECOMENDADOS

<p>Kit suspensão c/ alimentação 1mt Ref. 2223157</p> 	<p>Calha fixadora 1mt Ref. PF169PL</p> 	<p>Kit fixador c/topo Ref. 2220457</p> 	<p>Fixador 360° Ref. 2226657</p> 	<p>Ligador p/neon 360° Ref. 2220257.2</p> 
--	--	--	---	---





**NEON
UP + SIDE**

Neón Up + Side

NEON UP+SIDE RUBI 6W IP67



FITA LED NEON



Modelo	Ref.	Cor Color	Tensão Tensión	IP	Lumens /mt	Lumens /w
RUBI 50000H	13281016.0627	2700K	24V	IP67	279Lm	46,5Lm
	13281016.0630	3000K	24V	IP67	281Lm	46,9Lm
	13281016.0640	4000K	24V	IP67	281Lm	46,8Lm

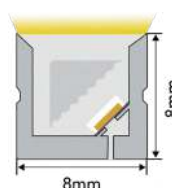
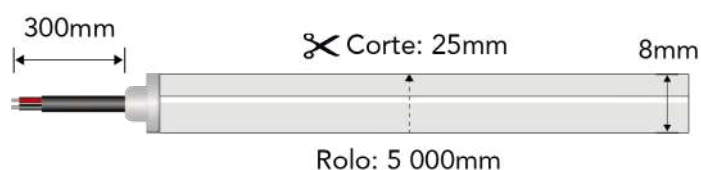
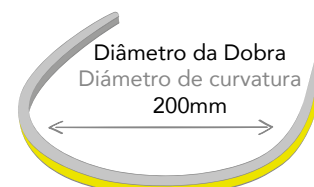

Este modelo standard tem saída de cabo de topo.
Este modelo estándar tiene una salida de cable superior.



ACESSÓRIOS RECOMENDADOS | ACCESORIOS RECOMENDADOS

Calha Fixadora AL
1mt
Perfil de Fijación AL
1mt
Ref. PF1143AL

Calha Flexível Inox 1mt
Perfil flexible Inox 1mt
Ref. PF18143IX

Tampa final
Silicone
Tapa final Silicona
Ref. 2219782

Ligador com cabo
Ligador con cable
Ref. 2220782

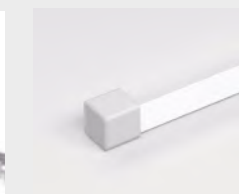

NEON UP+SIDE ANTEIA 10W IP67



Esta fita permite a sua torção nos dois sentidos, sendo uma fita **UP + SIDE**.

Esta tira permite su torsión en ambos sentidos, siendo una tira **UP + SIDE**.



Modelo	Ref.	Cor Color	Tensão Tensión	IP	Lumens /mt	Lumens /w
ANTEIA	1328116.1027	2700K	24V	IP67	464Lm	46Lm
L70B10 54000H	1328116.1030	3000K	24V	IP67	486Lm	49Lm
2 Steps MacAdam	1328116.1040	4000K	24V	IP67	506Lm	51Lm
	1328116.1065	6500K	24V	IP67	493Lm	49Lm

Este modelo standard tem saída de cabo de topo.
Este modelo estándar tiene una salida de cable superior.

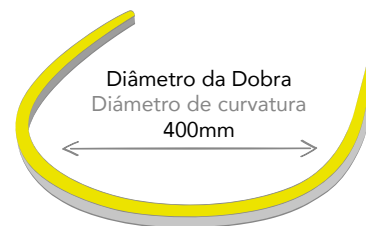
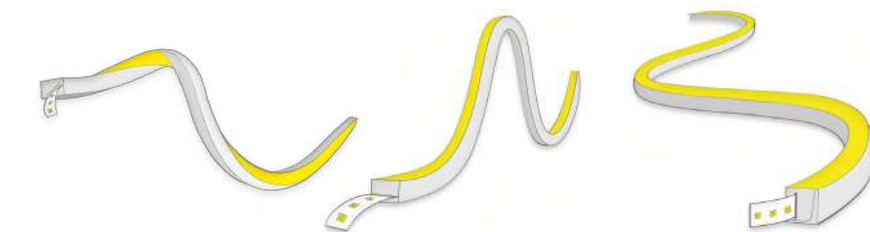
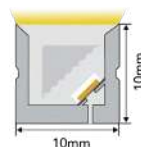
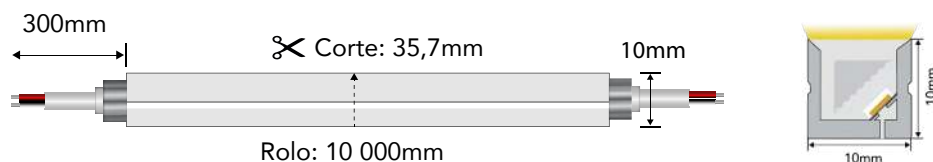
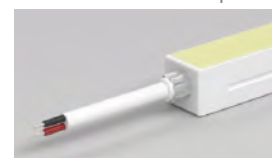

ACESSÓRIOS RECOMENDADOS | ACCESORIOS RECOMENDADOS

<p>Tampa final Tapa final Ref. 2219243</p> 	<p>Conector Ref. 2220243</p> 	<p>Calha fixadora PL 1mt Perfil de fijación PL 1mt Ref. PF148PL</p> 	<p>Calha fixadora AL 1mt Perfil de fijación AL 1mt Ref. PF148AL</p> 	<p>Fixador 1010 Fijador 1010 Ref. 2226143</p> 
--	--	---	--	---

NEON UP+SIDE NEREIDA 10W IP67



Esta fita permite a sua torção nos dois sentidos, sendo uma fita **UP + SIDE**.

Esta tira permite su torsión en ambos sentidos, siendo una tira **UP + SIDE**.

FITA LED NEON



Modelo	Ref.	Cor Color	Tensão Tensión	IP	Lumens /mt	Lumens /w
NEREIDA	1321286.1027	2700K	24V	IP67	692Lm	69Lm
L70B10 54000H	1321286.1030	3000K	24V	IP67	703Lm	70Lm
2 Steps MacAdam	1321286.1040	4000K	24V	IP67	720Lm	72Lm
	1321286.1050	5000K	24V	IP67	736Lm	74Lm

Este modelo standard tem saída de cabo por baixo.
Este modelo estándar tiene una salida de cable inferior.

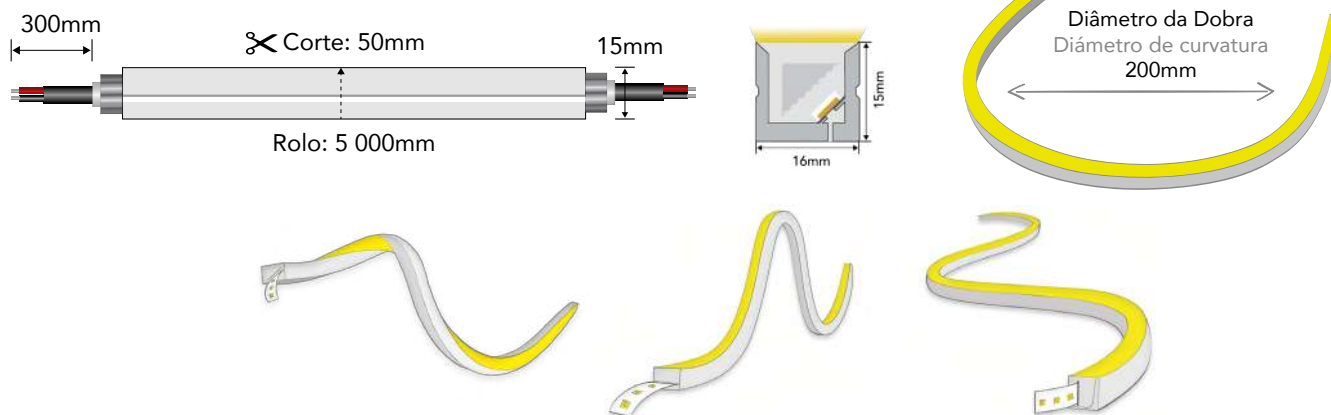

ACESSÓRIOS RECOMENDADOS | ACCESORIOS RECOMENDADOS

<p>Tampa final Tapa final Ref. 2219253</p>	<p>Conector Ref. 2220654</p>	<p>Calha fixadora PL 1mt Perfil de fijación PL 1mt Ref. PF152PL</p>	<p>Calha fixadora AL 1mt Perfil de fijación AL 1mt Ref. PF152AL</p>	<p>Fixador 1615 Fijador 1615 Ref. 2226144</p>
--	----------------------------------	---	---	---

NEON LUZ BILATERAL NOVA SINOPE 10W IP67



Modelo	Ref.	Cor Color	Tensão Tensión	IP	Lumens /mt	Lumens /w
NOVA SINOPE 54000H	13461116.1027	2700K	24V	IP67	604Lm	60Lm
	13461116.1030	3000K	24V	IP67	617Lm	62Lm
	13461116.1040	4000K	24V	IP67	638Lm	64Lm

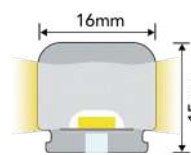
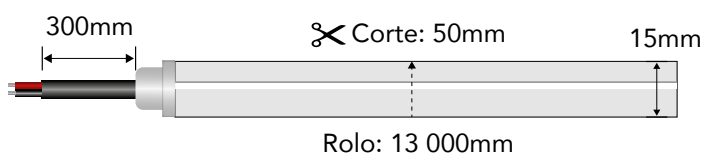
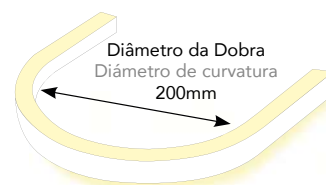

Este modelo standard tem saída de cabo de topo.
Este modelo estándar tiene una salida de cable superior.

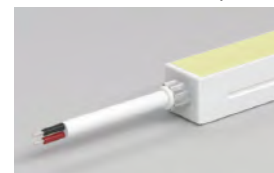

ACESSÓRIOS RECOMENDADOS | ACCESORIOS RECOMENDADOS

Calha Fixadora AL 1mt
Perfil de Fijación AL 1mt
Ref. PF11411

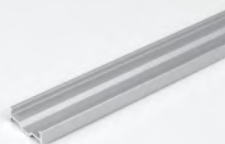

Personalização de cabo só é feita sob encomenda à fábrica.*
La personalización del cable solo se realiza mediante pedido de fábrica.*

*Sujeito a confirmação de prazo de entrega.
Sujeto a confirmación del tiempo de entrega.

NEON UP+ SIDE WALL WASHER 24W IP65



FITA LED NEON



Modelo	Ref.	Cor Color	Tensão Tensión	IP	Lumens /mt	Lumens /w
WALLWASHER 30000H	138.242	2700K	24V	IP65	1525Lm	64Lm
	138.243	3000K	24V	IP65	1580Lm	66Lm
	138.244	4000K	24V	IP65	1545Lm	64Lm
	138.246	6500K	24V	IP65	1480Lm	62Lm

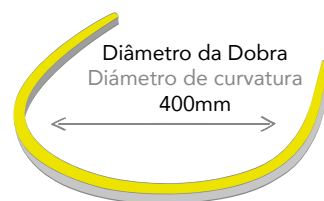

Este modelo standard tem saída de cabo de topo. Este modelo estándar tiene una salida de cable superior.

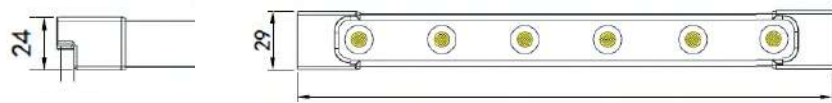

Rolo: 5000mm | Corte: 41,5mm

Ângulos disponíveis por encomenda



Tem o ângulo de luz mais fechado do que uma fita de led, pelo que possibilita um foco de luz mais forte. Ideal para projetar luz numa parede e fazer um varrimento em altura.

Tiene un ángulo de luz más estrecho que una tira de LED, por lo que permite un foco de luz más fuerte. Ideal para proyectar luz sobre una pared y barrer en altura.

COMPOSIÇÃO DA REFERÊNCIA:

138.	242.	82.	3500.	03
Familia	Potência	Cor	Ângulo	Medida Troço
			Direção Cabo	

SUGESTÕES | SUGERENCIAS

Fixador Fijador Ref. 2223462



Calha fixação AL 1mt Perfil de fijación AL 1mt Ref. PF172AL



Fita sob encomenda. Tira por encargo.

CARACTERÍSTICAS DE PERSONALIZAÇÃO

- A. Ângulo. Ángulo.
- B. Direção do cabo. Dirección del cable.
- C. Comprimento do rolo. Longitud del rolo.

Medida de rolo disponível até 5mt. Tamaño de rolo disponible un máximo de 5 metros.

WALL WASHER POWER FLEXÍVEL 48W IP67

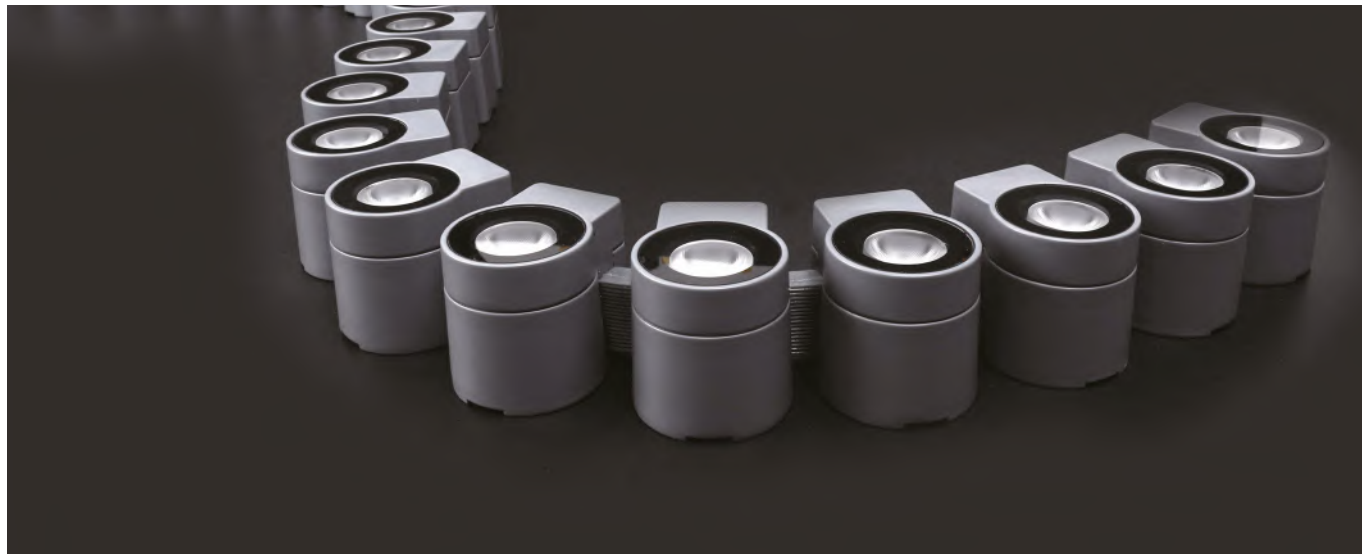

Modelo	Ref.	Cor Color	Tensão Tensión	IP	Lumens /mt	Lumens /w
WALLWASHER POWER	137.482	2700K	24V	IP67	2787Lm	58Lm
	137.483	3000K	24V	IP67	3165Lm	66Lm
	137.484	4000K	24V	IP67	3339Lm	70Lm
	137.486	6500K	24V	IP67	3442Lm	72Lm

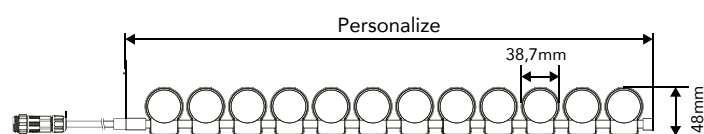
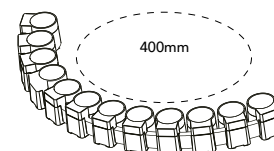
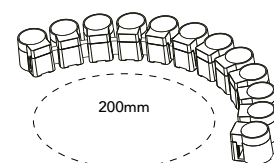

Este modelo tem as seguintes saídas de cabo:
Este modelo tiene las siguientes salidas de cable:



Ângulos disponíveis por encomenda
Ángulos disponibles bajo pedido

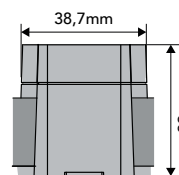

COMPOSIÇÃO DA REFERÊNCIA:

137.485.82.3500.03

Família: 137
 Potência: 485
 Cor: 82
 Direção Cabo: 35
 Medida Cabo: 00
 Medida Neon: 03
 Ângulo: 03

ACESSÓRIOS RECOMENDADOS | ACCESORIOS RECOMENDADOS

Clip de Fixação
Clip de Fijación
Ref. 2241485



Clip Fixação Ajustável
Clip fijación Ajustable
Ref. 2242485



Proteção de Lente
Protección de la Lente
Ref. 2243485



Fita sob encomenda. Tira por encargo.

CARACTERÍSTICAS DE PERSONALIZAÇÃO
FUNCIONES DE PERSONALIZACIÓN

- A. Ângulo. Ángulo.
- B. Direção do cabo. Dirección del cable.
- C. Comprimento do rolo. Longitud del rolo.

Medida de rolo disponível até 5mt.
Tamaño de rolo disponible un máximo de 5 metros.





NEON UP

Neón Up

NEON UP JANO 6W IP67



FITA LED NEON



Modelo	Ref.	Cor Color	Tensão Tensión	IP	Lumens /mt	Lumens /w
JANO	1394136.0627	2700K	24V	IP67	340Lm	57Lm
L70B80 5000H	1394136.0630	3000K	24V	IP67	332Lm	55Lm
3 Steps MacAdam	1394136.0640	4000K	24V	IP67	372Lm	62Lm

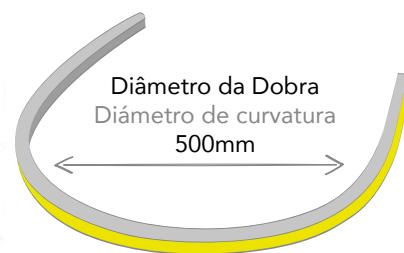
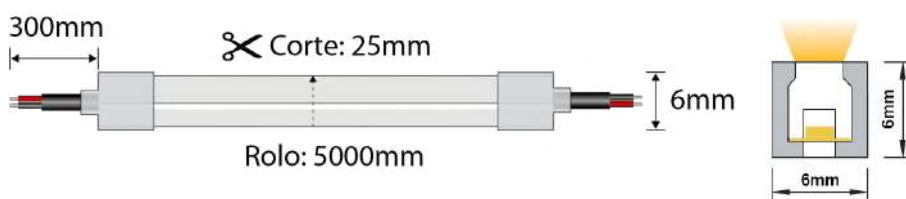
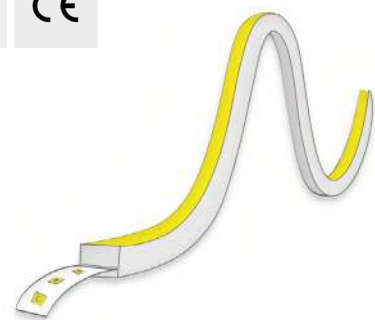

* Não inclui fixadores nem topos | No incluye clips ni tapas

ACESSÓRIOS RECOMENDADOS | ACCESORIOS RECOMENDADOS

Este modelo standard tem saída de cabo de topo.
Este modelo estándar tiene una salida de cable superior.

Tampa final
Tapa final
Ref. 2219353

Conector
Ref. 2220353

Calha fixadora AL 1mt
Perfil de fijación AL 1mt
Ref. PF164AL



NEON UP C/ ABAS **ESMERALDA** 6W IP44



Modelo	Ref.	Cor Color	Tensão Tensión	IP	Lumens /mt	Lumens /w
ESMERALDA 50000H	133213.0627	2700K	24V	IP44	378Lm	63Lm
	133213.0630	3000K	24V	IP44	381Lm	64Lm
	133213.0640	4000K	24V	IP44	397Lm	66Lm

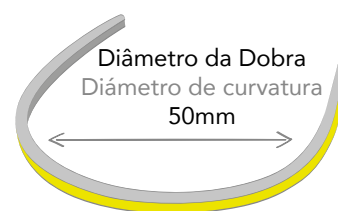
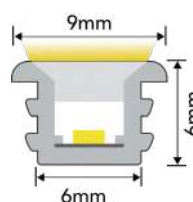
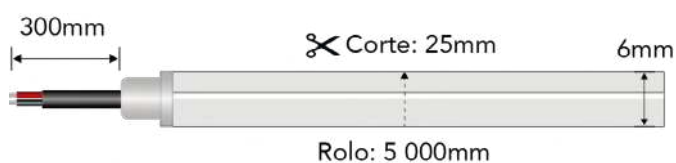
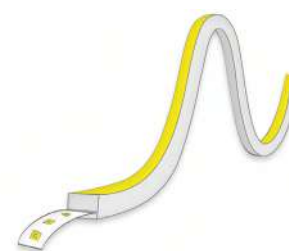

Este modelo standard tem saída de cabo de topo.
Este modelo estándar tiene una salida de cable superior.

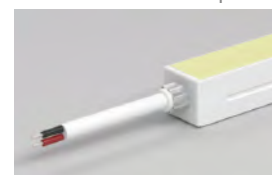

NEON UP C/ABAS BESTLA 9,6W IP65

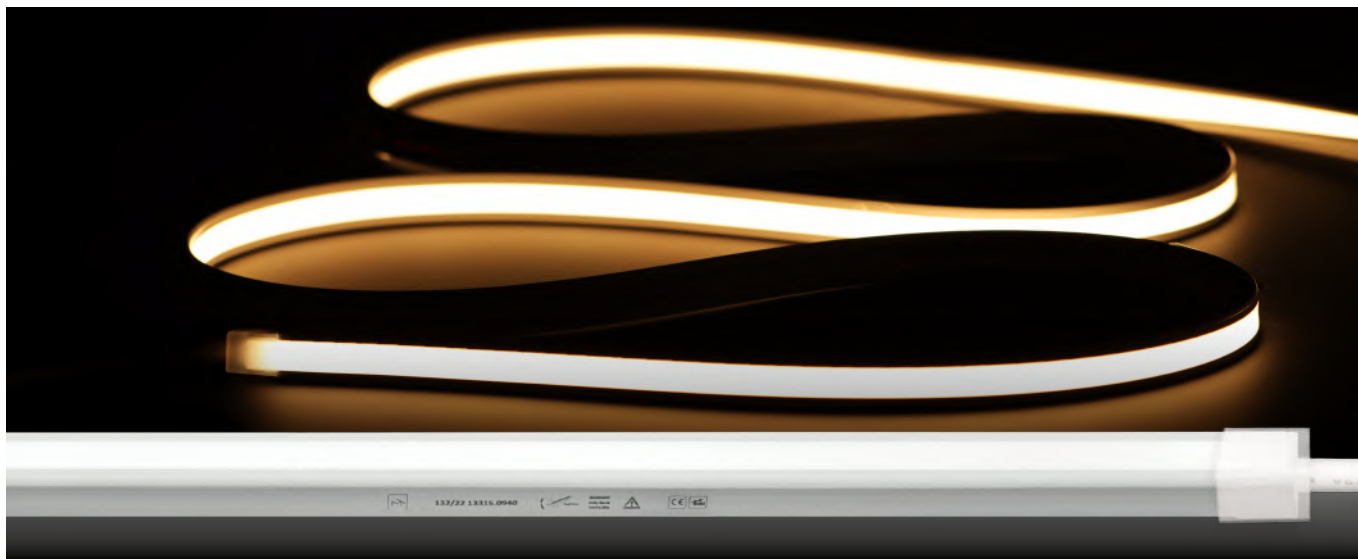

FITA LED NEON

9,6W/m
24V DC
IP65
CRI 80
5m
CONEXÃO MÁXIMA 5m
DIMÁVEL
RESISTÊNCIA UV
M M
CE

Modelo	Ref.	Cor Color	Tensão Tensión	IP	Lumens /mt	Lumens /w
BESTLA	13315.0927	2700K	24V	IP65	650Lm	68Lm
	13315.0930	3000K	24V	IP65	710Lm	74Lm
	13315.0940	4000K	24V	IP65	710Lm	74Lm

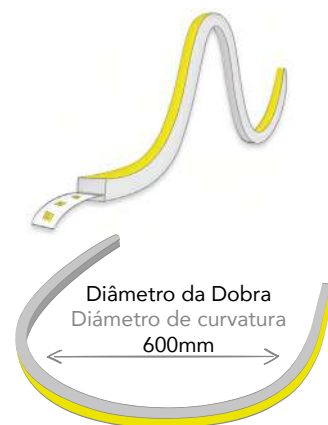

Este modelo standard tem saída de cabo de topo.
Este modelo estándar tiene una salida de cable superior.



ACESSÓRIOS RECOMENDADOS | ACCESORIOS RECOMENDADOS

Calha fixadora PL 1mt
Perfil de fijación PL 1mt
Ref. PF148PL



Calha fixadora AL 1mt
Perfil de fijación AL 1mt
Ref. PF148AL



Fixador 1010
Fijador 1010
Ref. 2226143



NEON UP ARQUE 10W IP67



Modelo	Ref.	Cor Color	Tensão Tensión	IP	Lumens /mt	Lumens /w
ARQUE	13246.1027	2700K	24V	IP67	450Lm	45Lm
	13246.1030	3000K	24V	IP67	450Lm	45Lm
	13246.1040	4000K	24V	IP67	500Lm	50Lm



Este modelo standard tem saída de cabo de topo. Este modelo estándar tiene una salida de cable superior.



ACESSÓRIOS RECOMENDADOS | ACCESORIOS RECOMENDADOS

<p>Conector Ref. 2220243</p> 	<p>Fixador 1010 Fijador 1010 Ref. 2226143</p> 	<p>Tampa final Tapa final Ref. 2219243</p> 	<p>Calha fixadora PL 1mt Perfil de fijación PL 1mt Ref. PF148PL</p> 	<p>Calha fixadora AL 1mt Perfil de fijación AL 1mt Ref. PF148AL</p> 
--	---	--	---	---

NEON UP CORTE LIVRE CARME 7,2W IP65

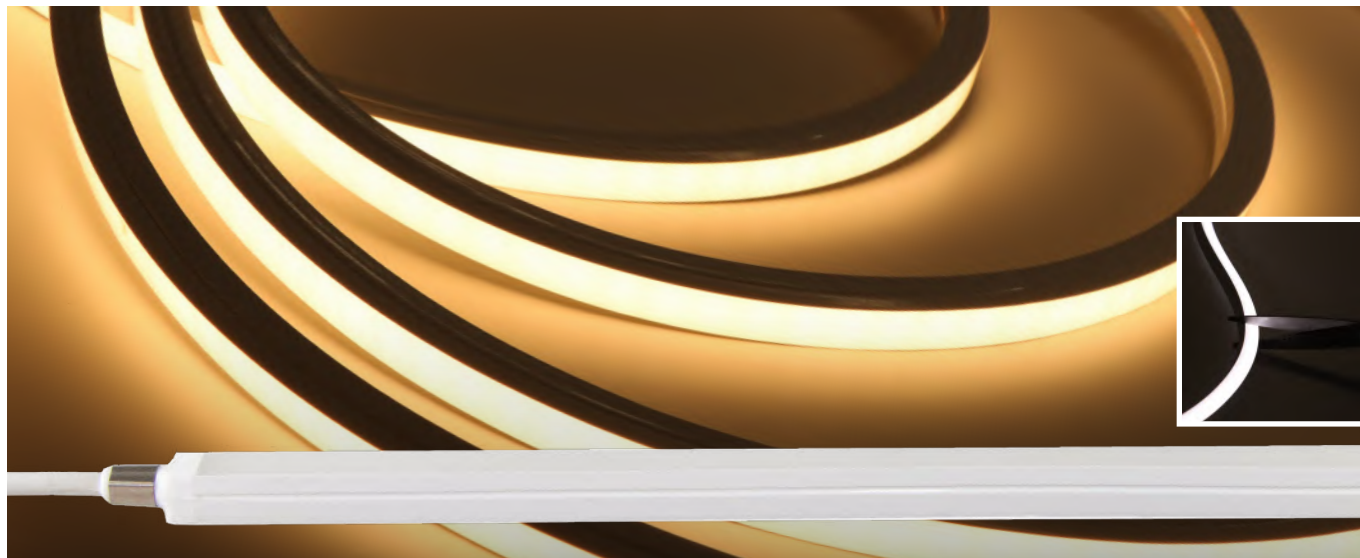

FITA LED NEON

7,2W/m
24V DC
IP65
5m
CONEXÃO MÁXIMA 5m
CORTE LIVRE
CRI 90
DIMÁVEL
RESISTÊNCIA UV
PERSONALIZE
M M
CE

Modelo	Ref.	Cor Color	Tensão Tensión	IP	Lumens /mt	Lumens /w
	1339115.0727	2700K	24V	IP65	435Lm	43Lm
CARME	1339115.0730	3000K	24V	IP65	435Lm	43Lm
	1339115.0740	4000K	24V	IP65	485Lm	48Lm

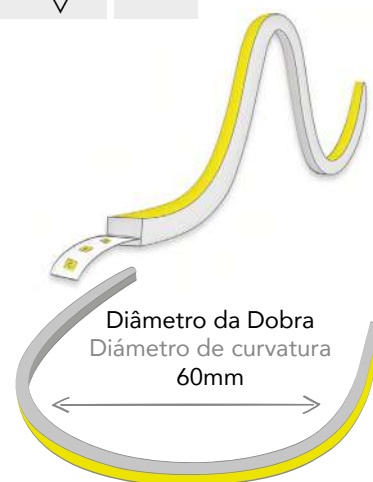
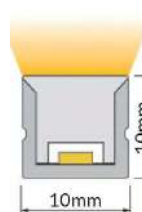

Este modelo standard tem saída de cabo de topo.
Este modelo estándar tiene una salida de cable superior.

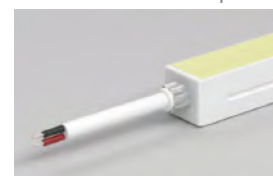

ACESSÓRIOS RECOMENDADOS | ACCESORIOS RECOMENDADOS

Tampa final
Tapa final
Ref. 2219243



Fixador 1010
Fijador 1010
Ref. 2226143



Conector
Ref. 2220243



Calha fixadora PL 1mt
Perfil de fijación PL 1mt
Ref. PF148PL



Calha fixadora AL 1mt
Perfil de fijación AL 1mt
Ref. PF148AL



NEON UP NESO 10W IP67





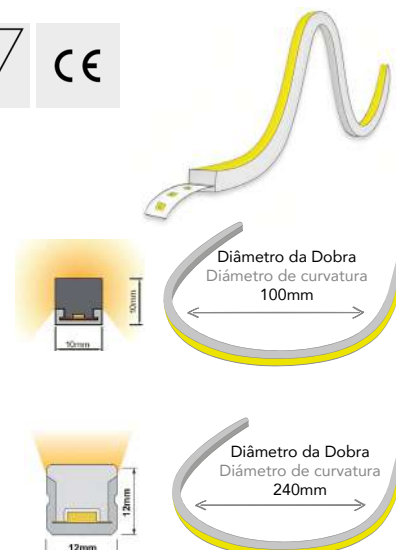





Modelo	Ref.	Cor Color	Tensão Tensión	IP	Lumens /mt	Lumens /w
NESO L70B10 54000H 2 Steps MacAdam	1322136.1027	2700K	24V	IP67	740Lm	74Lm
	1322136.1030	3000K	24V	IP67	790Lm	79Lm
	1322136.1040	4000K	24V	IP67	830Lm	83Lm
L80 30000H 1BIN	1368136.10RGB	RGB	24V	IP67	R: 330Nm G: 920Nm B: 175Nm	R: 33Nm G: 92Nm B: 17,5Nm

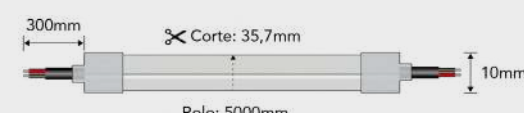
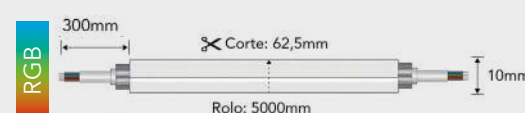

Este modelo standard tem saída de cabo de topo.

Este modelo estándar tiene una salida de cable superior.

ACESSÓRIOS RECOMENDADOS | ACCESORIOS RECOMENDADOS

<p>Conector Ref. 2220243</p> 	 <p>Rolo: 5000mm</p>			 <p>Rolo: 5000mm</p>		
<p>Fixador 1010 Fijador 1010 Ref. 2226143</p> 	<p>Tampa final Tapa final Ref. 2219243</p> 	<p>Calha fixadora Perfil de fijación PL 1mt Ref. PF148PL</p> 	<p>Calha fixadora Perfil de fijación AL 1mt Ref. PF148AL</p> 	<p>Fixador 1212 Fijador 1212 Ref. 2226162</p> 	<p>Tampa final Tapa final Ref. 2219657</p> 	<p>Calha fixadora Perfil de fijación AL 1mt Ref. PF149AL</p> 

NEON UP BLACK MÉTIS 10W IP67



FITA LED NEON



Modelo	Ref.	Cor Color	Tensão Tensión	IP	Lumens /mt	Lumens /w
BLACK MÉTIS	1313226.1027	2700K	24V	IP67	20,6Lm	2Lm
L70B10 54000H	1313226.1030	3000K	24V	IP67	21,1Lm	2Lm
2 Steps MacAdam	1313226.1040	4000K	24V	IP67	20,7Lm	2Lm

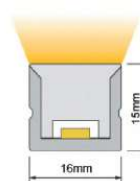
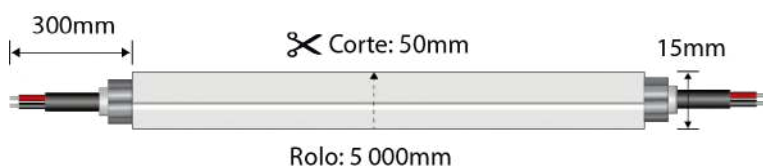

Este modelo standard tem saída de cabo de topo.
Este modelo estándar tiene una salida de cable superior.



DESTAQUE | DESTACADO

Acabamento mate | Acabado mate

ACESSÓRIOS RECOMENDADOS | ACCESORIOS RECOMENDADOS

Tampa final
Tapa final
Ref. 2219253



Calha fixadora PL 1mt
Perfil de fijación PL 1mt
Ref. PF152PL



Calha fixadora AL 1mt
Perfil de fijación AL 1mt
Ref. PF152AL



Fixador 1615
Fijador 1615
Ref. 2226144



NEON UP LAZÚLI 10W IP67



Modelo	Ref.	Cor Color	Tensão Tensión	IP	Lumens /mt	Lumens /w
LAZÚLI	13613136.1027	2700K	24V	IP67	590Lm	59Lm
	13613136.1030	3000K	24V	IP67	590Lm	59Lm
	13613136.1040	4000K	24V	IP67	630Lm	63Lm
	13613136.10RGB	RGB	24V	IP67	R: 67Nm; G: 176Nm; B: 34Nm	

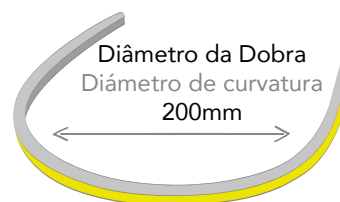
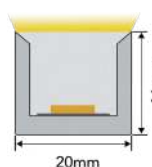
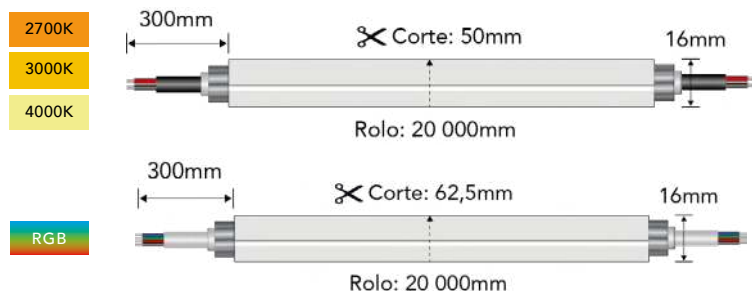
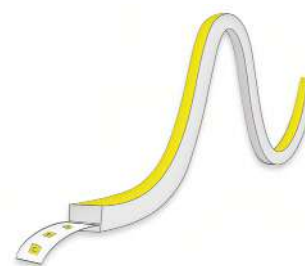

ACESSÓRIOS RECOMENDADOS | ACCESORIOS RECOMENDADOS

Calha fixadora AL 1mt
Perfil de fijación AL 1mt
Ref. PF1107AL

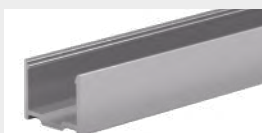

Este modelo standard tem saída de cabo de topo.
Este modelo estándar tiene una salida de cable superior.







**NEON
SIDE**

Neón Side

NEON SIDE BLENDA 6W IP65



FITA LED NEON

6W/m
24V DC
IP65
CRI ≥90
5m
CONEXÃO MÁXIMA 5m
DIMÁVEL
RESISTÊNCIA UV
PERSONALIZE
M M
CE
NOVO NUEVO

Modelo	Ref.	Cor Color	Tensão Tensión	IP	Lumens /mt	Lumens /w
BLENDAS 50000H	13149115.0627	2700K	24V	IP65	168Lm	28Lm
	13149115.0630	3000K	24V	IP65	185Lm	31Lm
	13149115.0640	4000K	24V	IP65	185Lm	31Lm

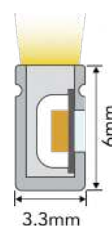
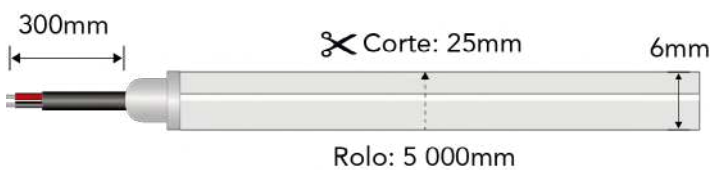

Este modelo standard tem saída de cabo de topo.
Este modelo estándar tiene una salida de cable superior.



ACESSÓRIOS RECOMENDADOS | ACCESORIOS RECOMENDADOS

<p>Calha Fixadora AL 1mt Perfil de Fijación AL 1mt Ref. PF1142AL</p> 	<p>Tampa final Silicone Tapa final Silicona Ref. 2219781</p> 	<p>Ligador com cabo Ligador con cable Ref. 2220781</p> 
--	--	--

NEON SIDE JÁPETO 6W IP66

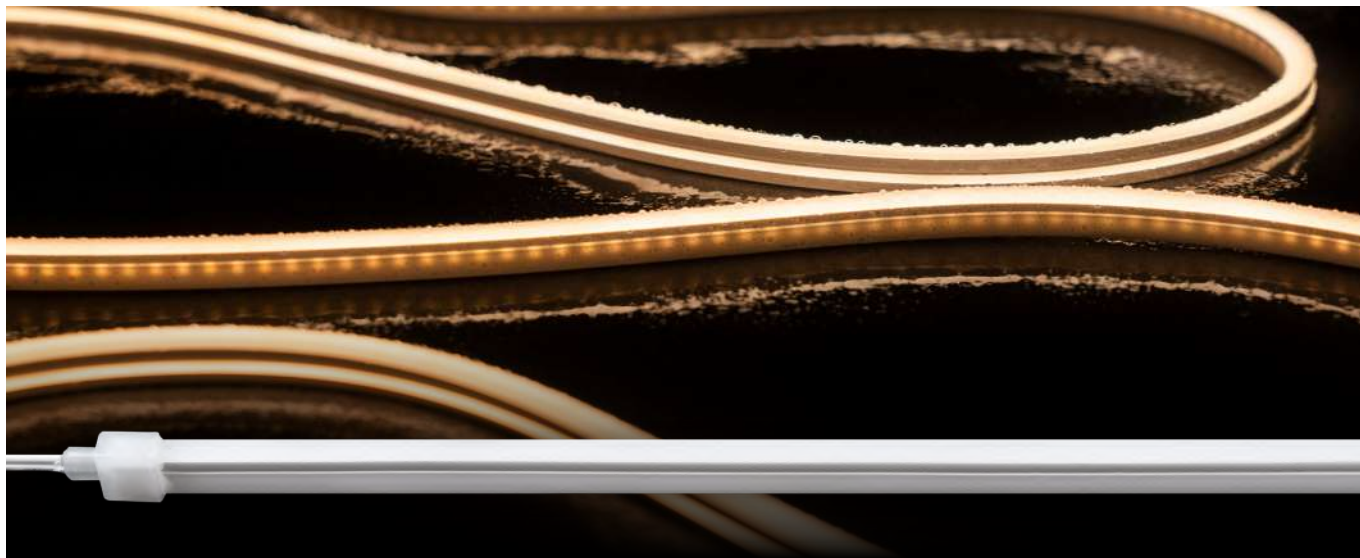

Modelo	Ref.	Cor Color	Tensão Tensión	IP	Lumens /mt	Lumens /w
	1394146.0627	2700K	24V	IP66	138Lm	23Lm
JÁPETO L70B50 5000H	1394146.0630	3000K	24V	IP66	256Lm	43Lm
3 Steps MacAdam	1394146.0640	4000K	24V	IP66	250Lm	42Lm
	1394146.0653	5000K	24V	IP66	253Lm	42Lm

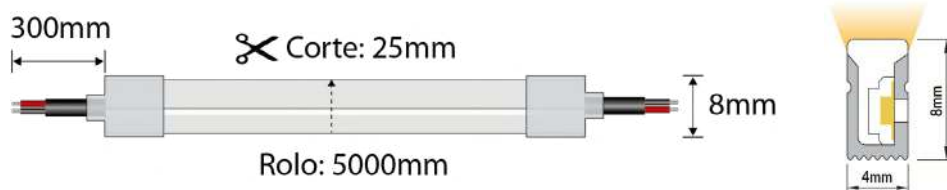
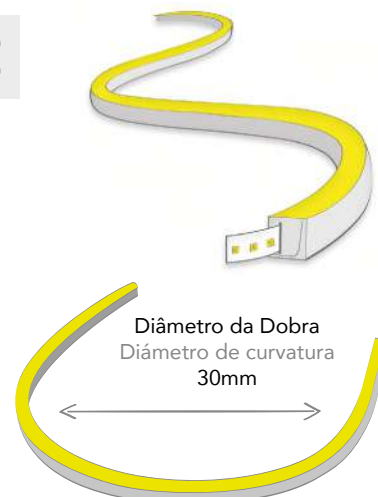

Este modelo standard tem saída de cabo de topo. Este modelo estándar tiene una salida de cable superior.

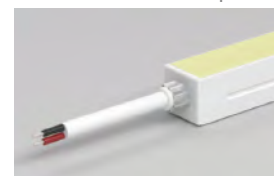

ACESSÓRIOS RECOMENDADOS | ACCESORIOS RECOMENDADOS

Tampa final
Tapa final
Ref. 2219355

Ligador c/ cabo
Conector c/ cable
Ref. 2220355

Calha fixadora AL 1mt
Perfil de fijación AL 1mt
Ref. PF156AL



NEON SIDE C/ABAS CALDENE 9,6W IP65

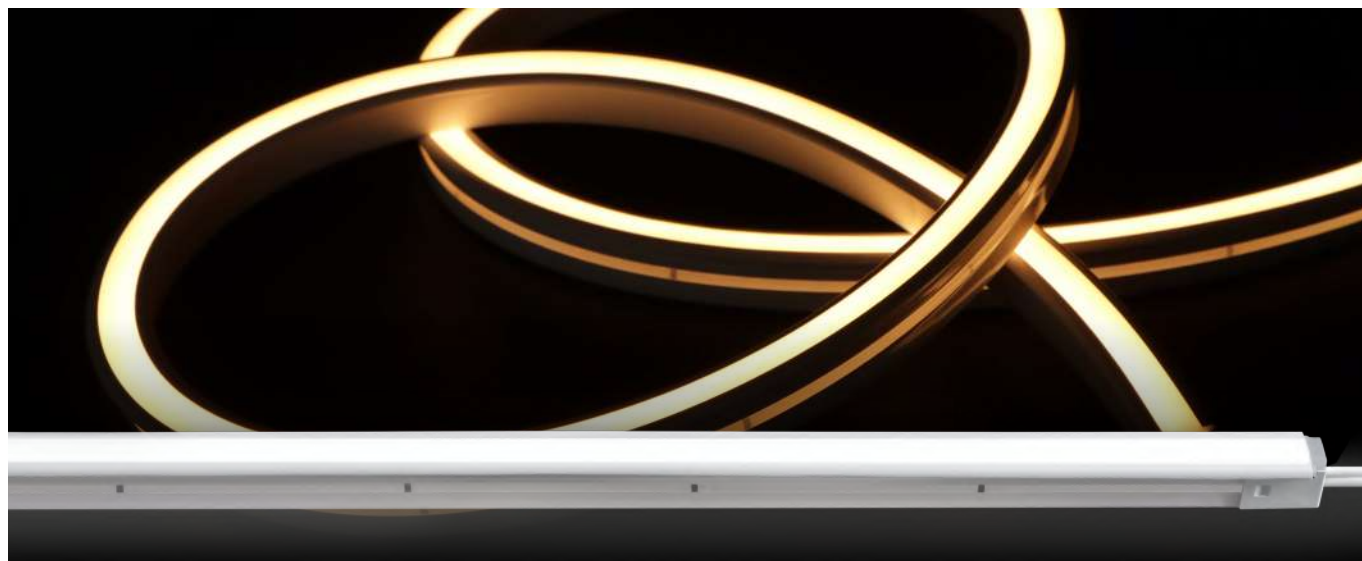

FITA LED NEON



Modelo	Ref.	Cor Color	Tensão Tensión	IP	Lumens /mt	Lumens /w
CALDENE 30000H	13325.0927	2700K	24V	IP65	280Lm	29Lm
	13325.0930	3000K	24V	IP65	320Lm	33Lm
	13325.0937	3700K	24V	IP65	330Lm	34Lm

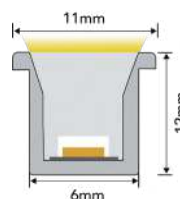
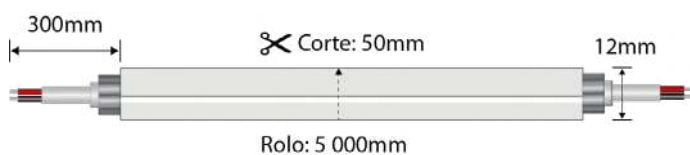
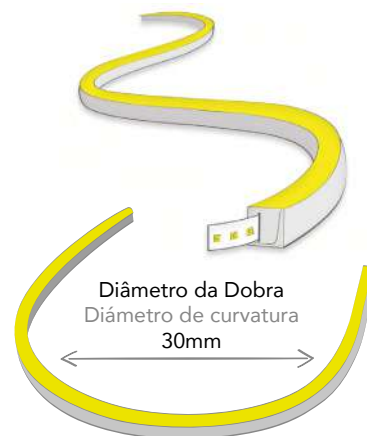

Este modelo standard tem saída de cabo de topo.
Este modelo estándar tiene una salida de cable superior.



ACESSÓRIOS RECOMENDADOS | ACCESORIOS RECOMENDADOS

Calha fixadora AL 1mt
Perfil de fijación AL 1mt
Ref. PF150AL

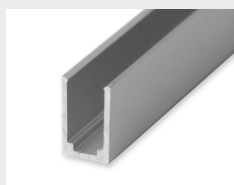

Calha fixadora flexível inox 0,5mt
Perfil de fijación flexible de acero inoxidable 0,5mt | Ref. PF154IX



Fixador 0612
Fixador 0612
Ref. 2226148



NEON SIDE MINI NIX 10W IP67



Modelo	Ref.	Cor Color	Tensão Tensión	IP	Lumens /mt	Lumens /w
MINI NIX	132166.1027	2700K	24V	IP67	400Lm	40Lm
L70B10 54000H	132166.1030	3000K	24V	IP67	435Lm	44Lm
2 Steps MacAdam	132166.1040	4000K	24V	IP67	413Lm	41Lm
L80 3000H 1 BIN	1328166.10RGB	RGB	24V	IP67	R: 625Nm G: 532Nm B: 475Nm	

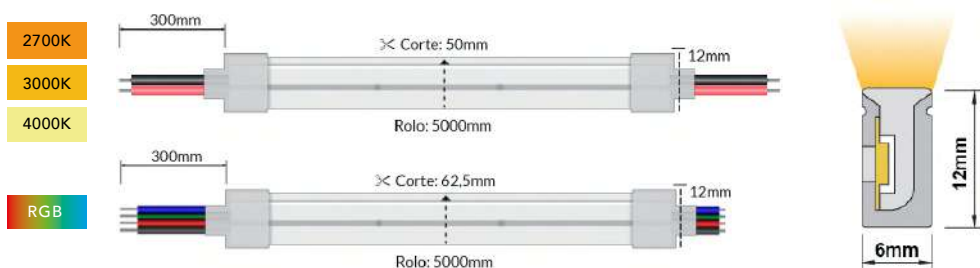
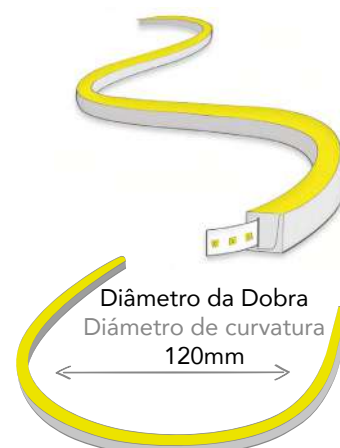

Este modelo standard tem saída de cabo de topo. Este modelo estándar tiene una salida de cable superior.

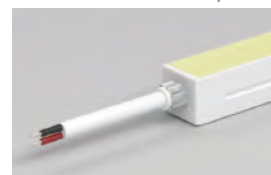

ACESSÓRIOS RECOMENDADOS | ACCESORIOS RECOMENDADOS

Tampa final Tapa final Ref. 2214216	Conector Ref. 2220248	Calha fixadora AL 1mt Perfil de fijación AL 1mt Ref. PF150AL	Calha fixadora flexível inox 0,5mt Perfil de fijación flexible de acero inoxidable 0,5mt Ref. PF154IX	Fixador 0612 Fixador 0612 Ref. 2226148

NEON SIDE FEBE 10W IP67



FITA LED NEON



Modelo	Ref.	Cor Color	Tensão Tensión	IP	Lumens /mt	Lumens /w
	13256.1027	2700K	24V	IP67	450Lm	45Lm
FEBE	13256.1030	3000K	24V	IP67	450Lm	45Lm
	13256.1040	4000K	24V	IP67	500Lm	50Lm

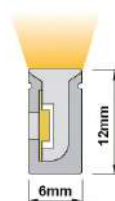
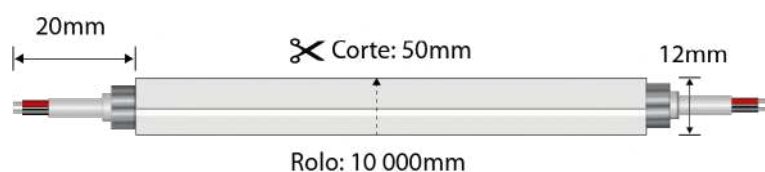

Este modelo standard tem saída de cabo de topo.
Este modelo estándar tiene una salida de cable superior.



ACESSÓRIOS RECOMENDADOS | ACCESORIOS RECOMENDADOS

Tampa final Tapa final Ref. 2214216	Conector Ref. 2220248	Calha fixadora AL 1mt Perfil de fijación AL 1mt Ref. PF150AL	Calha fixadora flexível inox 0,5mt Perfil de fijación flexible de acero inoxidable 0,5mt Ref. PF154IX	Fixador 0612 Fixador 0612 Ref. 2226148

NEON SIDE CORTE LIVRE HELIQUE 7,2W IP65



Modelo	Ref.	Cor Color	Tensão Tensión	IP	Lumens /mt	Lumens /w
	1340115.0727	2700K	24V	IP65	350Lm	49Lm
HELIQUE	1340115.0730	3000K	24V	IP65	350Lm	49Lm
	1340115.0740	4000K	24V	IP65	370Lm	51Lm

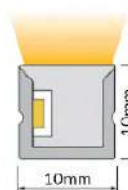
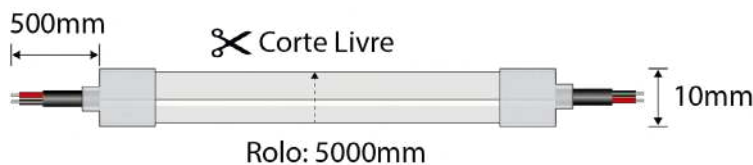
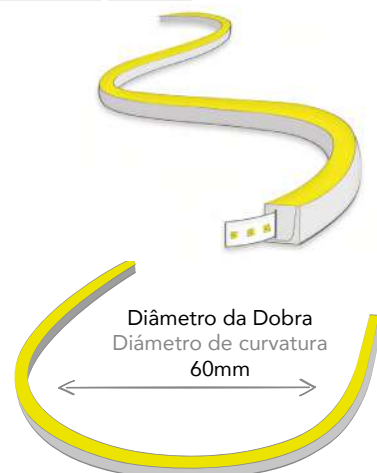

Este modelo standard tem saída de cabo de topo.
Este modelo estándar tiene una salida de cable superior.



ACESSÓRIOS RECOMENDADOS | ACCESORIOS RECOMENDADOS

<p>Fixador 1010 Fijador 1010 Ref. 2226143</p> 	<p>Tampa final Tapa final Ref. 2219243</p> 	<p>Calha fixadora Perfil de fijación PL 1mt Ref. PF148PL</p> 	<p>Calha fixadora Perfil de fijación AL 1mt Ref. PF148AL</p> 	<p>Conector Ref. 2220243</p> 
---	--	--	---	--

NEON SIDE ISONOE 10W IP67

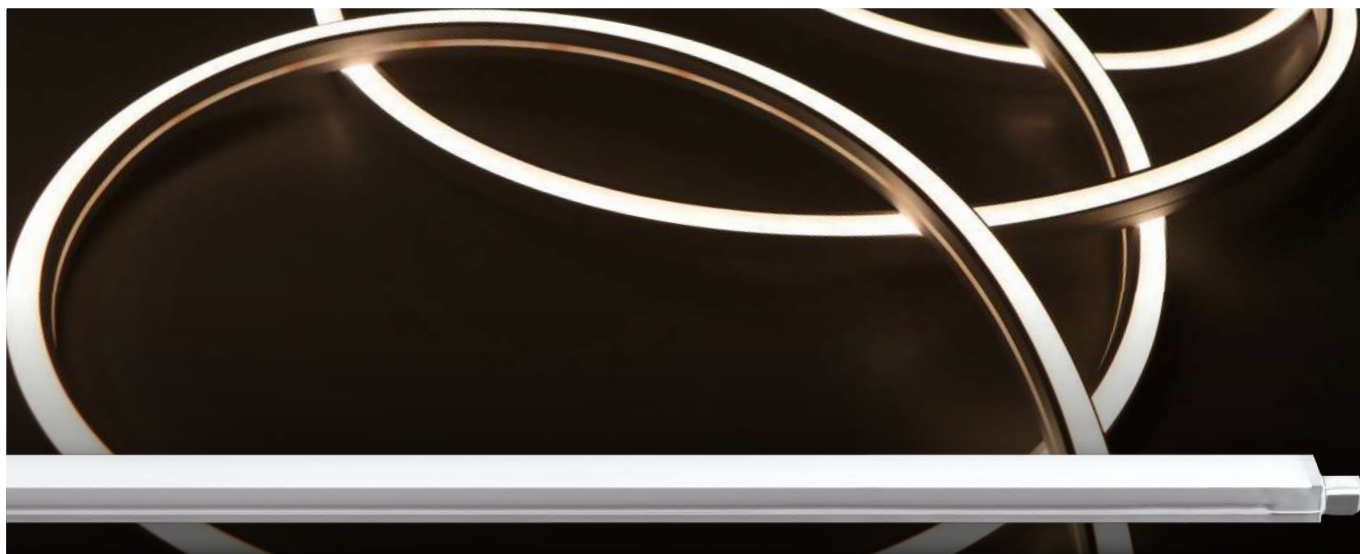

FITA LED NEON

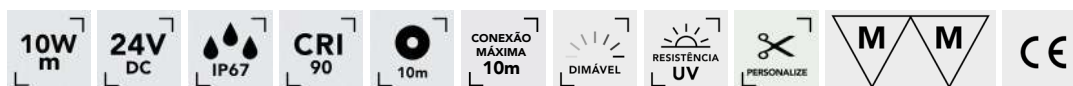

Modelo	Ref.	Cor Color	Tensão Tensión	IP	Lumens /mt	Lumens /w
	1323116.1027	2700K	24V	IP67	571Lm	57Lm
ISONOE	1323116.1030	3000K	24V	IP67	623Lm	62Lm
	1323116.1040	4000K	24V	IP67	660Lm	66Lm

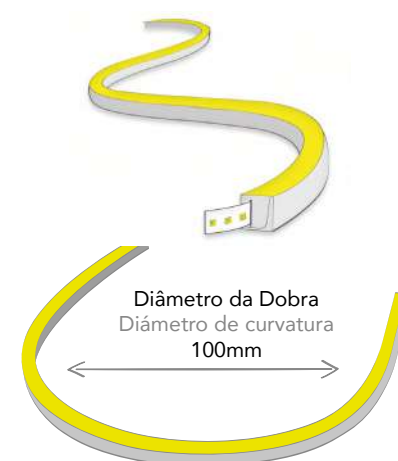
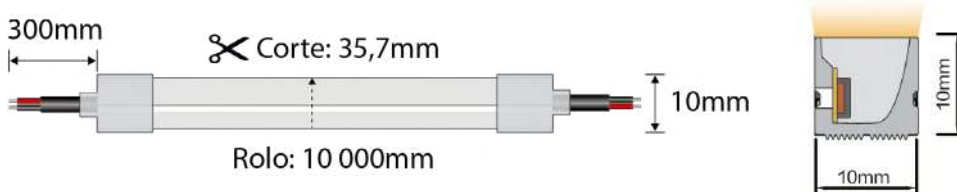

Este modelo standard tem saída de cabo de topo.
Este modelo estándar tiene una salida de cable superior.



ACESSÓRIOS RECOMENDADOS | ACCESORIOS RECOMENDADOS

<p>Tampa final Tapa final Ref. 2219243</p>	<p>Fixador 1010 Fijador 1010 Ref. 2226143</p>	<p>Conector Ref. 2220243</p>	<p>Calha fixadora PL 1mt Perfil de fijación PL 1mt Ref. PF148PL</p>	<p>Calha fixadora Perfil de fijación AL 1mt Ref. PF148AL</p>
--	---	----------------------------------	---	--

NEON SIDE GREIP 12W IP67

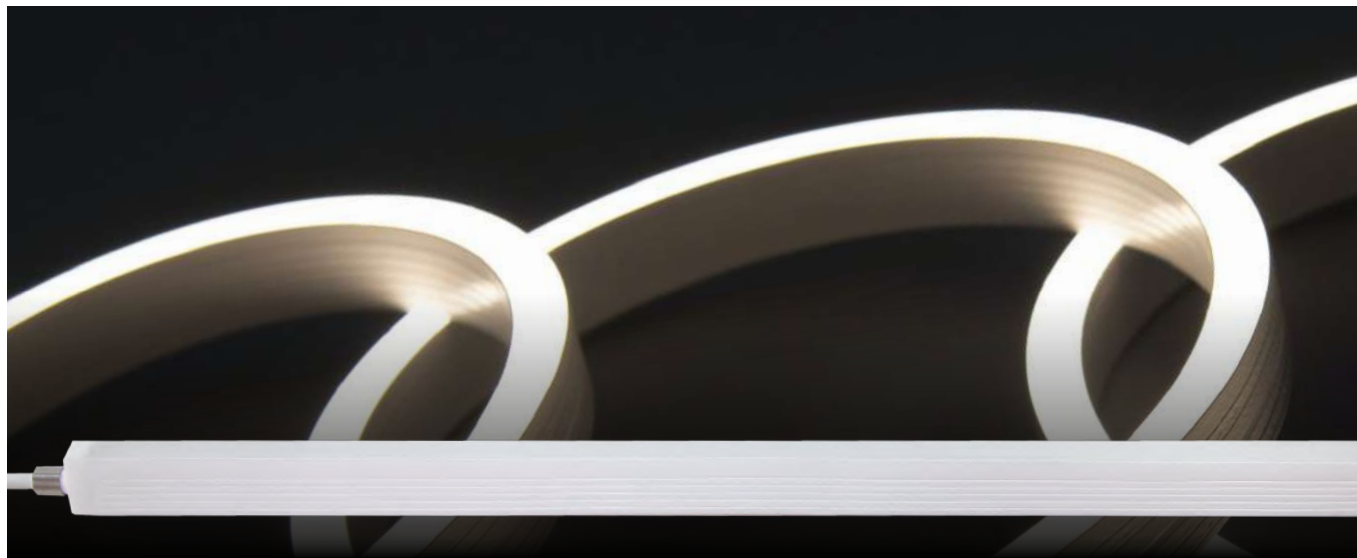

Modelo	Ref.	Cor Color	Tensão Tensión	IP	Lumens /mt	Lumens /w
GREIP	13256.1227	2700K	24V	IP67	540Lm	45Lm
	13256.1230	3000K	24V	IP67	540Lm	45Lm
	13256.1240	4000K	24V	IP67	600Lm	50Lm

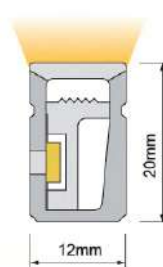
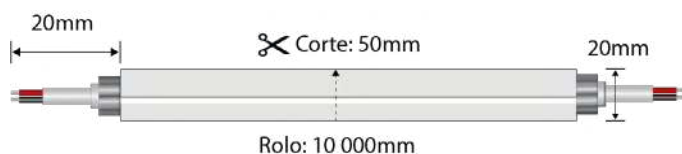
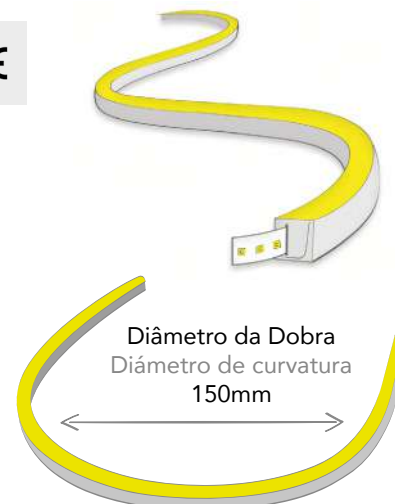

Este modelo standard tem saída de cabo de topo.
Este modelo estándar tiene una salida de cable superior.



ACESSÓRIOS RECOMENDADOS | ACCESORIOS RECOMENDADOS

<p>Tampa final Tapa final Ref. 2219247</p> 	<p>Tampa final Tapa final Ref. 2214226</p> 	<p>Conector Ref. 2220247</p> 	<p>Calha fixadora Perfil de fijación AL 1mt Ref. PF151AL</p> 	<p>Fixador 1220 Fijador 1220 Ref. 2226147</p> 	<p>Calha fixadora flexível inox Perfil de fijación flexible de acero inoxidable Ref. PF151IX - 0,5mt Ref. PF151IX.1 - 1mt</p> 
--	--	--	--	---	---

NEON SIDE BLACK NARVI 10W IP67

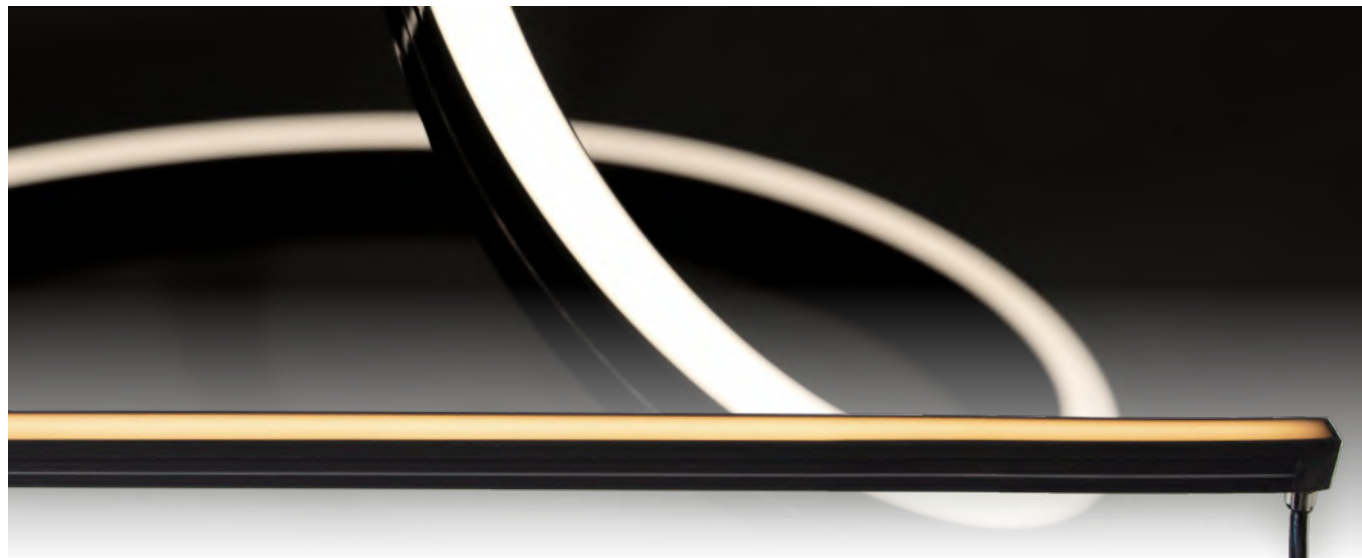

FITA LED NEON



Modelo	Ref.	Cor Color	Tensão Tensión	IP	Lumens /mt	Lumens /w
BLACK NARVI	1313246.1027	2700K	24V	IP67	17,2Lm	1,72Lm
L70B10 54000H	1313246.1030	3000K	24V	IP67	17,8Lm	1,78Lm
2 Steps MacAdam	1313246.1040	4000K	24V	IP67	19,5Lm	1,95Lm

* Este modelo encontra-se disponível em cinzento.
* Este modelo está disponible en gris.

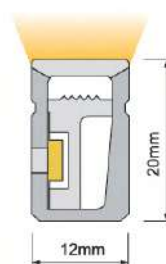
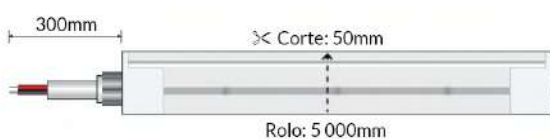

Este modelo standard tem saída de cabo de topo.
Este modelo estándar tiene una salida de cable superior.



DESTAQUE | DESTACADO

Acabamento mate | Acabado mate

ACESSÓRIOS RECOMENDADOS | ACCESORIOS RECOMENDADOS

Tampa final Tapa final Ref. 2219247	Tampa final Tapa final Ref. 2214226	Conector Ref. 2220247	Calha fixadora Perfil de fijación AL 1mt Ref. PF151AL	Fixador 1220 Fijador 1220 Ref. 2226147	Calha fixadora flexível inox Perfil de fijación flexible de acero inoxidable Ref. PF151IX - 0,5mt Ref. PF151IX.1 - 1mt

NEON SIDE NARVI 15W IP67

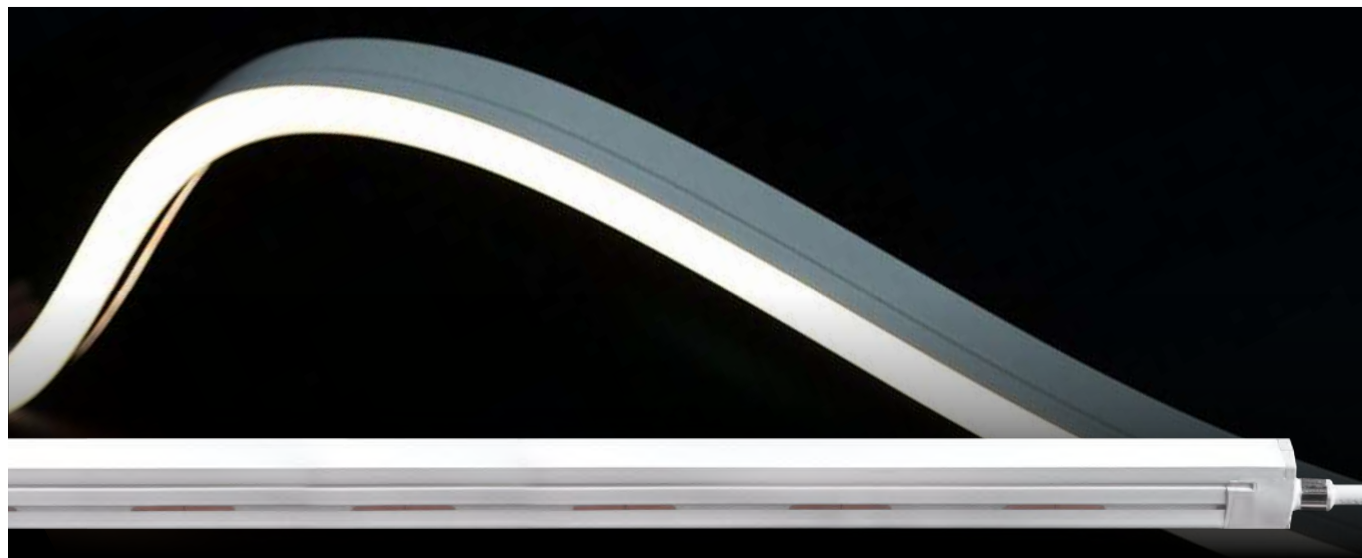

Modelo	Ref.	Cor Color	Tensão Tensión	IP	Lumens /mt
NARVI L70B10 54000H 2 Steps MacAdam	1321146.1527	2700K	24V	IP67	436Lm
	1321146.1530	3000K	24V	IP67	492Lm
	1321146.1540	4000K	24V	IP67	475Lm
L80 30000H 1Bin	1310146.14RGB	RGB	24V	IP67	R:625Nm G:532Nm B:475Nm

15W/m

11W/m

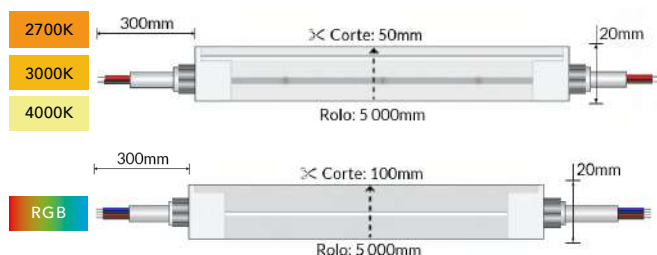
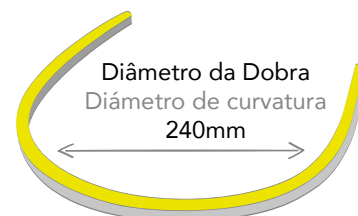

Este modelo standard tem saída de cabo de topo.
Este modelo estándar tiene una salida de cable superior.



ACESSÓRIOS RECOMENDADOS | ACCESORIOS RECOMENDADOS

Tampa final Tapa final Ref. 2219247	Tampa final Tapa final Ref. 2214226	Conector Ref. 2220247	Calha fixadora Perfil de fijación AL 1mt Ref. PF151AL	Fixador 1220 Fijador 1220 Ref. 2226147	Calha fixadora flexível inox Perfil de fijación flexible de acero inoxidable Ref. PF151IX - 0,5mt Ref. PF151IX.1 - 1mt





NEON AQUA

Neon Led / Neón Led

NEON UP **HIDRA** - PISCINA 10W IP68

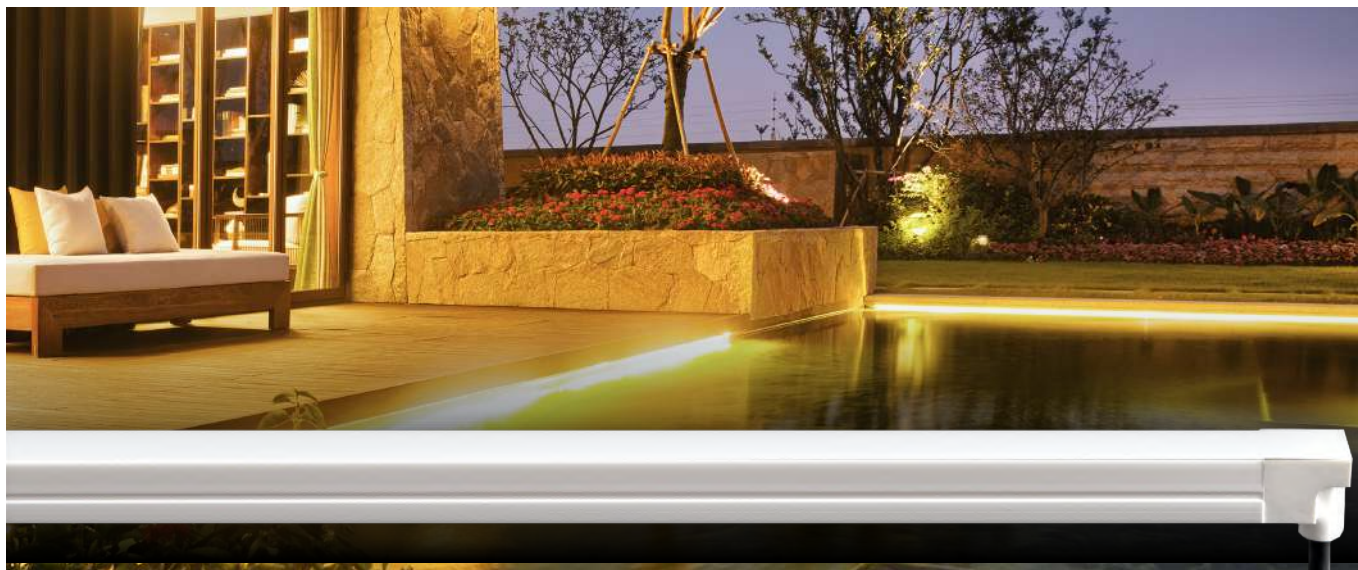

LED NEON AQUA

10W/m
24V DC
IP68
CRI 90
5m
CONEXÃO MÁXIMA 5m
DIMÁVEL
RESISTÊNCIA UV
SUBMERSÍVEL
RESISTENTE ÁGUA SALGADA
RESISTENTE QUÍMICOS
M M
CE

Modelo	Ref.	Cor Color	Tensão Tensión	IP	Lumens/mt
HIDRA	13251227.1027	2700K	24V	IP68	616Lm
L70B10	13251227.1030	3000K	24V	IP68	655Lm
54000H	13251227.1040	4000K	24V	IP68	698Lm
2 Steps MacAdam	13251227.1065	6500K	24V	IP68	637Lm
L80	13268227.10RGB	RGB	24V	IP68	R:56Nm G:182Nm B:35Nm
30000H 1BIN					

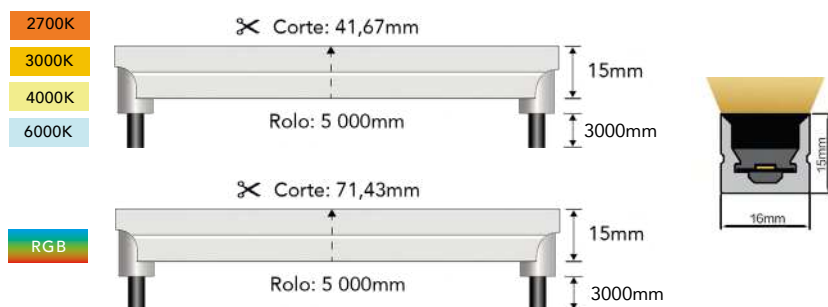

Possibilita uma linha de luz contínua na união de duas fitas resultante da saída inferior do cabo.

Permite una línea continua de luz en la unión de dos tiras resultantes de la salida inferior del cable.



Não inclui fixadores nem topos.
No incluye fijador ni tapas.

ACESSÓRIOS RECOMENDADOS ACCESORIOS RECOMENDADOS

Tampa final
Tapa final
Ref. 2219253

Calha fixadora PL 1mt
Perfil de fijación PL 1mt
Ref. PF152PL



Personalização de cabo só é feita sob encomenda à fábrica.*
La personalización del cable solo se realiza mediante pedido de fábrica.*

Este modelo tem disponível as seguintes saídas de cabo: | Este modelo dispone de las siguientes salidas de cable:



*Sujeito a confirmação de prazo de entrega.
Sujeto a confirmación del tiempo de entrega.

NEON UP **DAFNE** - PISCINA 10W IP68



Modelo	Ref.	Cor Color	Tensão Tensión	IP	Lumens /mt	Lumens /w
DAFNE 54000H	1322127.1030	3000K	24V	IP68	375Lm	38Lm
	1322127.1040	4000K	24V	IP68	410Lm	41Lm
	1322127.1060	6000K	24V	IP68	375Lm	38Lm
DAFNE RGB	1322127.10RGB	RGB	24V	IP68	R:54Nm G:201Nm B:40Nm	

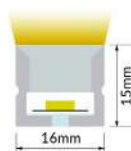
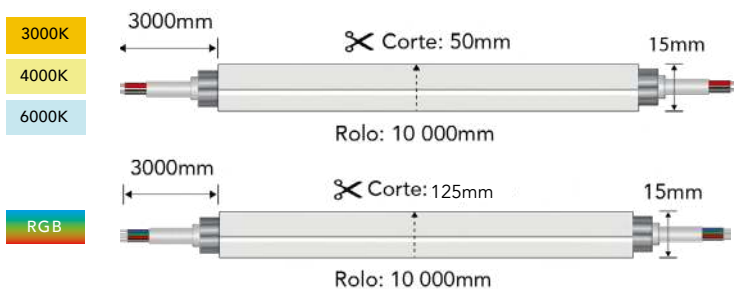

Este modelo standard tem saída de cabo de topo.
Este modelo estándar tiene una salida de cable superior.



ACESSÓRIOS RECOMENDADOS | ACCESORIOS RECOMENDADOS

<p>Tampa final Tapa final Ref. 2219253</p> 	<p>Calha fixadora PL 1mt Perfil de fijación PL 1mt Ref. PF152PL</p> 
--	---

Personalização de cabo só é feita sob encomenda à fábrica.*

La personalización del cable solo se realiza mediante pedido de fábrica.*

Não inclui fixadores nem topos.

No incluye fijador ni tapas.

*Sujeito a confirmação de prazo de entrega. Sujeto a confirmación del tiempo de entrega.

NEON UP SETEBOS - PISCINA IP68

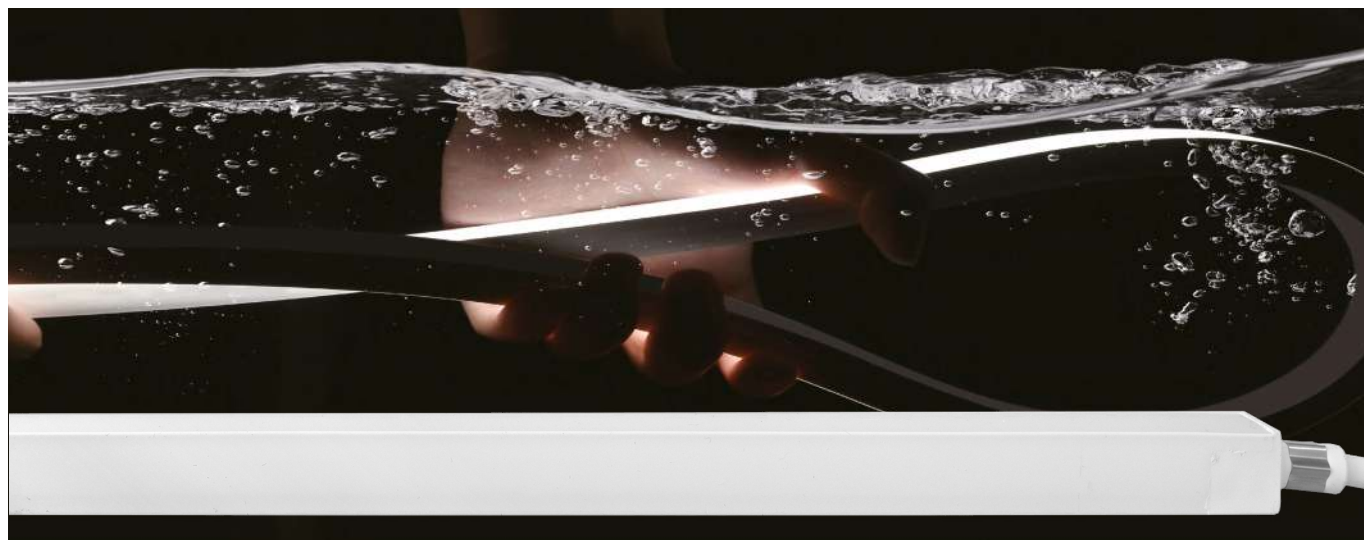

LED NEON AQUA

Diâmetro da Dobra
Diámetro de curvatura
200mm

Modelo	Ref.	Cor Color	Tensão Tensión	Lumens /mt	Potência /mt	Rolo Rollo
SETEBOS NEON UP	136.0527	2700K	24V	240Lm	5W	20mt
	136.1027	2700K	24V	480Lm	10W	15mt
	136.1527	2700K	24V	720Lm	15W	12mt
	136.0530	3000K	24V	245Lm	5W	20mt
	136.1030	3000K	24V	490Lm	10W	15mt
	136.1530	3000K	24V	735Lm	15W	12mt
	136.0540	4000K	24V	270Lm	5W	20mt
	136.1040	4000K	24V	540Lm	10W	15mt
	136.1540	4000K	24V	810Lm	15W	12mt
	136.0565	6500K	24V	250Lm	5W	20mt
	136.1065	6500K	24V	500Lm	10W	15mt
	136.1565	6500K	24V	750Lm	15W	12mt
	136.07RGB	RGB	24V	172Nm	7W	15mt
	136.09RGB	RGB	24V	233Nm	9W	13mt
136.12RGB	RGB	24V	311Nm	12W	12mt	

ACESSÓRIOS RECOMENDADOS
ACCESORIOS RECOMENDADOS

Calha fixadora PL 1mt
Perfil de fijación PL 1mt
Ref. PF196PL



Calha fixadora para encastrar PL 1mt
Perfil de fijación empotrado PL 1mt
Ref. PF296PL



Fixador 1617
Fijador 1617
Ref. 2226272

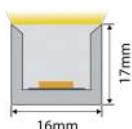
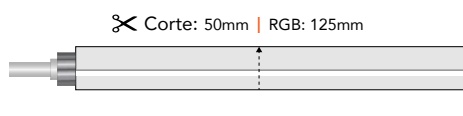

COMPOSIÇÃO DA REFERÊNCIA:



Este modelo tem disponível as seguintes saídas de cabo: | Este modelo dispone de las siguientes salidas de cable:



Fita sob encomenda. Tira por encargo.

CARACTERÍSTICAS DE PERSONALIZAÇÃO
FUNCIONES DE PERSONALIZACIÓN

- a. Comprimento da fita neon. Longitud de la cinta de neón.
- b. Comprimento do cabo. Tamaño del cable.
- c. Direção do cabo. Dirección del cable.

Medida de rolo disponível até 20mt. Tamanho de rolo disponible un máximo de 20 metros.

NEON SIDE TELESTO - PISCINA IP68

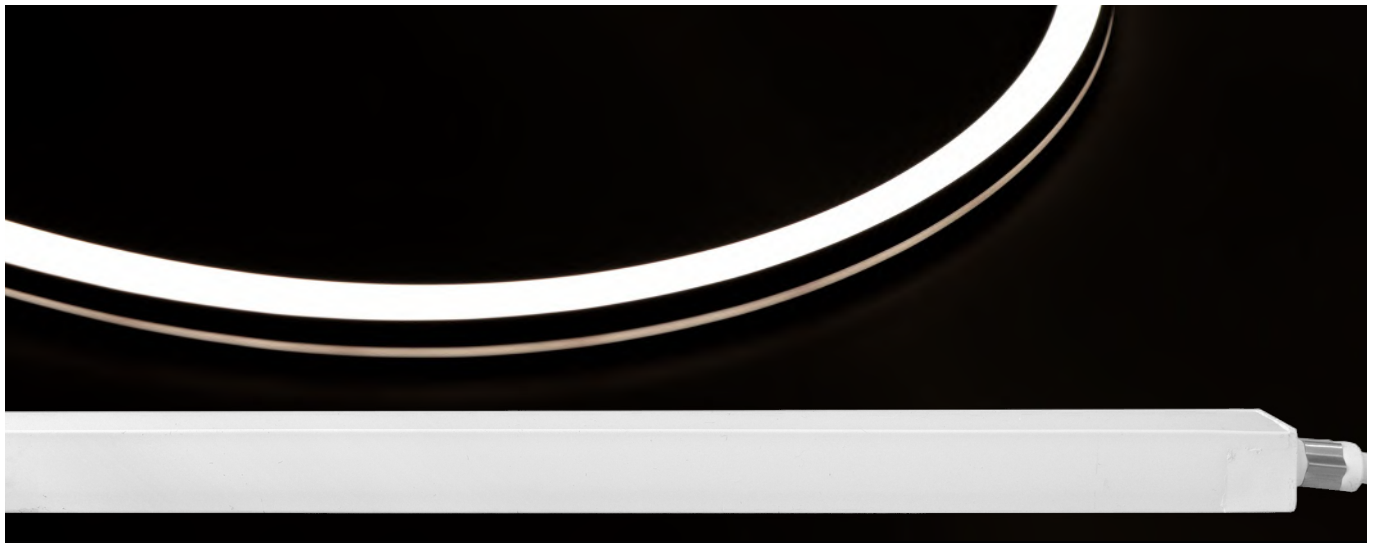

Modelo	Ref.	Cor Color	Tensão Tensión	Lumens /mt	Potência /mt	Rolo Rollo
NEON SIDE TELESTO	135.0527	2700K	24V	270Lm	5W	20mt
	135.1027	2700K	24V	540Lm	10W	15mt
	135.1527	2700K	24V	810Lm	15W	12mt
	135.0530	3000K	24V	275Lm	5W	20mt
	135.1030	3000K	24V	550Lm	10W	15mt
	135.1530	3000K	24V	825Lm	15W	12mt
	135.0540	4000K	24V	310Lm	5W	20mt
	135.1040	4000K	24V	620Lm	10W	15mt
	135.1540	4000K	24V	930Lm	15W	12mt
	135.0565	6500K	24V	280Lm	5W	20mt
	135.1065	6500K	24V	560Lm	10W	15mt
	135.1565	6500K	24V	840Lm	15W	12mt
	135.07RGB	RGB	24V	198Nm	7W	15mt
	135.09RGB	RGB	24V	267Nm	9W	13mt
	135.12RGB	RGB	24V	357Nm	12W	12mt



ACESSÓRIOS RECOMENDADOS
ACCESORIOS RECOMENDADOS

Calha fixadora PL 1mt
Perfil de fijación PL 1mt
Ref. PF196PL



Calha fixadora para encastrar PL 1mt
Perfil de fijación empotrado PL 1mt
Ref. PF296PL



Fixador 1617
Fijador 1617
Ref. 2226272

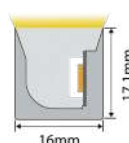
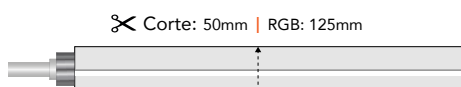

COMPOSIÇÃO DA REFERÊNCIA:
135.0527.1.20000.03

↓ Família ↓ Potência ↓ Direção Cabo ↓ Medida Neon ↓ Medida Cabo

Este modelo tem disponível as seguintes saídas de cabo: | Este modelo dispone de las siguientes salidas de cable:



Fita sob encomenda. Tira por encargo.

CARACTERÍSTICAS DE PERSONALIZAÇÃO
FUNCIONES DE PERSONALIZACIÓN

1. Comprimento da fita neon. Longitud de la cinta de neón.
2. Comprimento do cabo. Tamaño del cable.
3. Direção do cabo. Dirección del cable.

Medida de rolo disponível até 20mt. Tamaño de rolo disponible un máximo de 20 metros.

NEON SIDE **LARISSA** - PISCINA 10W IP68

LED NEON AQUA

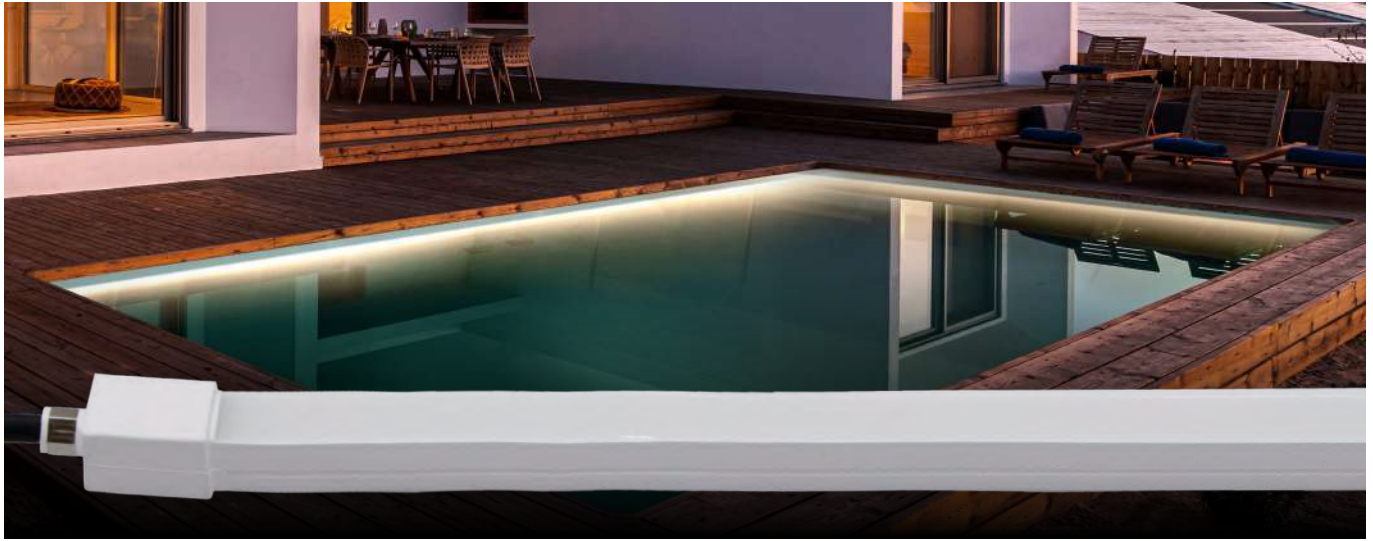

10W m	24V DC	IP68	CRI 90	10m	CONEXÃO MÁXIMA 10m	DIMÁVEL	SUBMERSÍVEL	RESISTÊNCIA UV	RESISTENTE ÁGUA SALGADA	RESISTENTE QUÍMICOS	M M	CE
-----------------	------------------	-------------	---------------	------------	---------------------------	----------------	--------------------	-----------------------	--------------------------------	----------------------------	------------	-----------

Modelo	Ref.	Cor Color	Tensão Tensión	IP	Lumens /mt	Lumens /w
LARISSA	1314117.1030	3000K	24V	IP68	285Lm	28Lm
	1314117.1040	4000K	24V	IP68	272Lm	27Lm
	1314117.1060	6000K	24V	IP68	281Lm	28Lm
LARISSA RGB	1314117.10RGB	RGB	24V	IP68	R:36Nm G:130Nm B:24Nm	

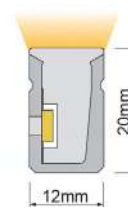
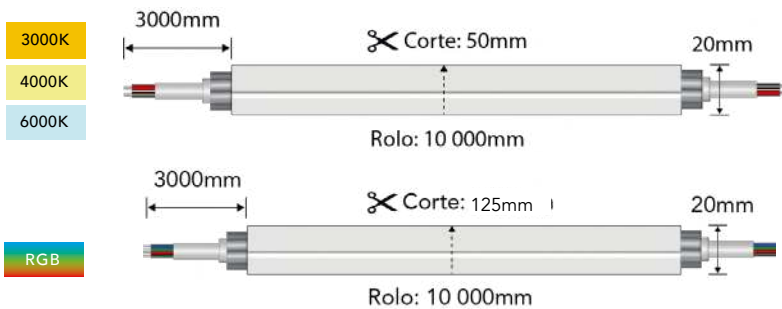

Este modelo standard tem saída de cabo de topo.
Este modelo estándar tiene una salida de cable superior.



ACESSÓRIOS RECOMENDADOS | ACCESORIOS RECOMENDADOS

Tampa final
Tapa final
Ref. 2214226



Calha fixadora flexível Inox 0,5mt
Perfil de fijación flexible de acero inoxidable 0,5mt
Ref. PF1511X



Personalização de cabo só é feita sob encomenda à fábrica.*
La personalización del cable solo se realiza mediante pedido de fábrica.*

Não inclui fixadores nem topos.
No incluye fijador ni tapas.

*Sujeito a confirmação de prazo de entrega. Sujeto a confirmación del tiempo de entrega.



NEON EXTRA LONG

Fitas Led / Tiras Led

NEON UP **NAMAKA** 10W IP67

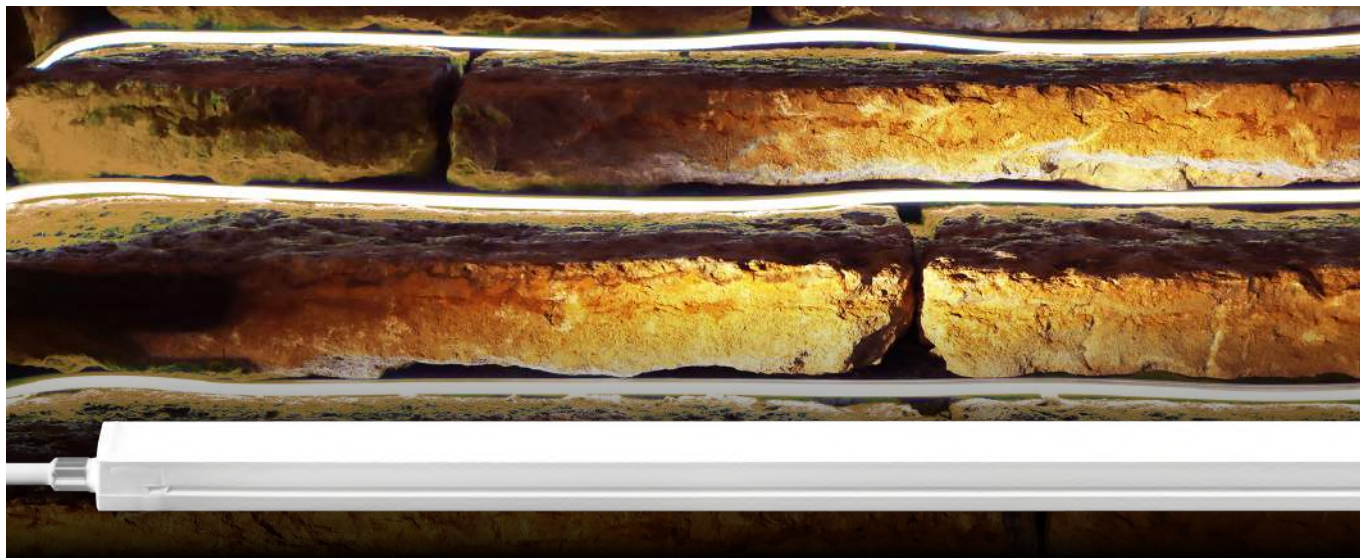

Modelo	Ref.	Cor Color	Tensão Tensión	IP	Lumens /mt	Lumens /w
NAMAKA L70B10 50000H 2 Steps MacAdam	132246.1027	2700K	24V	IP67	536Lm	54Lm
	132246.1030	3000K	24V	IP67	551Lm	55Lm
	132246.1040	4000K	24V	IP67	536Lm	54Lm

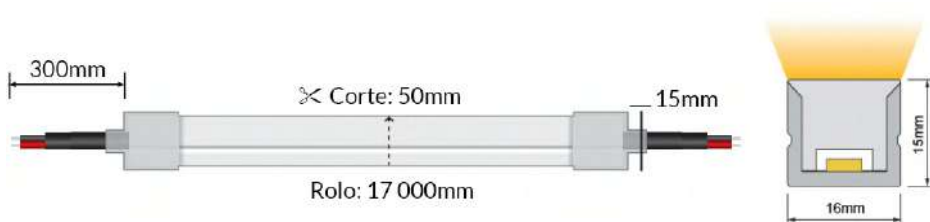

Este modelo standard tem saída de cabo de topo.
Este modelo estándar tiene una salida de cable superior.



ACESSÓRIOS RECOMENDADOS | ACCESORIOS RECOMENDADOS

Tampa final Tapa final Ref. 2219244	Tampa final Tapa final Ref. 2219253	Conector Ref. 2220244.RGB	Calha fixadora PL 1mt Perfil de fijación PL 1mt Ref. PF152PL	Calha fixadora AL 1mt Perfil de fijación AL 1mt Ref. PF152AL	Fixador 1615 Fijador 1615 Ref. 2226144

NEON UP NAMAKA IP67

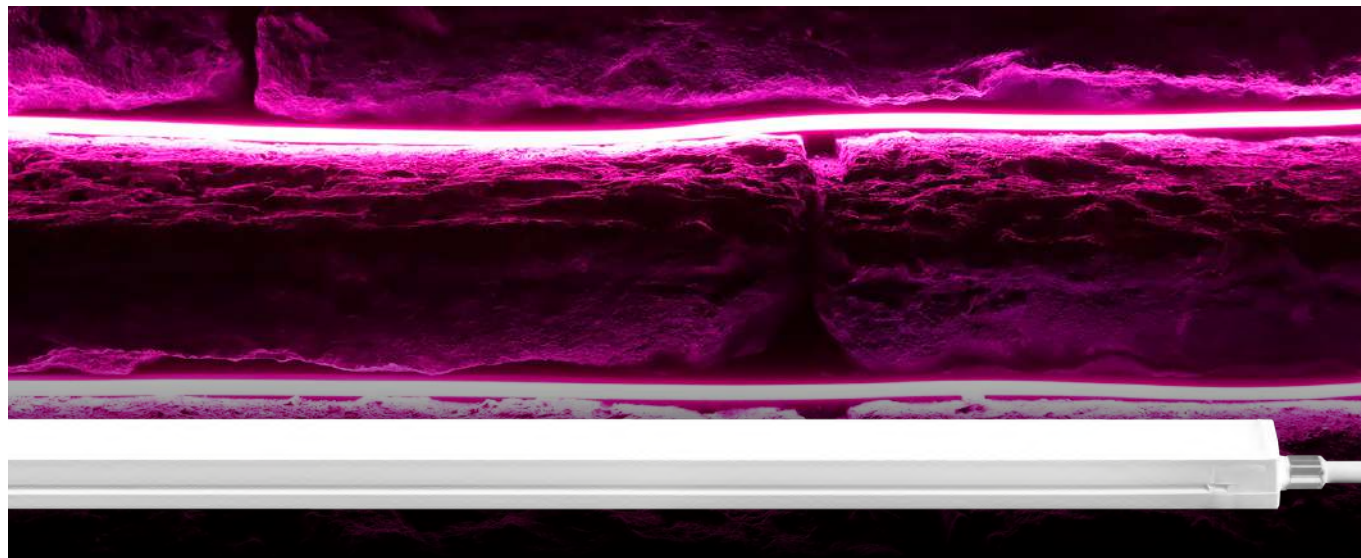

Modelo	Ref.	Cor Color	Tensão Tensión	IP	Numens /mt
NAMAKA L80 50000H 1Bin	136246.11RGB	RGB	24V	IP67	R: 625Nm G: 532Nm B: 475Nm
	1313116.15RGBWW	RGB + 3000K	24V	IP67	407Lm

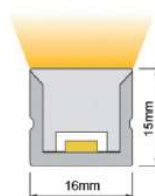
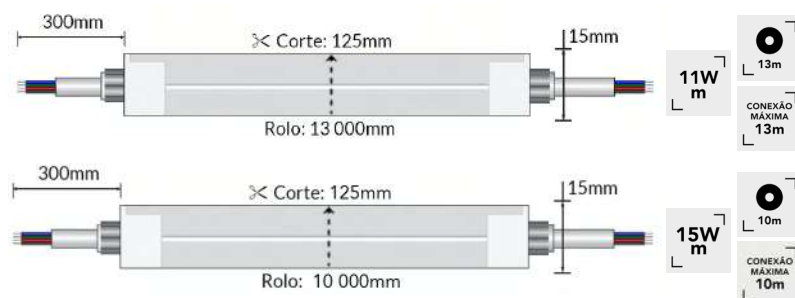

Este modelo standard tem saída de cabo de topo.
Este modelo estándar tiene una salida de cable superior.



ACESSÓRIOS RECOMENDADOS | ACCESORIOS RECOMENDADOS

Tampa final Tapa final Ref. 2219244	Tampa final Tapa final Ref. 2219253	Conector Ref. 2220244.RGB	Calha fixadora PL 1mt Perfil de fijación PL 1mt Ref. PF152PL	Calha fixadora AL 1mt Perfil de fijación AL 1mt Ref. PF152AL	Fixador 1615 Fijador 1615 Ref. 2226144

NEON UP AUTONOE 10W IP67



Modelo	Ref.	Cor Color	Tensão Tensión	IP	Lumens /mt	Lumens /w
AUTONOE L70B10 54000H	1324116.1027	2700K	24V	IP67	776Lm	78Lm
	1324116.1030	3000K	24V	IP67	797Lm	80Lm
	1324116.1040	4000K	24V	IP67	825Lm	83Lm
	1324116.10RGBWW	RGB + 3000K	24V	IP67	749Lm	50Lm

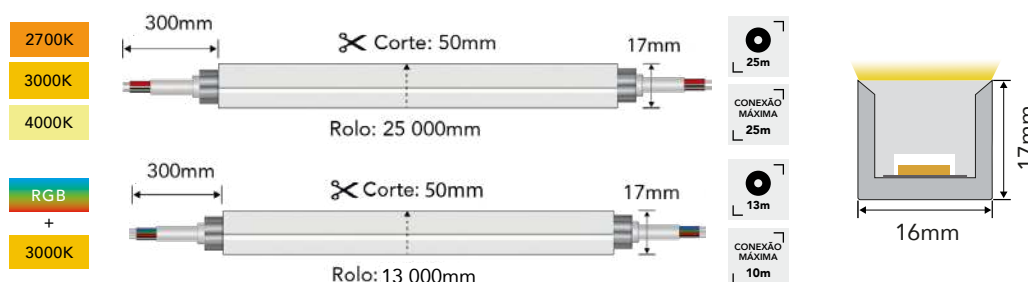

Este modelo standard tem saída de cabo de topo.
Este modelo estándar tiene una salida de cable superior.



ACESSÓRIOS RECOMENDADOS | ACCESORIOS RECOMENDADOS

<p>Calha Fixadora Perfil Fijación AL/PL 1mt AL Ref. PF190AL PL Ref. PF196PL</p>	<p>Calha Fixad. Flex. Perfil Fijación flex. AL 1mt / 2mt Ref. PF1890IX Ref. PF1890IX.2</p>	<p>Perfil Flexível Side Perfil Flexible Side Pavimento 1617 Ref. PF2290IX</p>	<p>Difusor Silicone Difusor Silicona Ref. DF2290SL</p>	<p>Perfil Flexível Enc. Perfil Flexible. Enc. c/ 2 Aba AL 2mt Ref. PF22901</p>	<p>Perfil Flexível Enc. Perfil Flexible. Enc. c/ 1 Aba AL 2mt Ref. PF23901</p>	<p>Fixador Fijador AL/PL 1617 AL Ref. 2226171 PL Ref. 2226272</p>

NEON UP C/ ABAS DEIMOS 10W IP44

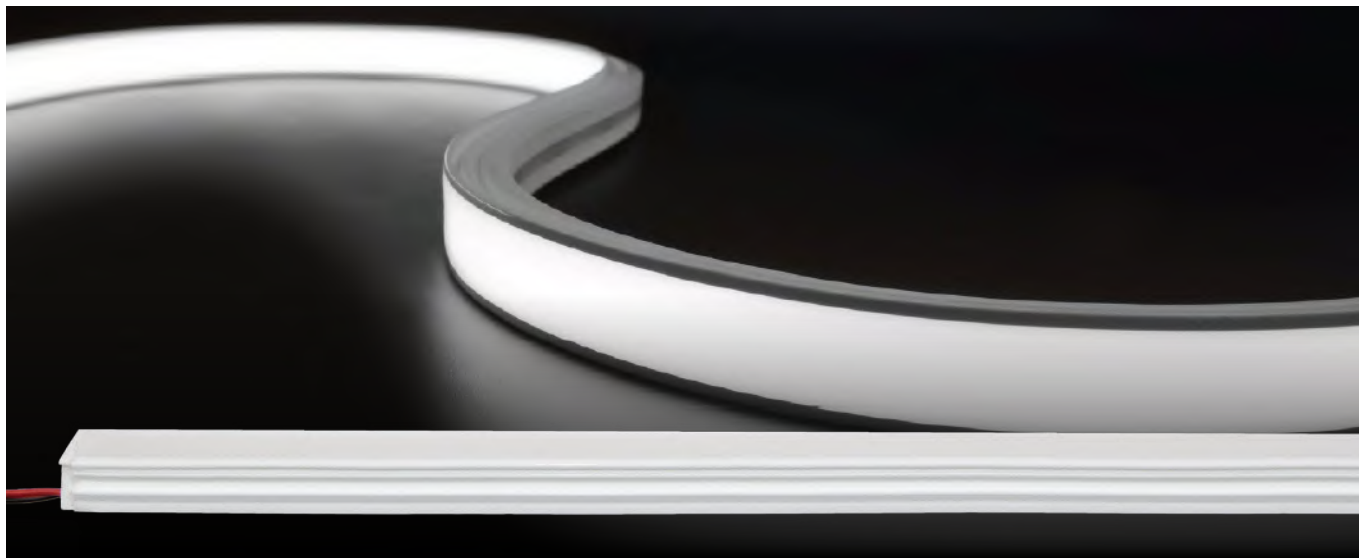

Modelo	Ref.	Cor Color	Tensão Tensión	IP	Lumens /mt	Lumens /w
DEIMOS 30000H	1332123.1027	2700K	24V	IP44	560Lm	56Lm
	1332123.1030	3000K	24V	IP44	607Lm	60,7Lm
	1332123.1040	4000K	24V	IP44	663Lm	66,3Lm

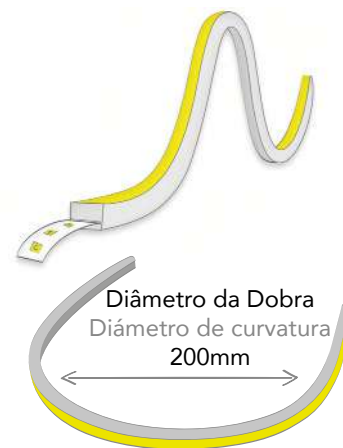

Este modelo standard tem saída de cabo de topo.
Este modelo estándar tiene una salida de cable superior.

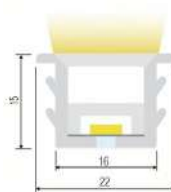
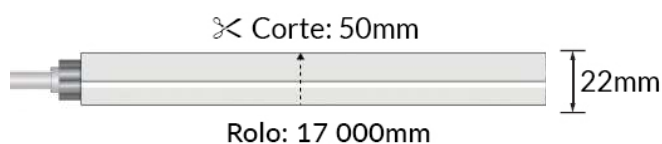

ACESSÓRIOS RECOMENDADOS | ACCESORIOS RECOMENDADOS

Calha fixadora PL 1mt
Perfil de fijación PL 1mt
Ref. PF152PL

Calha fixadora AL 1mt
Perfil de fijación AL 1mt
Ref. PF152AL

Fixador 1615
Fijador 1615
Ref. 2226144



NEON SIDE NÁIADE 10W IP67



Modelo	Ref.	Cor Color	Tensão Tensión	IP	Lumens /mt	Lumens /w
NÁIADE L70B10 54000H 2 Steps MacAdam	132256.1027	2700K	24V	IP67	324Lm	32Lm
	132256.1030	3000K	24V	IP67	346Lm	35Lm
	132256.1040	4000K	24V	IP67	346Lm	35Lm
NÁIADE L80 30000H 1BIN	136256.11RGB	RGB	24V	IP67	R: 625Nm G: 532Nm B: 475Nm	-

10W/m



11W/m

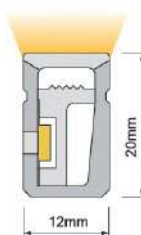
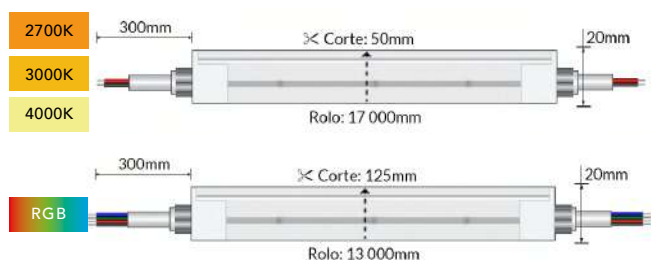

Este modelo standard tem saída de cabo de topo.
Este modelo estándar tiene una salida de cable superior.

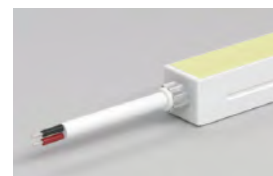

ACESSÓRIOS RECOMENDADOS | ACCESORIOS RECOMENDADOS

Tampa final Tapa final Ref. 2219247	Tampa final Tapa final Ref. 2214226	Conector Ref. 2220247	Calha fixadora Perfil de fijación AL 1mt Ref. PF151AL	Fixador 1220 Fijador 1220 Ref. 2226147	Calha fixadora flexível inox Perfil de fijación flexible de acero inoxidable Ref. PF151IX - 0,5mt Ref. PF151IX.1 - 1mt

NEON SIDE C/ ABAS TALASSA 10W IP44

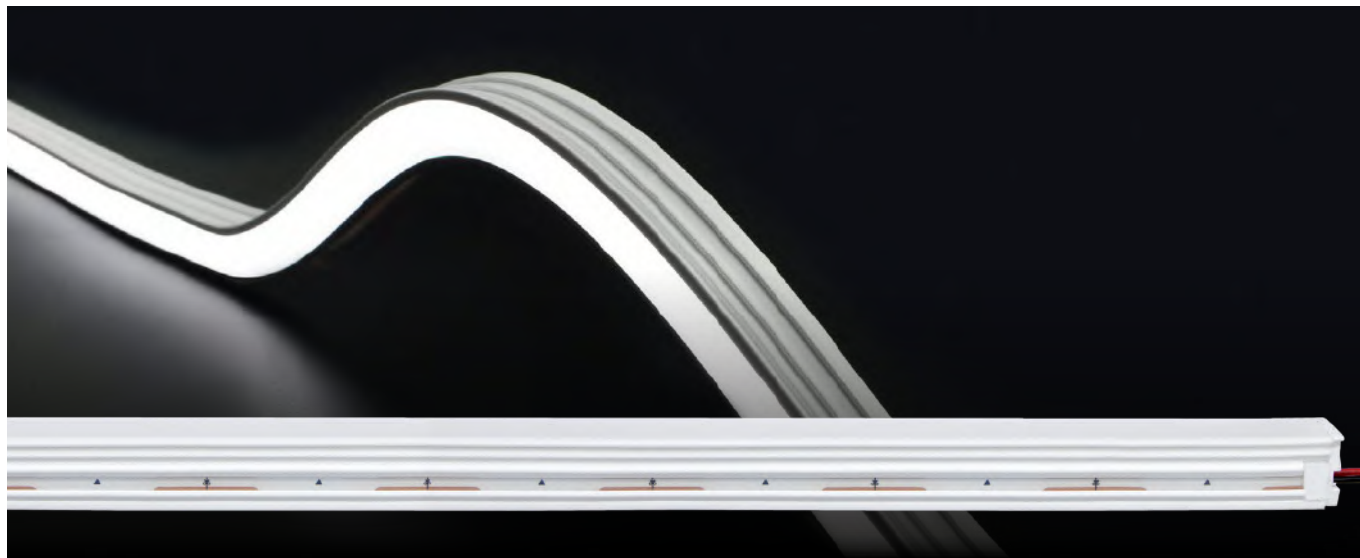

Modelo	Ref.	Cor Color	Tensão Tensión	IP	Lumens /mt	Lumens /w
	1336123.1027	2700K	24V	IP44	365Lm	36,5Lm
TALASSA 30000H	1336123.1030	3000K	24V	IP44	370Lm	37Lm
	1336123.1040	4000K	24V	IP44	407Lm	40,7Lm



Este modelo standard tem saída de cabo de topo.
Este modelo estándar tiene una salida de cable superior.

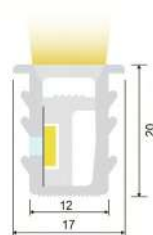
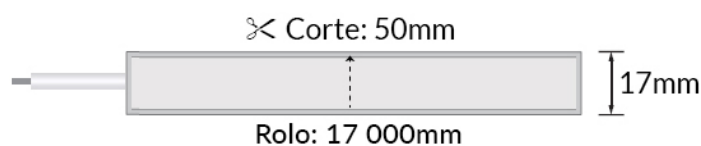

ACESSÓRIOS RECOMENDADOS | ACCESORIOS RECOMENDADOS

Calha fixadora
Perfil de fijación
AL 1mt
Ref. PF151AL

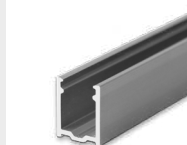

Fixador 1220
Fijador 1220
Ref. 2226147



Calha fixadora flexível inox mt
Perfil de fijación flexible de acero inoxidable mt
Ref. PF151IX - 0,5mt
Ref. PF151IX.1 - 1mt



NEON SIDE ESPONDE 10W IP67

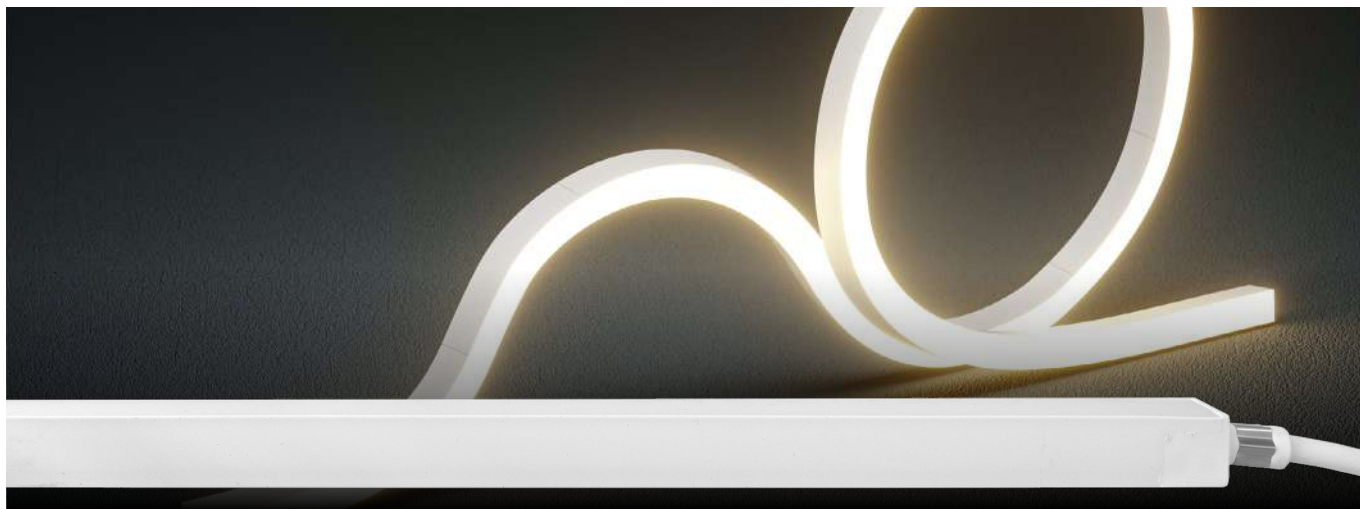

Modelo	Ref.	Cor Color	Tensão Tensión	IP	Lumens /mt	Lumens /w
ESPONDE L70B10 54000H	1325116.1027	2700K	24V	IP67	528Lm	53Lm
	1325116.1030	3000K	24V	IP67	555Lm	56Lm
	1325116.1040	4000K	24V	IP67	591Lm	59Lm
	1325116.10RGBWW	RGB + 3000K	24V	IP67	644Lm	43Lm

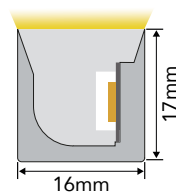
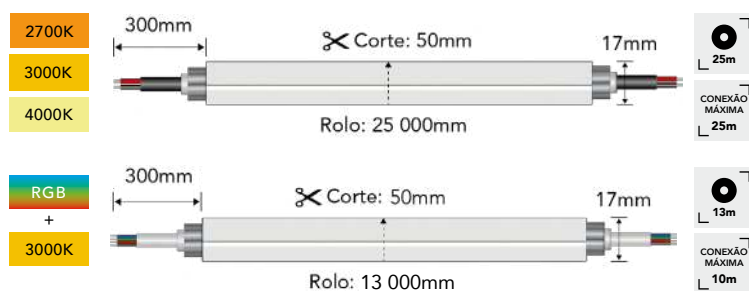
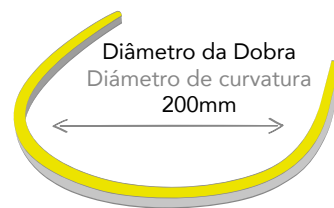

Este modelo standard tem saída de cabo de topo. Este modelo estándar tiene una salida de cable superior.



ACESSÓRIOS RECOMENDADOS | ACCESORIOS RECOMENDADOS

<p>Calha Fixadora Perfil Fijación AL/PL 1mt AL Ref. PF190AL PL Ref. PF196PL</p>	<p>Calha Fixad. Flex. Perfil Fijación flex. AL 1mt / 2mt Ref. PF1890IX Ref. PF1890IX.2</p>	<p>Perfil Flexível Side Perfil Flexible Side Pavimento 1617 Ref. PF2290IX</p>	<p>Difusor Silicone Difusor Silicona Ref. DF2290SL</p>	<p>Perfil Flexível Enc. Perfil Flexible. Enc. c/ 2 Aba AL 2mt Ref. PF22901</p>	<p>Perfil Flexível Enc. Perfil Flexible. Enc. c/ 1 Aba AL 2mt Ref. PF23901</p>	<p>Fixador Fijador AL/PL 1617 AL Ref. 2226171 PL Ref. 2226272</p>

ARTIGO EM DESTAQUE

PERFIL FLEXÍVEL DE NEONS PARA PAVIMENTO EXTERIOR



Perfil Flexível para Pavimento Neon Side

Perfil flexível para pavimento para soluções de Neon Side de dimensões 16x17mm

Perfil flexible para pavimento para soluciones Neon Side de dimensiones 16x17mm



Perfil Flexível | Perfil Flexible

Ref. PF2290IX

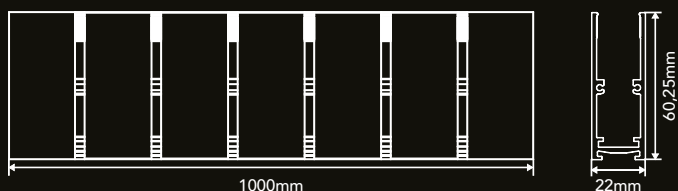

Difusor de Silicone | Difusor de Silicona

Ref. DF2290SL

Rolo Máx.: 30m

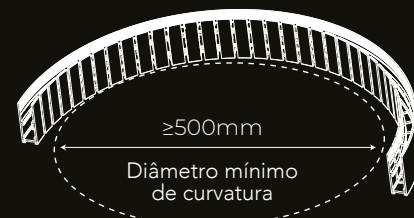
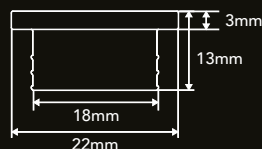

SOLUÇÃO PARA ENCASTRE NO PAVIMENTO COM:

Fita Led Neon Autonoe
Ref. 1324116.10XX

Fita Led Neon Esponde
Ref. 1325116.10XX





NEONS 230V

Neón 230V

NEON UP LARIMAR 230V 12W IP67



Modelo	Ref.	Cor Color	Tensão Tensión	IP	Lumens /mt	Lumens /w
LARIMAR 50000H	1342116.1227	2700K	230V	IP67	644Lm	54Lm
	1342116.1230	3000K	230V	IP67	665Lm	55Lm
	1342116.1240	4000K	230V	IP67	684Lm	57Lm

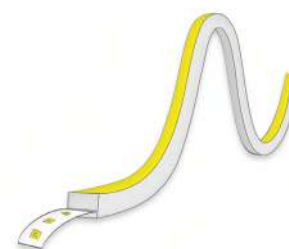

Diâmetro da Dobra
Diámetro de curvatura
200mm

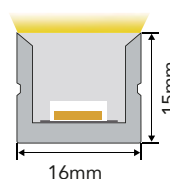
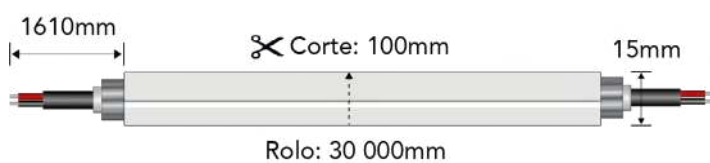

Este modelo standard tem saída de cabo de topo.
Este modelo estándar tiene una salida de cable superior.



ACESSÓRIOS RECOMENDADOS | ACCESORIOS RECOMENDADOS

Tampa final Tapa final Ref. 2219244	Tampa final Tapa final Ref. 2219253	Conector Ref. 2220244	Calha fixadora PL 1mt Perfil de fijación PL 1mt Ref. PF152PL	Calha fixadora AL 1mt Perfil de fijación AL 1mt Ref. PF152AL	Fixador 1615 Fijador 1615 Ref. 2226144

NEON SIDE MALÍ 230V 12W IP67



Modelo	Ref.	Cor Color	Tensão Tensión	IP	Lumens /mt	Lumens /w
MALÍ 50000H	1343116.1227	2700K	230V	IP67	487Lm	41Lm
	1343116.1230	3000K	230V	IP67	503Lm	42Lm
	1343116.1240	4000K	230V	IP67	519Lm	43Lm

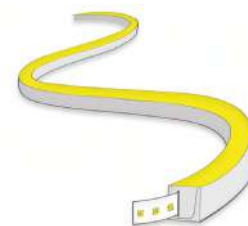

Diâmetro da Dobra
Diâmetro de curvatura
150mm

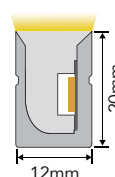
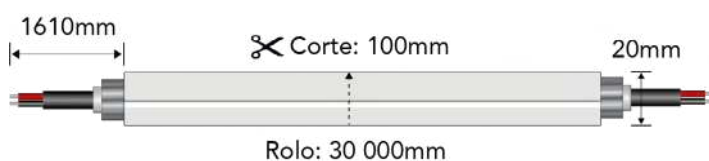

Este modelo standard tem saída de cabo de topo.
Este modelo estándar tiene una salida de cable superior.



ACESSÓRIOS RECOMENDADOS | ACCESORIOS RECOMENDADOS

<p>Tampa final Tapa final Ref. 2219247</p> 	<p>Tampa final Tapa final Ref. 2214226</p> 	<p>Conector Ref. 2220247</p> 	<p>Calha fixadora Perfil de fijación AL 1mt Ref. PF151AL</p> 	<p>Calha fixadora flex.Inox Perfil de fijación flex. inox Ref. PF151IX 0,5mt Ref. PF151IX.1 - 1mt</p> 	<p>Fixador 1220 Fijador 1220 Ref. 2226147</p> 
--	--	--	---	---	---





TUBO NEON

Neón Tubo

NEON TUBO - UP IP67

NEÓN TUBO - UP

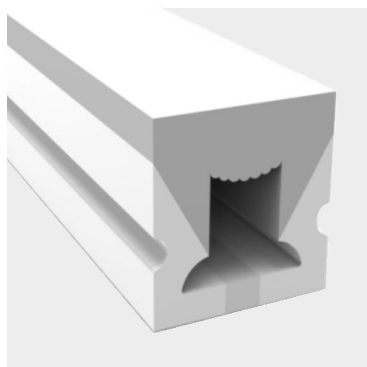

Ref. NT2.1010



_Tubo Neon com iluminação vertical e horizontal.
_Para fitas até 6mm, máximo de 15W/mt.

_Tubo de neón con iluminación vertical y horizontal.
_Para tiras hasta 6mm, max 15W/mt.

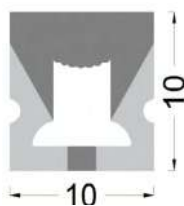

Topo com passagem de fio
Tampa con paso de cable
Ref. TPF2.1010



Topo sem passagem de fio
Tampa sin paso de cable
Ref. TP2.1010



Fixador
Fijador
Ref. FX2.1010

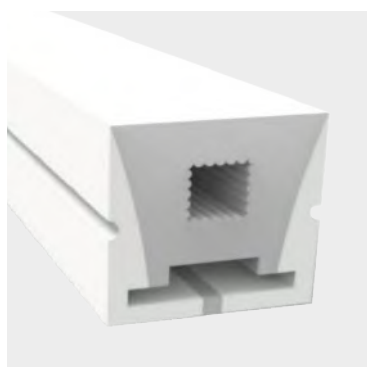

Ref. NT1.1616



_Tubo Neon com iluminação vertical
_Para fitas de 10 a 12mm, máximo de 15W/mt.

_Tubo de neón con iluminación vertical.
_Para tiras de 10 a 12 mm, máximo de 15W/mt.

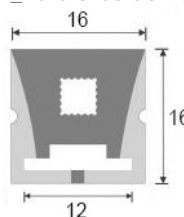

Topo com passagem de fio
Tampa con paso de cable
Ref. TPF1.1616



Topo sem passagem de fio
Tampa sin paso de cable
Ref. TP1.1616



Fixador
Fijador
Ref. FX1.1616



NEON TUBO - SIDE IP67

NEÓN TUBO - SIDE

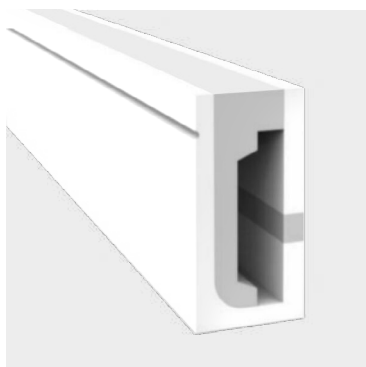

Ref. NT3.612

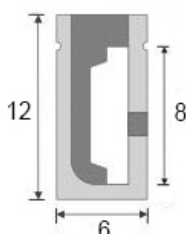

_Tubo Neon com iluminação horizontal.
_Para fitas até 8mm, máximo de 15W/mt.

_Tubo de neón con iluminación horizontal.
_Para tiras hasta 8mm, max 15W/mt.

Topo com passagem de fio
Tampa con paso de cable
Ref. TPF3.612

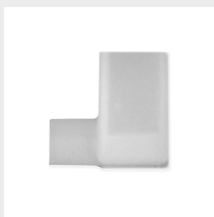

Topo sem passagem de fio
Tampa sin paso de cable
Ref. TP3.612



Fixador
Fijador
Ref. FX3.612



Ref. NT3.1220

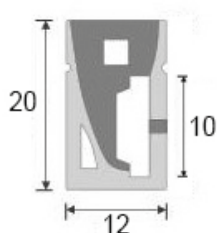

_Tubo Neon com iluminação horizontal.
_Para fitas até 10mm, máximo de 15W/mt.

_Tubo de neón con iluminación horizontal.
_Para tiras hasta 10mm, max 15W/mt.

Topo com passagem de fio
Tampa con paso de cable
Ref. TPF3.1220



Topo sem passagem de fio
Tampa sin paso de cable
Ref. TP3.1220



Fixador
Fijador
Ref. FX3.1220



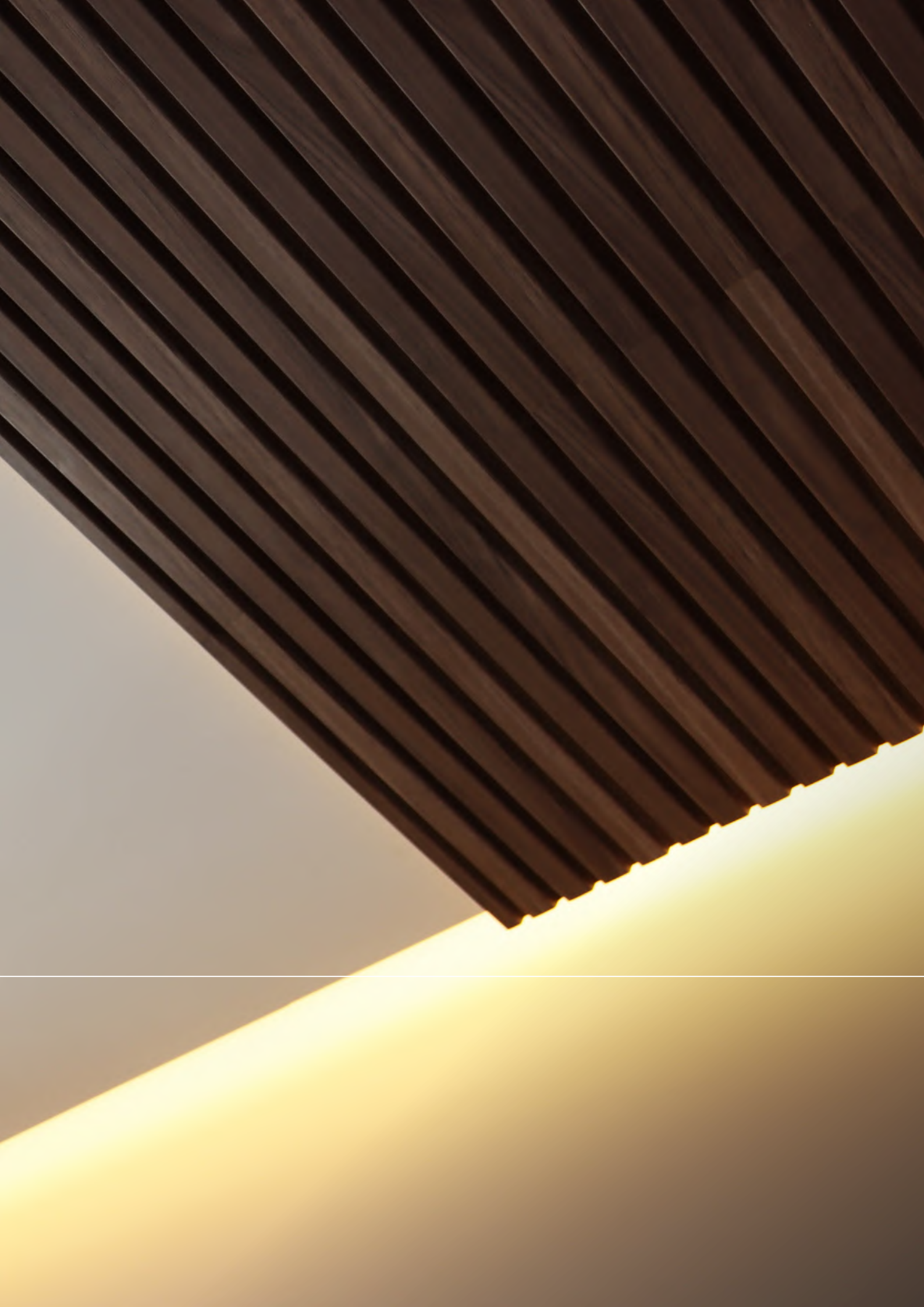

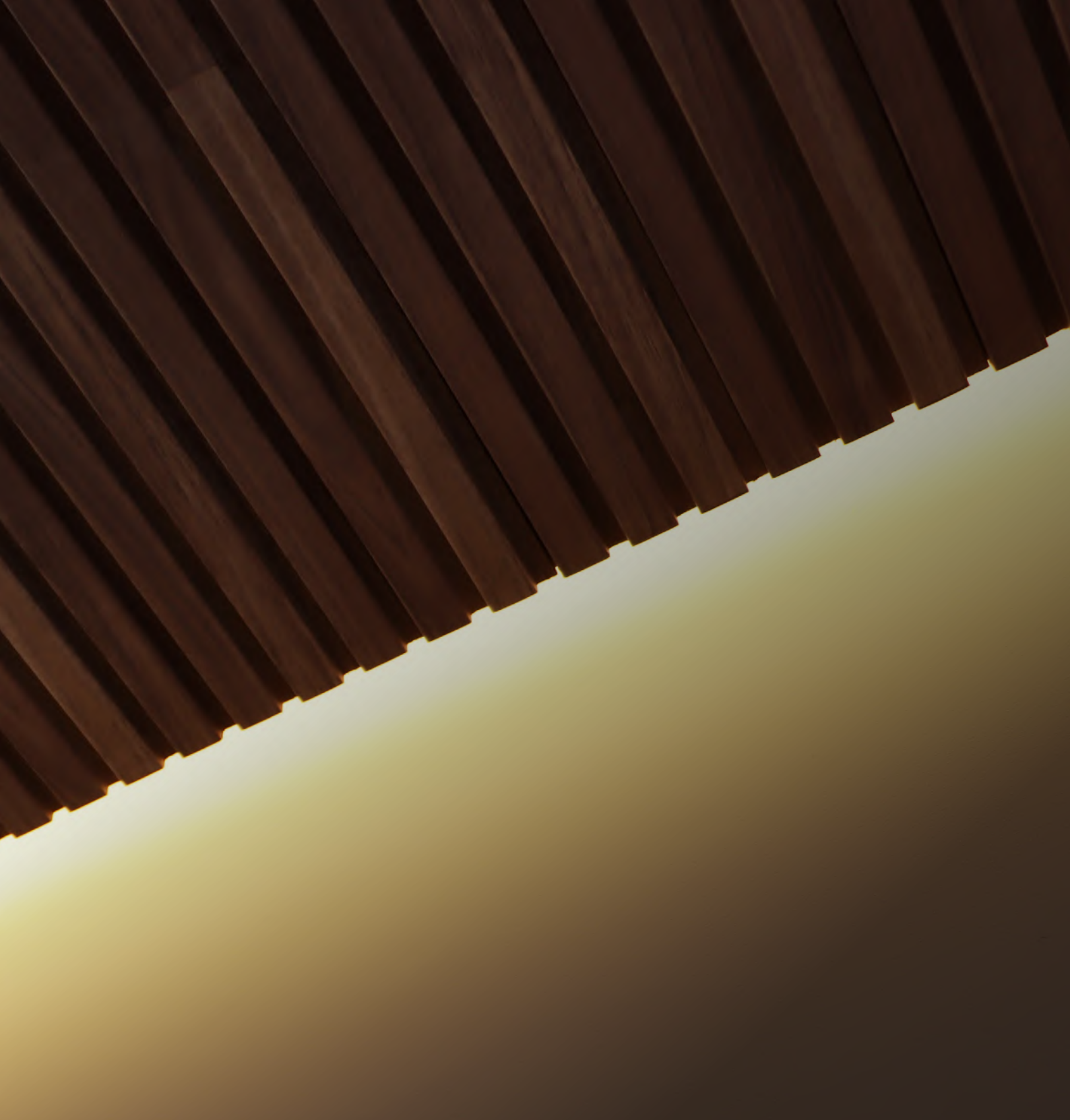

FITAS LED

Tiras Led

FITA LED

TIRA LED



LED LIGHT EMITTING DIODE

O led é um díodo emissor de luz, ou seja, é um componente eletrónico que, polarizado através da condução de corrente elétrica num sentido, emite luz.

A cor de luz emitida pelo led é determinada pelos componentes químicos internos inseridos, emitindo assim as diferentes temperaturas de cor na escala de Kelvin, o RGB, infravermelhos e ultravioletas.

Os leds não se gastam e aquecem muito pouco. Acendem e apagam instantaneamente sem perder vida útil e têm uma média de vida bastante longa de aproximadamente 50.000 horas de vida.

Resiste a pequenos impactos, pois o LED é um estado sólido. É uma "placa de silício". Como o aquecimento é baixo, o envelhecimento dos outros materiais adjacentes como difusores, cablagens e suportes, também é mais lento.

El LED es un diodo emisor de luz, es decir, es un componente electrónico que al polarizarse mediante la conducción de corriente eléctrica en una dirección, emite luz.

El Color de la luz emitida por el LED está determinado por los componentes químicos internos insertados, emitiendo así las diferentes temperaturas de Color en la escala Kelvin, la RGB, la infrarroja y la ultravioleta.

Los LED no se desgastan y se calientan muy poco. Se encienden y apagan al instante sin perder vida y tienen una vida media muy larga de aproximadamente 50.000 horas de vida.

Resiste pequeños impactos ya que el LED es de estado sólido. Es una "placa de silicona". Como el calentamiento es bajo, el envejecimiento de otros materiales adyacentes como difusores, cableado y soportes también es más lento.

IP GRAU DE PROTEÇÃO

GRADO DE PROTECCIÓN

A sigla IP é um padrão internacional, norma IEC 60529 que representa o grau de proteção de uma luminária.

O primeiro dígito do valor IP indica o nível de proteção que a luminária tem perante componentes sólidos externos. O segundo dígito do IP indica o nível de proteção que a luminária tem face à sua submersão em água.

El acrónimo IP es un estándar internacional, norma IEC 60529 que representa el grado de protección de una luminaria.

El primer dígito del valor IP indica el nivel de protección que tiene la luminaria frente a componentes sólidos externos. El segundo dígito del IP indica el nivel de protección que tiene la luminaria frente a su inmersión en agua.



1º ALGARISMO | 1º DÍGITO

Proteção contra objetos
Protección contra objetos

2º ALGARISMO | 2º DÍGITO

Proteção contra água
Protección del agua



Proteção contra objetos sólidos e sem proteção à água.

Protección contra objetos sólidos y sin protección contra el agua.



Proteção contra poeira e salpicos de água.

Protección contra polvo y salpicas de agua.



À prova de poeira e proteção contra jatos de água.

Protección contra el polvo y los chorros de agua.

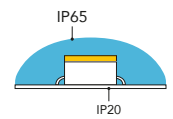

À prova de poeira e proteção contra a imersão temporária em água de até 1 metro por 30 minutos.

A prueba de polvo y protección contra inmersión temporal en agua hasta 1 metro durante 30 minutos.



À prova de poeira e proteção contra a imersão contínua em água.

A prueba de polvo y protección contra inmersión continua en agua.



FITA LED | TIRA LED

VIDA ÚTIL DO LED

VIDA ÚTIL DE LOS LED

EXEMPLO | EJEMPLO

L70B10

L70 B10

L70B10 significa que 10% (valor do B) dos módulos LED estão abaixo de 70% (valor do L) do fluxo luminoso inicial e respetivamente 90% estará acima de 70% do valor inicial.

70B10 significa que el 10 % (valor B) de los módulos LED está por debajo del 70 % (valor L) del flujo luminoso inicial y, respectivamente, el 90 % estará por encima del 70 % del valor inicial.

FATORES QUE INFLUENCIAM A VIDA DO LED

- _ Temperatura da aplicação do LED;
- _ Montagem e manuseamento;
- _ Intensidade e luminosidade emitida pelo chip;
- _ Proteção contra humidade;
- _ Aplicação em ambientes químicos e/ou corrosivos.

A vida útil de uma luminária representa o número de horas que decorre quando se atinge uma percentagem mínima aceitável do fluxo de luz inicial.

O fluxo luminoso de um LED diminui ao longo do seu tempo de vida. Esta degradação é caracterizada pelo valor L.

A vida útil de um LED está relacionada com a depreciação do fluxo luminoso a uma determinada temperatura ambiente.

O valor mínimo de luminosidade de uma luminária é de 70% do valor inicial (L70) para 50.000 horas de vida.

FACTORES QUE INFLUYEN EN LA VIDA DEL LED

- _ Temperatura de aplicación del LED;
- _ Montaje y manipulación;
- _ Intensidad y luminosidad emitida por el chip;
- _ Protección contra la humedad;
- _ Aplicación en ambientes químicos y/o corrosivos.

La vida útil de una luminaria representa el número de horas que se decolora cuando se alcanza un porcentaje mínimo aceptable del flujo de luz inicial.

El flujo luminoso de un LED disminuye a lo largo de su vida útil. Esta degradación se caracteriza por el valor L.

La vida útil de un LED está relacionada con la depreciación del flujo luminoso a una temperatura ambiente determinada.

El valor mínimo de luminosidad de una luminaria es el 70% del valor inicial (L70) para 50.000 horas de vida.

A ETIQUETA ENERGÉTICA LA ETIQUETA ENERGÉTICA



ESCALA ENERGÉTICA

Nova escala energética de A a G. Deixa de haver classes "+". As classes inferiores poderão vir a ser suprimidas à medida que os produtos menos eficientes desapareçam do mercado.

ESCALA DE ENERGÍA

Nueva escala de energía de la A a la G. Ya no hay clases "+". Las clases más bajas pueden ser suprimidas a medida que los productos menos eficientes desaparezcan del mercado.

CONSUMO

Consumo de eletricidade em kWh por 1000 horas de utilização.

Consumo de electricidad en kWh por 1000 horas de uso.



A classes energéticas de A+++ a D tornaram-se ineficazes na distinção de produtos energeticamente mais eficientes uma vez que grande parte dos produtos no mercado se encontra já nas classes energéticas superiores. Assim, torna-se difícil para os consumidores distinguir quais os produtos mais eficientes.

Visando tornar mais clara a informação disponível na etiqueta energética, a União Europeia reviu e otimizou a etiqueta de acordo com as necessidades do consumidor. A nova etiqueta apresentará uma escala de classe energética entre A e G.

Las clases de energía de A+++ a D se han vuelto ineficaces para distinguir productos más eficientes desde el punto de vista energético, ya que la mayoría de los productos en el mercado ya se encuentran en las clases de energía más altas. Por lo tanto, se vuelve difícil para los consumidores distinguir qué productos son más eficientes.

Para que la información disponible en la etiqueta energética sea más clara, la Unión Europea ha revisado y optimizado la etiqueta a color para satisfacer las necesidades de los consumidores. La nueva etiqueta contará con una escala de clase energética entre A y G.

MODO DE INSTALAÇÃO DE FITA LED

MÉTODO DE INSTALACIÓN DE TIRAS LED



As fitas de LED são produtos de baixa voltagem e por isso tem de usar uma fonte de alimentação. Não ligue diretamente uma fita de LED a uma corrente de 110 ou 230v, caso contrário queimará as fitas de LED.

Aconselhamos a aplicação de um perfil de forma a dissipar o calor emitido pela fita.

As fitas fornecidas em rolos de 5m não deverão ser ligadas em troços superiores a 5m e, sempre que for possível, deverá ser feita a ligação nas duas extremidades da fita.

As fitas fornecidas em rolos de 10m e 20m não deverão ser ligadas em troços superiores a 20m. No caso das fitas fornecidas em rolos de 50m, estas deverão ser alimentadas nas duas extremidades.

Certifique-se que a superfície onde irá instalar a fita está bem limpa para garantir a eficácia do adesivo.

Las tiras LED son productos de bajo voltaje y por lo tanto debes utilizar una fuente de alimentación. No conecte directamente una tira de LED a una corriente de 110 o 230v, de lo contrario quemará las tiras de LED.

Aconsejamos la aplicación de un perfil para disipar el calor emitido por la tira.

Las tiras suministradas en rollos de 5m no deben conectarse en tramos de más de 5m y, siempre que sea posible, la conexión debe realizarse en ambos extremos de la tira.

Las tiras suministradas en rollos de 10m y 20m no deben conectarse en tramos de más de 20m. En el caso de tiras que se suministren en rollos de 50m, deberán ser alimentadas por ambos extremos. Asegúrate de que la superficie donde instalarás la tira esté muy limpia para asegurar la efectividad del adhesivo.

Quando instalar a fita de LED tenha em atenção alguns procedimentos. Pode moldar a fita mas não a deve dobrar/vincar, conforme pode confirmar nas imagens abaixo.

Al instalar la tira de LED, preste atención a ciertos procedimientos. Puedes darle forma a la tira pero no debes doblarla/arrugarla, como puedes comprobar en las siguientes imágenes.



MOLDAR A FITA CORRETAMENTE USANDO LA TIRA CORRECTAMENTE



Se precisar de moldar a fita faça-o deixando sempre um raio superior a 50mm.

Si necesita dar forma a la tira, hágalo siempre dejando un radio superior a 50 mm.

POR UM FUTURO MAIS SUSTENTÁVEL



A MOTAKO está focada na sustentabilidade ambiental. Para isso apresenta as suas **novas embalagens e bobines em cartão, agora mais ecológicas.**

MOTAKO se centra en la sostenibilidad medioambiental. Para ello presenta sus **nuevos embalajes y bobinas de cartón, ahora más ecológicos.**























– Embalagens com novo design, agora em cartão, para reduzir o nosso impacto no futuro do planeta.

– **Uma nova imagem, com os produtos e qualidade de sempre**







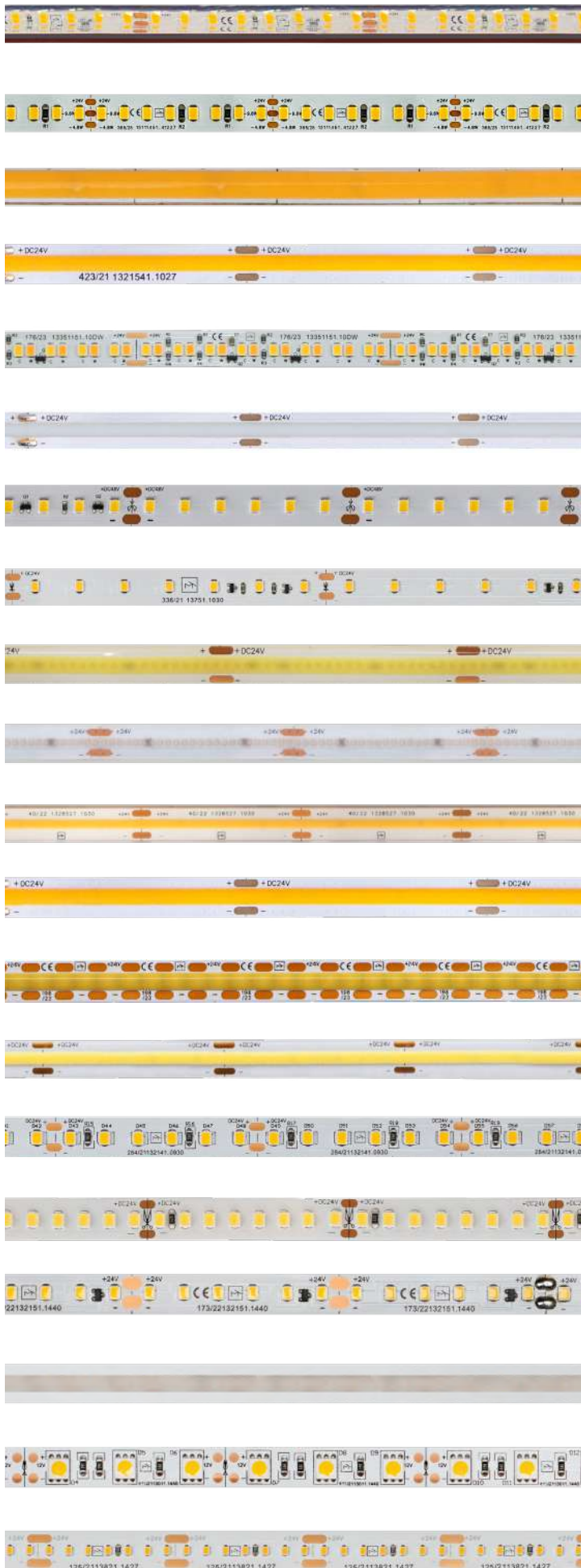



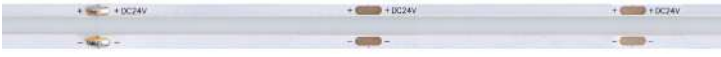







– Envases de nuevo diseño, ahora en cartón, para reducir nuestro impacto en el futuro del planeta.

– **Una nueva imagen, con los mismos productos y calidad de siempre.**

AMALTEIA IP20 IP65	4,8W/mt	Pág. 142	
PUCK IP20	5W/mt	Pág. 143	
SAFIRA IP20	6,3W/mt	Pág. 144	
PÃ IP20	7W/mt	Pág. 145	
FRANCISCO IP20 IP68	7W/mt	Pág. 146	
KARI IP20	7,2W/mt	Pág. 147	
SURTUR IP20	7,2W/mt	Pág. 148	
SURTUR IP65	7,2W/mt	Pág. 149	
JULIETA IP20 IP65	7,2W/mt	Pág. 150	
MAB IP20	9W/mt	Pág. 151	
ZIG ZAG IP20 Flexível	9,6W/mt	Pág. 152	
HIGH ZIG ZAG IP20 Flexível	10W/mt	Pág. 153	
ZIG ZAG PLUS IP20 Flexível	19,2W/mt	Pág. 154	
HIGH DUAL ZIG ZAG IP20 Flexível	14,4W/mt	Pág. 155	
ELARA/ HIGH ELARA IP20	9,6W/mt	Pág. 156	
ELARA 65/ ELARA 67 IP65 IP67	9,6W/mt	Pág. 157	
MIMAS IP20	9,6W/mt	Pág. 158	
REIA IP20	9,6W/mt	Pág. 159	
LOW OBERON IP67	9,6W/mt	Pág. 160	
CALISTO IP65	9,6W/mt	Pág. 161	



Pág. 162	9,6W/mt	TEBE IP67
Pág. 163	4,8/9,6 12,5W/mt	MULTIPOWER IP20
Pág. 165	10W/mt	COB CALE IP20
Pág. 166	10W/mt	COB CARPO IP20
Pág. 167	10W/mt	MEGACLITE IP20
Pág. 168	10W/mt	CSP TEMISTO IP20
Pág. 169	10W/mt	HERMIPE IP20 IP67
Pág. 170	10W/mt	ARIEL IP20 IP68
Pág. 171	10W/mt	COB HATI IP54
Pág. 172	10W/mt	EUPORIA IP68
Pág. 174	10W/mt	COB TITÂNIA IP68
Pág. 175	10W/mt	CRISTAL IP20 IP68
Pág. 176	11W/mt	COB E SOB CILENE IP20 Corte Livre
Pág. 177	11W/mt	TURQUESA IP20
Pág. 178	12W/mt	FULL SPECTRUM IP20
Pág. 179 a 183	12W e 9,6W/mt	EUROPA E NOVA EUROPA IP20 IP65 IP68
Pág. 184	14,4W/mt	FOBOS IP20
Pág. 185	14,4W/mt	DIFUSA OBERON IP67
Pág. 186	14,4W/mt	LUA IP20 IP65
Pág. 187	14,4W/mt	PERDITA IP20

PROSPERO IP20	14,4W/mt	Pág. 188	
CSP E SOB TARVOS IP20	14,4W/mt	Pág. 190	
GALATEIA IP20	14,4W/mt	Pág. 191	
MIRANDA IP20	14,4W/mt	Pág. 192	
MARGARET IP20 IP65 IP68	14,4W/mt	Pág. 193	
HELENE IP20 IP68	14,4W/mt	Pág. 194	
DIONE IP20 IP67	14,4W/mt	Pág. 195	
HIMALIA IP67	14,4W/mt	Pág. 196	
AEGIR IP68	14,4W/mt	Pág. 197	
TITÃ IP20	15W/mt	Pág. 198	
CUPIDO IP20	15W/mt	Pág. 199	
PROTEU IP20	15W/mt	Pág. 200	
POLIDEUCES E NOVA POLIDEUCES IP20 IP54 IP65	15W/mt	Pág. 201 a 203	
CRÉSSIDA IP20 IP54	15W/mt	Pág. 204	
COB E CSP CALIQUE IP20	15W/mt	Pág. 205	
ORTÓSIAS 230V IP65	15W/mt	Pág. 206	
COB CALICORE IP65	15W/mt	Pág. 207	
HIGH CORÉ IP20	16W/mt	Pág. 208	
COB CORDÉLIA IP20	18W/mt	Pág. 209	
CALIPSO IP20 IP65	18W/mt	Pág. 210	



Pág. 211 **18W/mt** **BELINDA**
IP20



Pág. 212 **18W/mt** **FERDINAND**
IP20 | IP65



Pág. 213 **19W/mt** **STEPHANO**
IP20



Pág. 214 **19,2W/mt** **PSÁMATA**
IP67



Pág. 215 **19,2W/mt** **CCT LEDA2F**
IP20



Pág. 216 **19,3W/mt** **CCT LEDA**
IP20 | IP67



Pág. 217 **20W/mt** **COB CCT LISITEIA**
IP20



Pág. 218 **20W/mt** **CSP CCT LISITEIA**
IP20



Pág. 219 **20W/mt** **PRAVIDIQUE**
IP20



Pág. 220 **24W/mt** **OFÉLIA**
IP20



Pág. 221 **26W/mt** **TIONE**
IP20



Pág. 222 **34W/mt** **CARONTE**
IP20



Pág. 223 **40W/mt** **PANDORA**
IP20



Pág. 246 **14,4W/mt** **DIGITAL MAGIC**
IP20



Pág. 247 **18W/mt** **DIGITAL RGB**
IP20



Pág. 248 **18W/mt** **COB DIGITAL RGB**
IP20



Pág. 249 **12W/mt** **COB DIGITAL 3000K**
IP20



Pág. 250 **18W/mt** **DIGITAL**
IP20



Pág. 251 **12W/mt** **LED NEON DIGITAL TALASSA**
IP44

AMALTEIA 4,8W IP20 | IP65

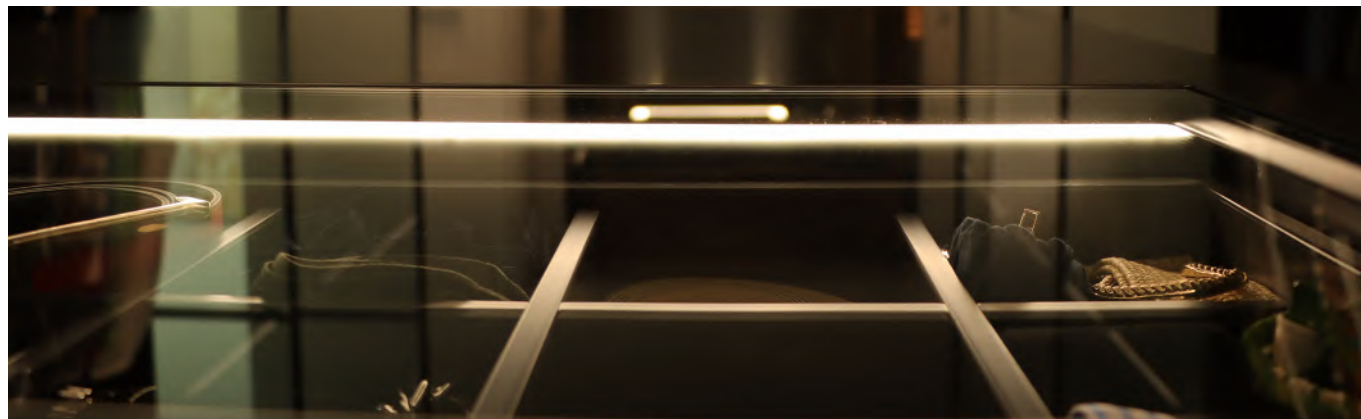

IP20 IP65

8 mm 4,8W/m IP20 IP65 20Z 2835 SMD 60 LED/m 5m CONEXÃO MÁXIMA 5m DIMÁVEL CRI 80 120° M M CE

Modelo	Ref.	Efic.	Cor Color	Tensão Tensión	IP	Lumens /mt	Lumens /w
AMALTEIA L70B50 36000H 3 Steps MacAdam	130111.0427	G	2700K	12V	IP20	430Lm	90Lm
	130111.0430	G	3000K	12V	IP20	440Lm	92Lm
	130111.0440	F	4000K	12V	IP20	450Lm	94Lm
	130111.0460	F	6000K	12V	IP20	450Lm	94Lm
	130141.0427	G	2700K	24V	IP20	430Lm	90Lm
	130141.0430	G	3000K	24V	IP20	440Lm	92Lm
	130141.0440	F	4000K	24V	IP20	500Lm	104Lm
	130141.0460	F	6000K	24V	IP20	450Lm	94Lm
AMALTEIA 65 L70B50 50000H	130115.0427	F	2700K	12V	IP65	455Lm	95Lm
	130115.0430	F	3000K	12V	IP65	455Lm	95Lm
	130115.0440	F	4000K	12V	IP65	494Lm	103Lm
	130115.0460	F	6000K	12V	IP65	494Lm	103Lm
	130145.0427	F	2700K	24V	IP65	455Lm	95Lm
	130145.0430	F	3000K	24V	IP65	455Lm	95Lm
	130145.0440	F	4000K	24V	IP65	494Lm	103Lm
	130145.0460	F	6000K	24V	IP65	494Lm	103Lm

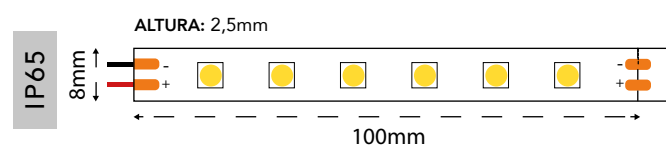
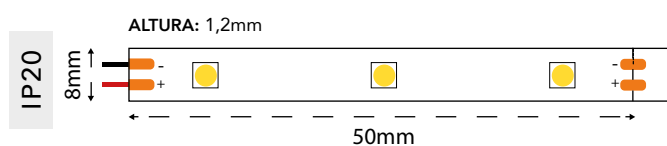
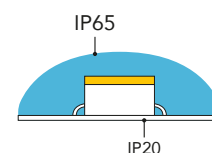
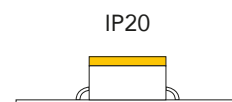

PUCK 5W IP20



8 mm | 5W/m | IP20 | 2220 LED | 140 LED/m | 5m | CONEXÃO MÁXIMA 5m | DIMÁVEL | CRI 90 | 120° | M M | CE

Modelo	Ref.	Efic.	Cor Color	Tensão Tensión	IP	Lumens /mt	Lumens /w
PUCK	1315721.0527	G	2700K	24V	IP20	380Lm	76Lm
L70B50 50000H	1315721.0530	G	3000K	24V	IP20	400Lm	80Lm
3 Steps MacAdam	1315721.0540	F	4000K	24V	IP20	460Lm	92Lm

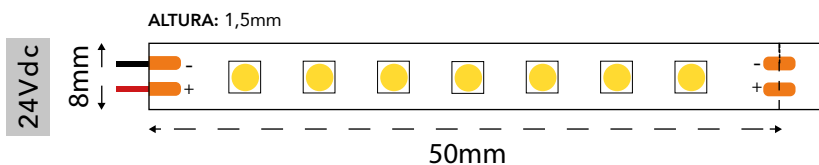
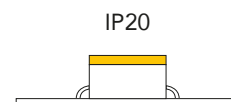

SUGESTÕES | SUGERENCIAS

Perfil Cristal
Ref. PFD0101
Pág. 414



Filtro de Proteção
12-48Vdc 5A 8A Cor Simples
Filtro de Protección Color Simple
Ref. 2238279.8192



SAFIRA 6,3W IP20



Modelo	Ref.	Efic.	Cor Color	Tensão Tensão	IP	Lumens /mt	Lumens /w
	1325461.0627	C	2700K	24V	IP20	1200Lm	190Lm
SAFIRA	1325461.0630	B	3000K	24V	IP20	1260m	200Lm
L80B10 50000H	1325461.0640	B	4000K	24V	IP20	1323Lm	210Lm
	1325461.0660	B	6500K	24V	IP20	1323Lm	210Lm

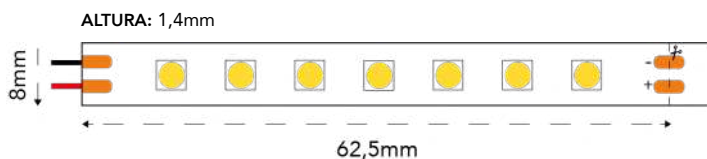
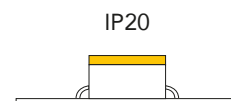

SUGESTÕES | SUGERENCIAS

Perfil Alvor
ANODIZADO
Ref. PFA81021
Pág. 454



Controlador Dimmer
RF+WIFI+PUSH NEXTA
Ref. 2127218.4240
Pág. 369



Mini Comando RF
1 ZONA DIM C/BATERIA
Ref. 2127259.1
Pág. 374



PÃ 7W IP20

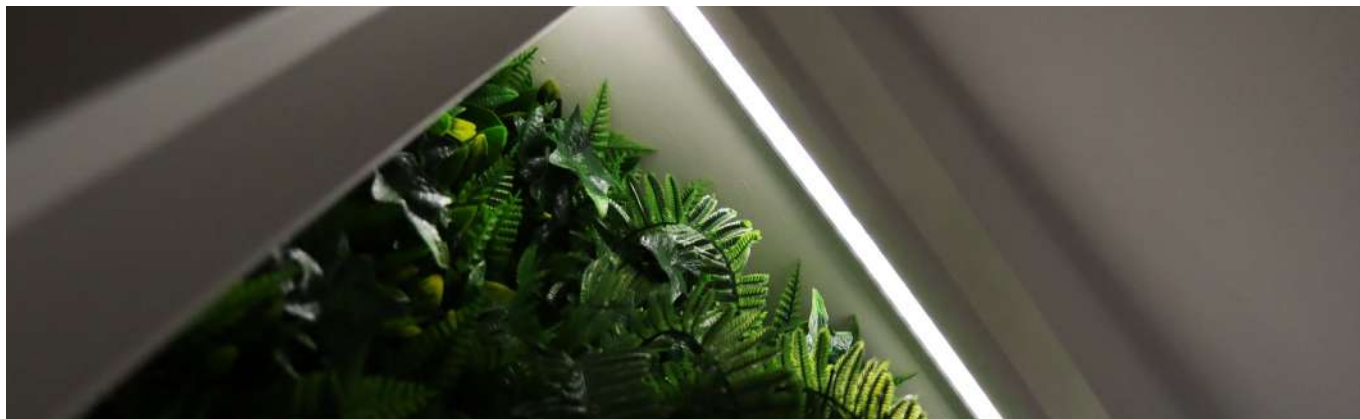

5 mm 7W m IP20 20Z 2220 LED 240 LED/m 5m CONEXÃO MÁXIMA 5m DIMÁVEL CRI 90 120° M M CE

Modelo	Ref.	Efic.	Cor Color	Tensão Tensión	IP	Lumens /mt	Lumens /w
PÃ L70B50 50000H 3 Steps MacAdam	139741.0727	G	2700K	24V	IP20	520Lm	74Lm
	139741.0730	G	3000K	24V	IP20	540Lm	77Lm
	139741.0740	G	4000K	24V	IP20	600Lm	86Lm
	139741.0760	G	6000K	24V	IP20	680Lm	97Lm

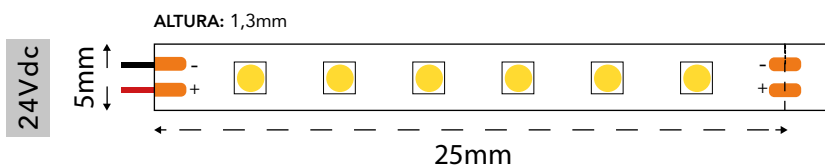
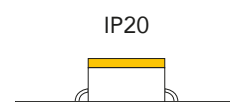

SUGESTÕES | SUGERENCIAS

Perfil redondo Mico
Ref. PFA1301
Pág. 490



Filtro de Proteção
12-48Vdc 5A 8A Cor Simples
Filtro de Protección Color Simple
Ref. 2238279.8192



FRANCISCO 7W IP20 | IP68



* ESTA FITA LED NÃO INCLUI FITA ADESIVA
Esta tira de led no incluye cinta adhesiva.



Modelo	Ref.	Cor Color	Tensão Tensión	IP	Numens
FRANCISCO	130151.07RGB	RGB	24V	IP20	R: 625Nm G: 532Nm B: 475Nm
FRANCISCO 68	130157.07RGB	RGB	24V	IP68	R: 625Nm G: 532Nm B: 475Nm

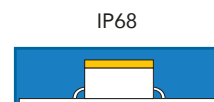
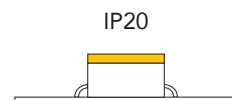

ALTURA IP20: 2,2mm | ALTURA IP68: 2,5mm

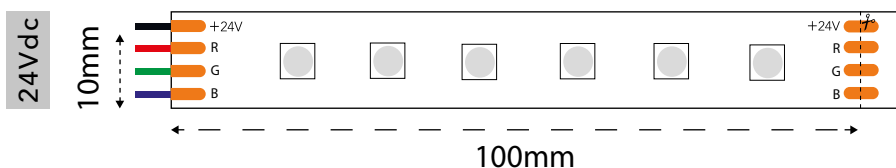

SUGESTÕES | SUGERENCIAS

<p>Controlador RGB c/ Comando Controlador RGB c/ Mando Ref. 212217.1180 Pág. 334</p> 	<p>Filtro de Proteção Filtro de Protección 12-48Vdc 5A RGBW Ref. 2238278.8120</p> 
--	---

_O mesmo comando poderá controlar até 100 controladores através de programação.

_El mismo mando puede controlar hasta 100 controladores a través de la programación.

KARI 7,2W IP20



Modelo	Ref.	Efic.	Cor Color	Tensão Tensão	IP	Lumens /mt	Lumens /w
KARI	132151.0727	F	2700K	24V	IP20	684Lm	105Lm
L70B50 36000H	132151.0730	F	3000K	24V	IP20	790Lm	110Lm
3 Steps MacAdam	132151.0740	F	4000K	24V	IP20	756Lm	115Lm
	132151.0760	F	6000K	24V	IP20	756Lm	115Lm

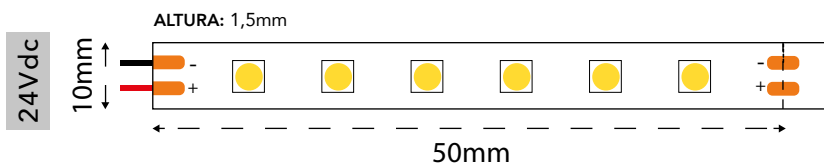
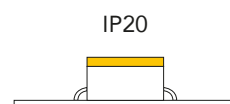

SUGESTÕES | SUGERENCIAS

Difusor em rolo*
Difusor en rollo*
Pág. 402



Filtro de Proteção
12-48Vdc 5A 8A Cor Simples
Filtro de Protección Color Simple
Ref. 2238279.8192



*Consiga uma linha de luz contínua com o nosso difusor em rolo de 20mt.

*Consiga una línea continua de luz con nuestro difusor en rollo de 20mt.

SURTUR 7,2W IP20



7,2W/m IP20 20Z 2835 LED 60 LED/m 5m CONEXÃO MÁXIMA 5m DIMÁVEL CRI 80 120° M M CE

Modelo	Ref.	Efic.	Cor Color	Tensão Tensión	IP	Lumens /mt	Lumens /w
SURTUR	13011.0727	G	2700K	12V	IP20	620Lm	100Lm
	13011.0730	G	3000K	12V	IP20	630Lm	102Lm
	13011.0740	F	4000K	12V	IP20	670Lm	106Lm
	L70B50	F	6000K	12V	IP20	670Lm	106Lm
36000H	13041.0727	G	2700K	24V	IP20	620Lm	100Lm
3 Steps	13041.0730	G	3000K	24V	IP20	630Lm	102Lm
MacAdam	13041.0740	F	4000K	24V	IP20	670Lm	106Lm
	13041.0760	F	6000K	24V	IP20	670Lm	106Lm
SURTUR 50M	1301341.0727	F	2700K	24V	IP20	670Lm	93Lm
	1301341.0730	F	3000K	24V	IP20	680Lm	94Lm
	1301341.0740	F	4000K	24V	IP20	694Lm	96Lm
	1301341.0760	F	6000K	24V	IP20	694Lm	96Lm

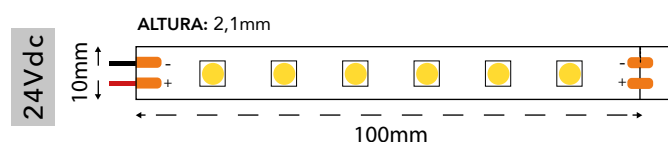
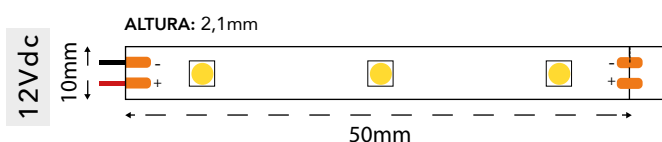
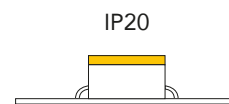

SUGESTÕES | SUGERENCIAS

Filtro de Proteção
12-48Vdc 5A 8A Cor Simples
Filtro de Protección Color Simple
Ref. 2238279.8192



SURTUR 7,2W IP65



Modelo	Ref.	Efic.	Cor Color	Tensão Tensão	IP	Lumens /mt	Lumens /w
SURTUR 65 L70B50 50000H	13015.0730	G	3000K	12V	IP65	655Lm	91Lm
	13015.0740	F	4000K	12V	IP65	700Lm	97Lm
	13015.0760	G	6000K	12V	IP65	700Lm	97Lm
	13045.0727	G	2700K	24V	IP65	653Lm	91Lm
	13045.0730	G	3000K	24V	IP65	655Lm	91Lm
	13045.0740	F	4000K	24V	IP65	700Lm	97Lm
	13045.0760	F	6000K	24V	IP65	700Lm	97Lm

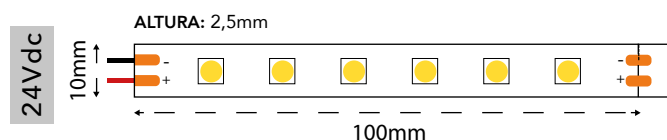
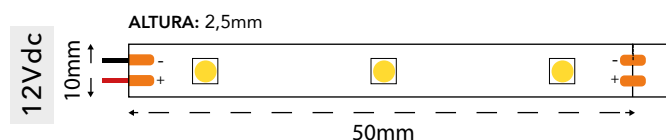
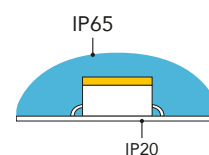

SUGESTÕES | SUGERENCIAS

Perfil Crato
Ref. PFG02034
Pág. 446



Filtro de Proteção
12-48Vdc 5A 8A Cor Simples
Filtro de Protección Color Simple
Ref. 2238279.8192



JULIETA 7,2W IP20 | IP65

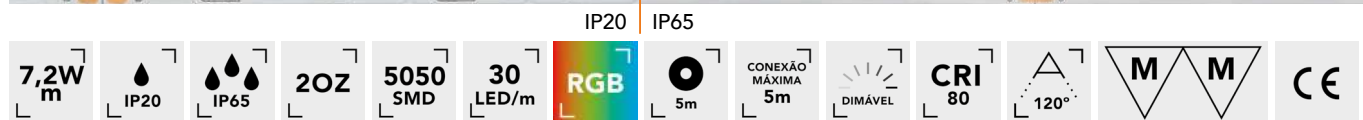

Modelo	Ref.	Cor Color	Tensão Tensión	IP	Numens
JULIETA	13141.07RGB	RGB	24V	IP20	R: 625Nm G: 532Nm B: 475Nm
JULIETA 65	13145.07RGB	RGB	24V	IP65	

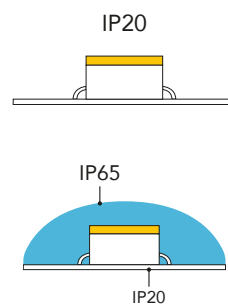

ALTURA IP20: 2,2mm | ALTURA IP65: 2,5mm

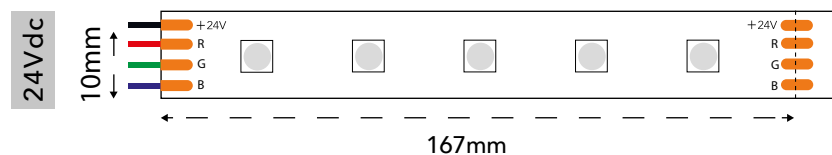

SUGESTÕES | SUGERENCIAS

CONTROLO POR CASAMBI:
CONTROL POR CASAMBI:
Controlador Dimmer 4x5A Push
Dalcnet
Ref. 2113224.4240
Pág. 341



Filtro de Proteção
12-48Vdc 5A 8A Cor Simples
Filtro de Protección Color Simple
Ref. 2238279.8192



_Controlador CASAMBI com 4 entradas e 4 saídas.
_Ideal para controlar RGB, RGB+W, RGBW, 4xDim, controle temperatura de color.

_Controlador CASAMBI de 4 entradas y 4 salidas.
_Ideal para controlar RGB, RGB+W, RGBW, 4xDim, control de temperatura de color.

MAB 9W IP20



EF+	9W/m	IP20	30Z	2835 SMD	180 LED/m	1692 Lm/m	188 Lm/W	5m	CONEXÃO MÁXIMA 5m	DIMÁVEL	CRI 90	M M	CE
------------	-------------	-------------	------------	-----------------	------------------	------------------	-----------------	-----------	--------------------------	----------------	---------------	------------	-----------

Modelo	Ref.	Efic.	Cor Color	Tensão Tensión	IP	Lumens /mt	Lumens /w
MAB L70B50 50000H	133121.0927	C	2700K	24V	IP20	1638Lm	182Lm
	133121.0930	C	3000K	24V	IP20	1638Lm	182Lm
	133121.0940	C	4000K	24V	IP20	1692Lm	188Lm

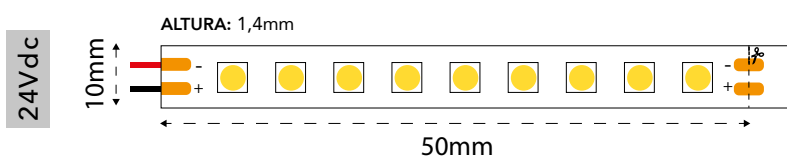
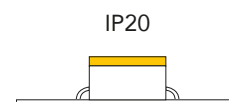

SUGESTÕES | SUGERENCIAS

Controlador Dimmer Dali Nexta Ref. 2127258.DA20 Pág. 369



Filtro de Proteção 12-48Vdc 5A 8A Cor Simples Filtro de Protección Color Simple Ref. 2238279.8192



ZIG ZAG (TIPO S) 9,6W IP20



9,6W/m IP20 20Z 2835 LED 60 LED/m 5m CONEXÃO MÁXIMA 5m DIMÁVEL CRI 80 120° M M CE

Modelo	Ref.	Efic.	Cor Color	Tensão Tensión	IP	Lumens /mt	Lumens /w
ZIG ZAG L70B50 50000H	130121.0930	G	2700K	12V	IP20	843Lm	88Lm
	130121.0940	F	4000K	12V	IP20	954Lm	92Lm
	130121.0960	F	6000K	12V	IP20	950Lm	99Lm
	130111.0927	G	2700K	24V	IP20	843Lm	88Lm
	130111.0930	G	3000K	24V	IP20	880Lm	92Lm
	130111.0940	F	4000K	24V	IP20	954Lm	99Lm
	130111.0960	F	6000K	24V	IP20	950Lm	99Lm

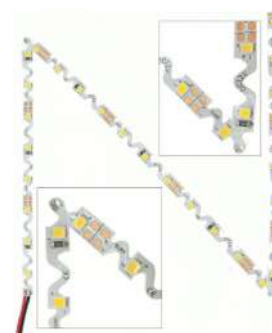
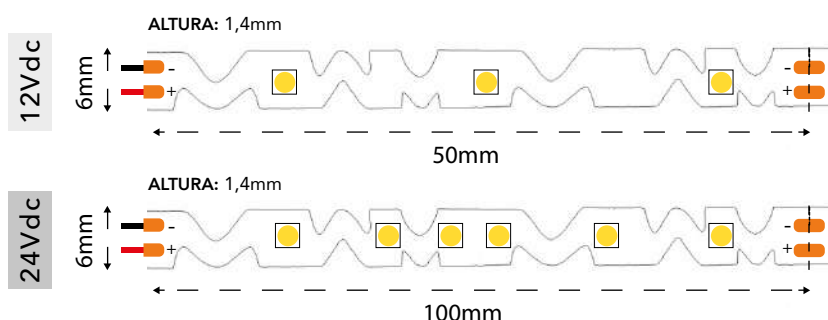
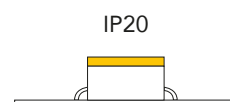

SUGESTÕES | SUGERENCIAS

Perfil Pena
Ref. PFD0081
Pág. 410



Filtro de Proteção
12-48Vdc 5A 8A Cor Simples
Filtro de Protección Color Simple
Ref. 2238279.8192



HIGH ZIG ZAG (TIPO S) 10W IP20



Modelo	Ref.	Efic.	Cor Color	Tensão Tensión	IP	Lumens /mt	Lumens /w
ZIG ZAG ALTA EFICIÊNCIA	13111471.1027	E	2700K	24V	IP20	1320Lm	132Lm
	13111471.1030	E	3000K	24V	IP20	1370Lm	137Lm
L80B10 49000H	13111471.1040	D	4000K	24V	IP20	1500Lm	150Lm
	13111471.1065	D	6500K	24V	IP20	1500Lm	150Lm

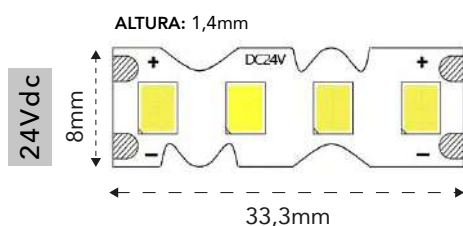
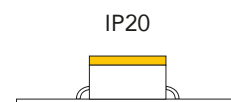

SUGESTÕES | SUGERENCIAS

Perfil Alenquer
FLEXÍVEL
Ref. PFA18881
Pág. 453



Perfil Alvor
ANODIZADO
Ref. PFA81021
Pág. 454



ZIG ZAG PLUS (TIPO S) 19,2W IP20

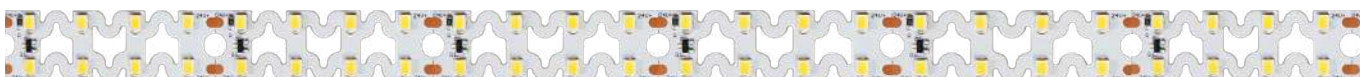

Modelo	Ref.	Efic.	Cor Color	Tensão Tensión	IP	Lumens /mt	Lumens /w
ZIG ZAG PLUS	13111111.1927	D	2700K	24V	IP20	2630Lm	137Lm
	13111111.1930	D	3000K	24V	IP20	2765Lm	144Lm
	13111111.1940	D	4000K	24V	IP20	2900Lm	151Lm
	13111111.1960	D	6000K	24V	IP20	2785Lm	145Lm

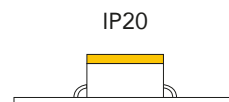

FITAS DE LED

ALTURA: 2mm

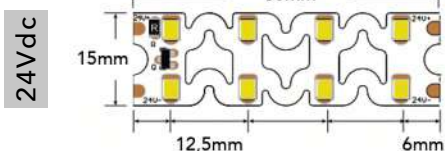

Ideal para aplicar no perfil flexível Montalegre

Ideal para aplicar sobre el perfil flexible Montalegre



SUGESTÕES | SUGERENCIAS

Perfil Flexível Montalegre
Ref. PFA18797
Pág. 459



Filtro de Proteção
12-48Vdc 5A 8A Cor Simples
Filtro de Protección Color Simple
Ref. 2238279.8192



HIGH DUAL ZIG ZAG 14,4W IP20



Modelo	Ref.	Efic.	Cor Color	Tensão Tensión	IP	Lumens /mt	Lumens /w
ZIG ZAG PLUS ALTA EFICIÊNCIA	1391111.1427	E	2700K	24V	IP20	2088Lm	145Lm
	1391111.1430	E	3000K	24V	IP20	2115Lm	147Lm
L80B10 49000H	1391111.1440	D	4000K	24V	IP20	2305Lm	160Lm
	1391111.1460	D	6500K	24V	IP20	2305Lm	160Lm

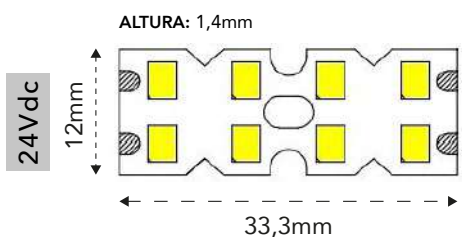
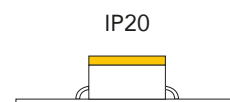

SUGESTÕES | SUGERENCIAS

Perfil Montalegre
FLEXÍVEL
Ref. PFA18797
Pág. 459

Perfil Portalegre
FLEXÍVEL
Ref. PFA181181
Pág. 458



ELARA/HIGH ELARA 9,6W IP20

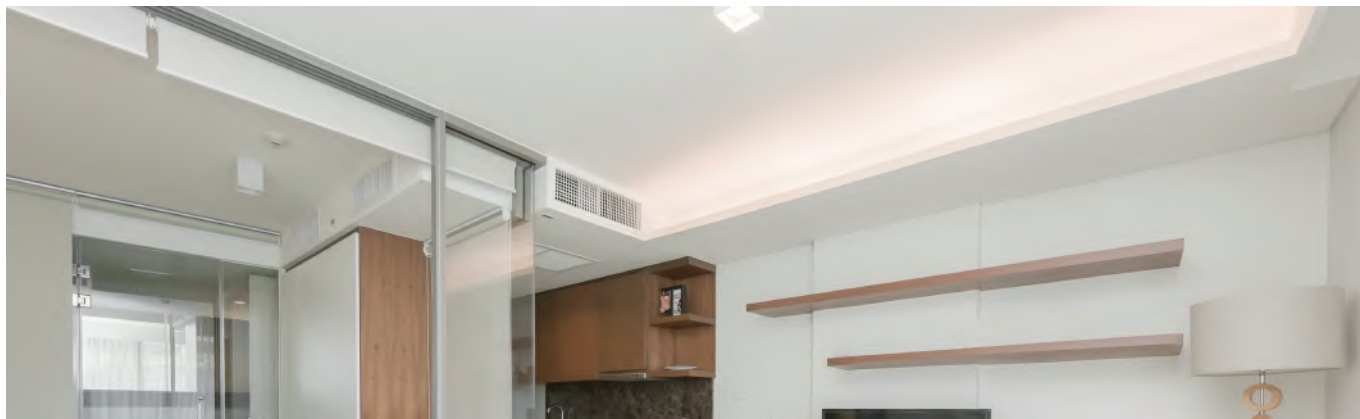

EF+
9,6W/m
IP20
2835 SMD
5m
CONEXÃO MÁXIMA 5m
DIMÁVEL
CRI 80
120°
M M
CE
R2R NOVA TECNOLOGIA

Modelo	Ref.	Efic.	Cor Color	Tensão Tensión	IP	Lumens /mt	Lumens /w
HIGH ELARA L70B50 50000h	13111191.0927	E	2700K	24V	IP20	1240Lm	129Lm
	13111191.0930	E	3000K	24V	IP20	1270Lm	132Lm
	13111191.0940	D	4000K	24V	IP20	1410Lm	147Lm
ELARA* L70B50 36000h	132141.0927*	G	2700K	24V	IP20	860Lm	90Lm
	132141.0930*	G	3000K	24V	IP20	870Lm	91Lm
	132141.0940*	F	4000K	24V	IP20	920Lm	96Lm
3 Steps MacAdam	132141.0960*	F	6000K	24V	IP20	920Lm	96Lm

160 LED/m

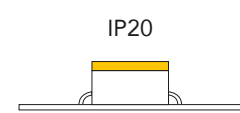

120 LED/m

*NOTA: Após descontinuação a fita Elara (132141.09XX) terá como alternativa a fita High Elara (13111191.09XX).
Tras la discontinuación de la cinta Elara (132141.09XX), la alternativa será la cinta High Elara (13111191.09XX).

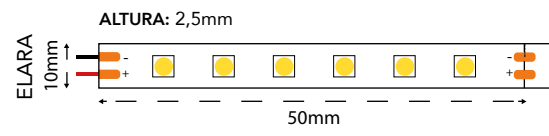
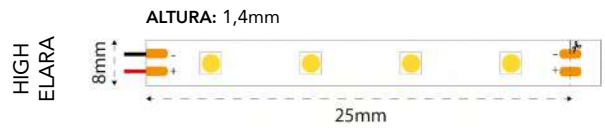

SUGESTÕES | SUGERENCIAS

Perfil Loulé
Ref. PFA8821
Pág. 452

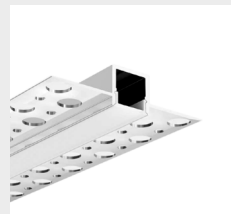

Filtro de Proteção
12-48Vdc 5A 8A Cor Simples
Filtro de Protección Color Simple
Ref. 2238279.8192



ELARA 65/ ELARA 67 9,6W IP65 | IP67

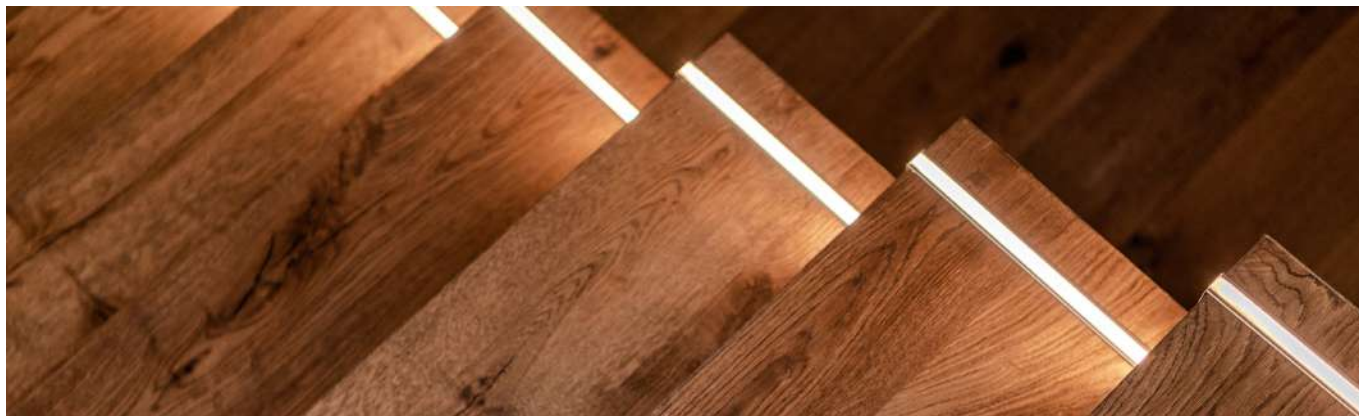

IP65 | IP67



Modelo	Ref.	Efic.	Cor Color	Tensão Tensión	IP	Lumens /mt	Lumens /w
ELARA 65 L70B50 36000h 3 Steps MacAdam	131145.0927	E	2700K	24V	IP65	1170Lm	122Lm
	131145.0930	E	3000K	24V	IP65	1260Lm	131Lm
	131145.0940	E	4000K	24V	IP65	1280Lm	133Lm
ELARA 67	131146.0927	F	2700K	24V	IP67	1030Lm	107Lm
	131146.0930	F	3000K	24V	IP67	1080Lm	113Lm
	L70B50 36000h 131146.0940	D	4000K	24V	IP67	1200Lm	125Lm
	131146.0960	D	6000K	24V	IP67	1250Lm	130Lm

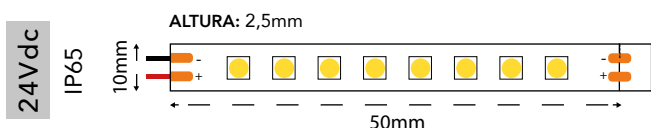
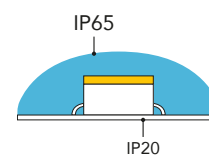

SUGESTÕES | SUGERENCIAS

Perfil Dual
Ref. PFA1601
Pág. 418



LUMINES LIGHTING

Filtro de Proteção
12-48Vdc 5A 8A Cor Simples
Filtro de Protección Color Simple
Ref. 2238279.8192



LATERAL MIMAS 9,6W IP20

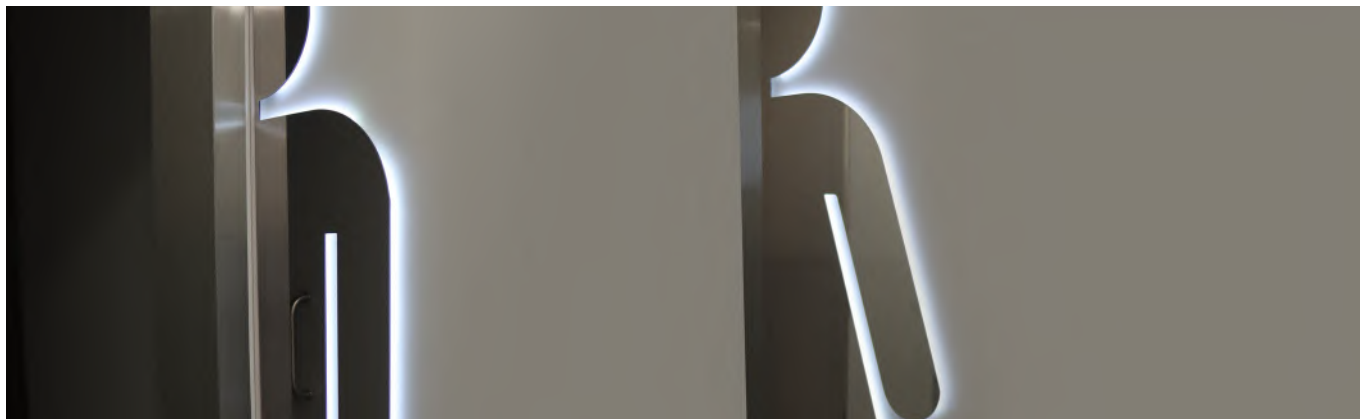

8 mm | 9,6W/m | IP20 | 30Z | 3014 SMD | 120 LED/m | 5m | CONEXÃO MÁXIMA 5m | DIMÁVEL | CRI >90 | M M | CE

Modelo	Ref.	Efic.	Cor Color	Tensão Tensión	IP	Lumens /mt	Lumens /w
MIMAS	1329291.0927	G	2700K	24V	IP20	691Lm	71Lm
L70B10 50000H 5 Steps MacAdam	1329291.0930	G	3000K	24V	IP20	720Lm	74Lm
	1329291.0940	G	4000K	24V	IP20	748Lm	78Lm

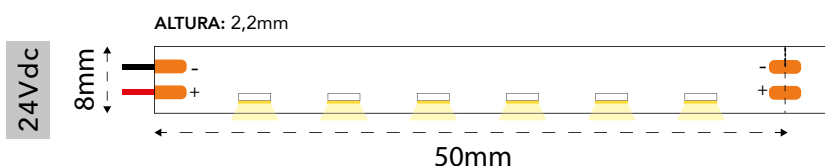
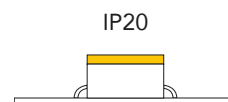

DESTAQUE | DESTACADO

Projeção de luz lateral | Proyección de luz lateral

SUGESTÕES | SUGERENCIAS

Perfil Tipo E
Ref. PFA6371
Pág. 496



Filtro de Proteção
12-48Vdc 5A 8A Cor Simples
Filtro de Protección Color Simple
Ref. 2238279.8192



REIA 9,6W IP20



9,6W/m | IP20 | 30Z | 2835 LED | 120 LED/m | CONEXÃO MÁXIMA 15m | DIMÁVEL | CRI 80 | 120° | M M | CE

Modelo	Ref.	Efic.	Cor Color	Tensão Tensión	IP	Lumens /mt	Lumens /w
REIA L70B50 36000H 3 Steps MacAdam	132151.0927	F	2700K	24V	IP20	912Lm	95Lm
	132151.0930	F	3000K	24V	IP20	940Lm	98Lm
	132151.0940	F	4000K	24V	IP20	1008Lm	105Lm
	132151.0960	F	6000K	24V	IP20	1008Lm	105Lm

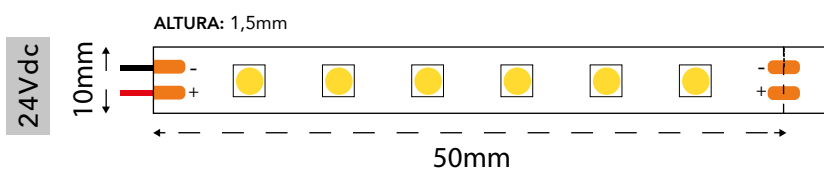
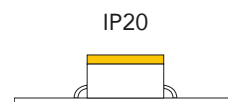

SUGESTÕES | SUGERENCIAS

Perfil Penegache 6mt
Perfil Penegache 6mt
Ref. PFA2461.6
Pág. 438



Filtro de Proteção
12-48Vdc 5A 8A Cor Simples
Filtro de Protección Color Simple
Ref. 2238279.8192



CSP LOW OBERON 9,6W IP67



Modelo	Ref.	Efic.	Cor Color	Tensão Tensión	IP	Lumens /mt	Lumens /w
LOW OBERON	133612266.0927	G	2700K	24V	IP67	898Lm	94Lm
	133612266.0930	F	3000K	24V	IP67	946Lm	99Lm
L70B50 36000H	133612266.0940	F	4000K	24V	IP67	980Lm	102Lm
	133612266.0950	F	5000K	24V	IP67	934Lm	97Lm

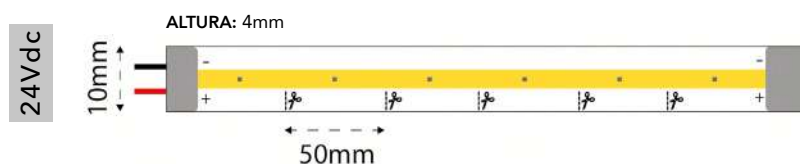
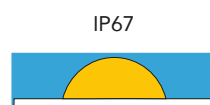

SUGESTÕES | SUGERENCIAS

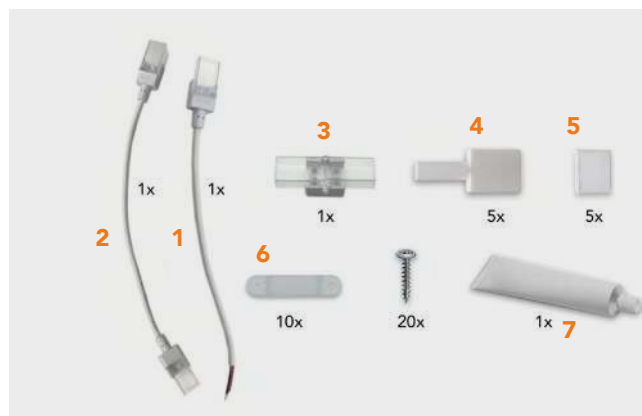

Acessórios disponíveis individualmente Accesorios disponibles individualmente

- Conector c/cabo
Conector c/cable
Ref. 22181.50
- Unições c/cabo
Uniones c/cable
Ref. 2213.50
- Unições s/cabo
Uniones s/cable
Ref. 2211.50
- Topo c/furo
Tapa c/agujero
Ref. 225.50
- Topo s/ furo
Tapa s/agujero
Ref. 226.5
- Abraçadeiras transparentes c/parafuso
Abrazaderas transparentes c/tornillo
Ref. 22257
- Silicone isolante
Silicona aislante
Ref. 22258

CALISTO 9,6W IP65

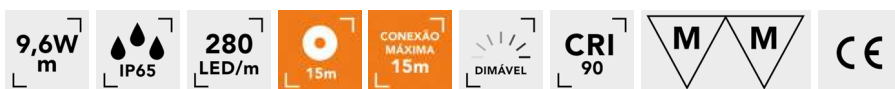

Modelo	Ref.	Cor Color	Tensão Tensión	IP	Lumens /mt	Lumens /w
CALISTO 54000h	132355.0922	2200K	24V	IP65	840Lm	88Lm
	132355.0927	2700K	24V	IP65	900Lm	94Lm
	132355.0930	3000K	24V	IP65	960Lm	100Lm
	132355.0940	4000K	24V	IP65	980Lm	102Lm
	132355.0957	5700K	24V	IP65	980Lm	102Lm

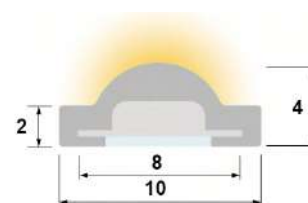
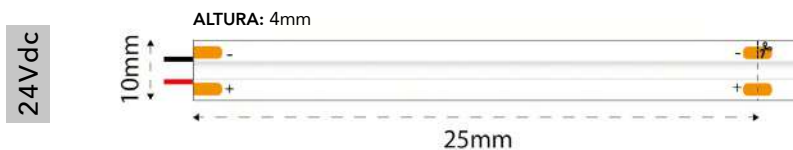
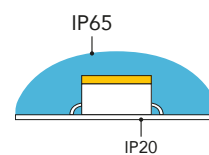

ACESSÓRIOS RECOMENDADOS | ACCESORIOS RECOMENDADOS

Topo final Tapa final Ref. 226.69	Topo final c/ furo Tapa final c/ agujero Ref. 225.69	Conector 2 pólos de ligação rápida Conector de conexão rápida de 2 polos Ref. 221215.69	Calha fixadora AL de encastre 1mt Perfil de fijación AL de empotrar 1mt Ref. PF2821	Calha fixadora AL 1mt Perfil de fijación AL 1mt Ref. PF1821

TEBE 9,6W IP67



9,6W/m
IP67
CRI 90
2835 LED
128 LED/m
30Z
10m
CONEXÃO MÁXIMA 10m
DIMÁVEL
M M
CE
NOVO NUEVO

Modelo	Ref.	Cor Color	Tensão Tensión	IP	Lumens /mt	Lumens /w
TEBE	1340126.0927	2700K	24V	IP67	1300Lm	135Lm
	1340126.0930	3000K	24V	IP67	1330Lm	138Lm
	1340126.0940	4000K	24V	IP67	1370Lm	142Lm
	1340126.0965	6500K	24V	IP67	1370Lm	142Lm

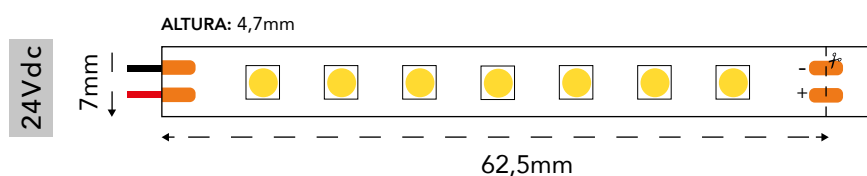
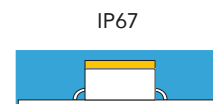

SUGESTÕES | SUGERENCIAS

Perfil Andorra
ANODIZADO
Ref. PFA111
Pág. 413

Perfil Loulé
ANODIZADO
Ref. PFA8821
Pág. 452

Fonte de Alimentação
PFC Eagle Rise 24Vdc 160W
Ref. 2018352.2160
Pág. 272





MULTIPOWER 4,8W | 9,6W | 12,5W IP20

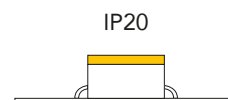
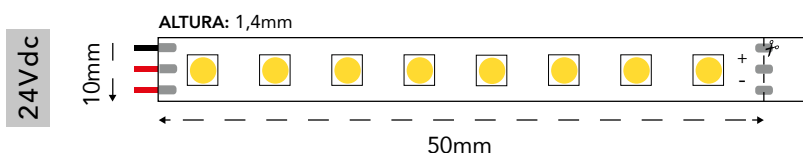

Modelo	Ref.	Efic.	Cor Color	Tensão Tensión	IP	Potência /mt	Lumens /mt	Conexão Conexión
MULTIPOWER L80B10 50000H	13111451.41224	E	2400K	24V	IP20	4,8W	576Lm	5mt
		E	2400K	24V	IP20	9,6W	1152Lm	5mt
		E	2400K	24V	IP20	12,5W	1500Lm	5mt
	13111451.41227	E	2700K	24V	IP20	4,8W	648Lm	5mt
		E	2700K	24V	IP20	9,6W	1296Lm	5mt
		E	2700K	24V	IP20	12,5W	1685Lm	5mt
	13111451.41230	E	3000K	24V	IP20	4,8W	670Lm	5mt
		E	3000K	24V	IP20	9,6W	1340Lm	5mt
		E	3000K	24V	IP20	12,5W	1750Lm	5mt
	13111451.41240	D	4000K	24V	IP20	4,8W	720Lm	5mt
		D	4000K	24V	IP20	9,6W	1440Lm	5mt
		D	4000K	24V	IP20	12,5W	1875Lm	5mt
13111451.41250	D	6500K	24V	IP20	4,8W	720Lm	5mt	
	D	6500K	24V	IP20	9,6W	1440Lm	5mt	
	D	6500K	24V	IP20	12,5W	1875m	5mt	

Três opções de potência numa única fita led, selecionadas pela conexão de cabos.
 Tres opciones de potencia en una sola tira LED, seleccionadas mediante la conexión de cables.





Neste ambiente, a iluminação led desenha o espaço e cria uma sensação de amplitude, leveza e sofisticação. Mais do que iluminar, a nossa iluminação transmite conforto visual e reforça uma atmosfera profissional, serena e produtiva. Ideal para ambientes de trabalho modernos e funcionais.

En este entorno, la iluminación LED diseña el espacio y crea una sensación de amplitud, ligereza y sofisticación. Más que iluminar, nuestra iluminación transmite confort visual y refuerza un ambiente profesional, sereno y productivo. Ideal para entornos de trabajo modernos y funcionales.

COB CALE 10W IP20

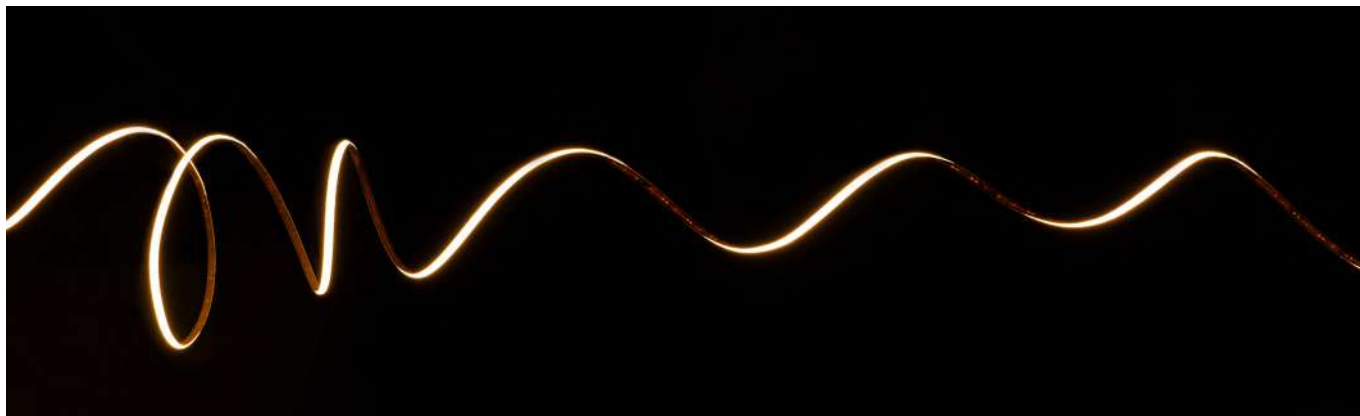

4 mm | 10W/m | IP20 | 420 LED/m | 2OZ | LED COB | 2,5m | CONEXÃO MÁXIMA 2,5m | DIMÁVEL | CRI 90 | 180° | M M | CE

Modelo	Ref.	Efic.	Cor Color	Tensão Tensão	IP	Lumens /mt	Lumens /w
COB CALE 36000H 3 Steps MacAdam	131121.1027	G	2700K	24V	IP20	610Lm	68Lm
	131121.1030	G	3000K	24V	IP20	680Lm	76Lm
	131121.1040	G	4000K	24V	IP20	760Lm	85Lm
	131121.1065	F	6500K	24V	IP20	810Lm	90Lm

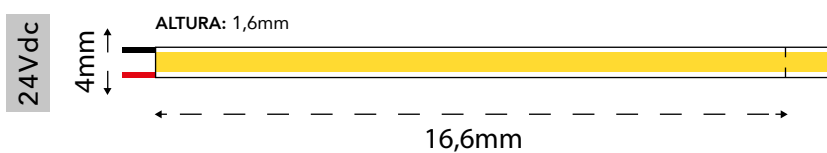
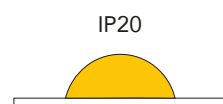

SUGESTÕES | SUGERENCIAS

Perfil Pena
Ref. PFD0081
Pág. 410



Filtro de Proteção
12-48Vdc 5A 8A Cor Simples
Filtro de Protección Color Simple
Ref. 2238279.8192



COB CARPO 10W IP20

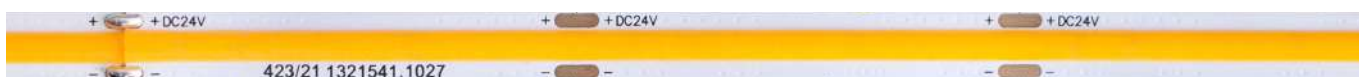

8 mm | 10W/m | IP20 | LED COB | 488 LED/m | 5m | CONEXÃO MÁXIMA 5m | DIMÁVEL | CRI 80 | 180° | M M | CE

Modelo	Ref.	Efic.	Cor Color	Tensão Tensión	IP	Lumens /mt	Lumens /w
COB CARPO	1321511.1027	F	2700K	12V	IP20	720Lm	72Lm
	1321511.1030	G	3000K	12V	IP20	800Lm	80Lm
	1321511.1040	F	4000K	12V	IP20	850Lm	85Lm
	1321511.1060	F	6000K	12V	IP20	890Lm	89Lm
COB CARPO L70B50 54000H 1 Steps MacAdam	1321541.1027	F	2700K	24V	IP20	960Lm	96Lm
	1321541.1030	G	3000K	24V	IP20	910Lm	91Lm
	1321541.1040	F	4000K	24V	IP20	1060Lm	106Lm
COB CARPO 50M	13255341.1027	F	2700K	24V	IP20	960Lm	96Lm
	13255341.1030	G	3000K	24V	IP20	910Lm	91Lm
	13255341.1040	F	4000K	24V	IP20	1060Lm	106Lm

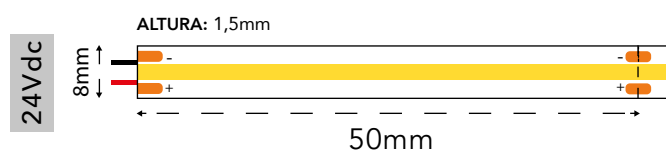
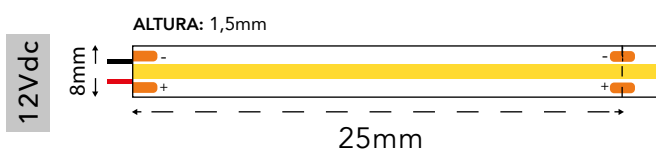
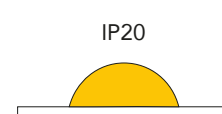

DESTAQUE | DESTACADO

Gama STANDARD

166 M O T A K O

MEGACLITE DIM-TO-WARM 10W IP20

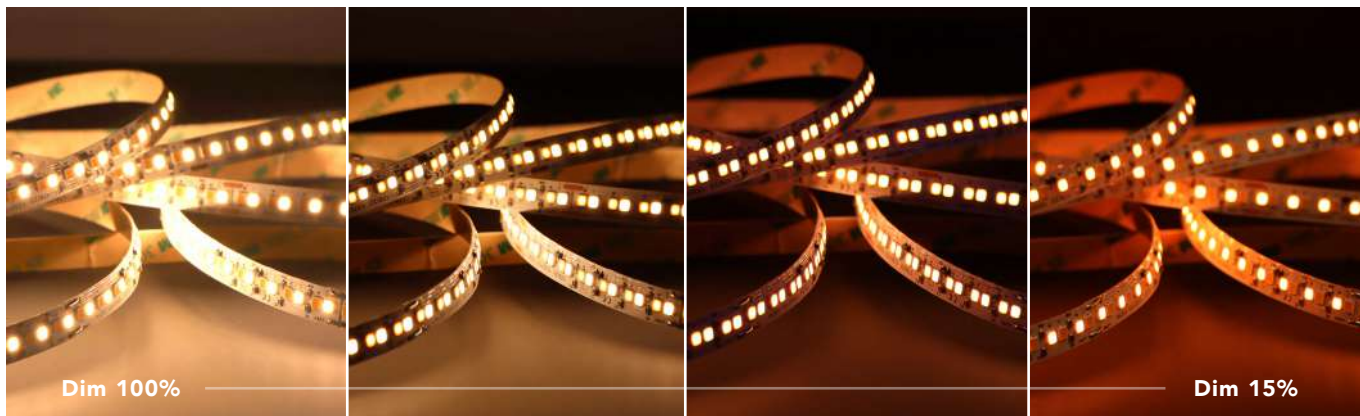

10W/m	IP20	2835 SMD	224 LED/m	5m	CONEXÃO MÁXIMA 5m	DIMÁVEL	20Z	CRI 90	120°	M M	CE
-------	------	----------	-----------	----	-------------------	---------	-----	--------	------	-----	----

Modelo	Ref.	Efic.	Cor Color	Tensão Tensión	IP	Lumens /mt	Lumens /w
MEGACLITE L70B50 50000H	13351151.10DW	F	1800K a 3000K	24V	IP20	1010Lm	10Lm

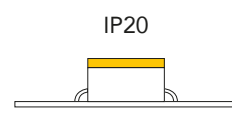

Ideal para criar ambientes acolhedores. Permite reduzir/aumentar a intensidade luminosa. Ao reduzir a fita também diminui em simultâneo a cor de luz dos 3000K aos 1800K e vice versa.

Ideal para crear ambientes acogedores. Le permite reducir/aumentar la intensidad de la luz. Al reducir la cinta también reduce simultáneamente el color de la luz de 3000K a 1800K y viceversa.

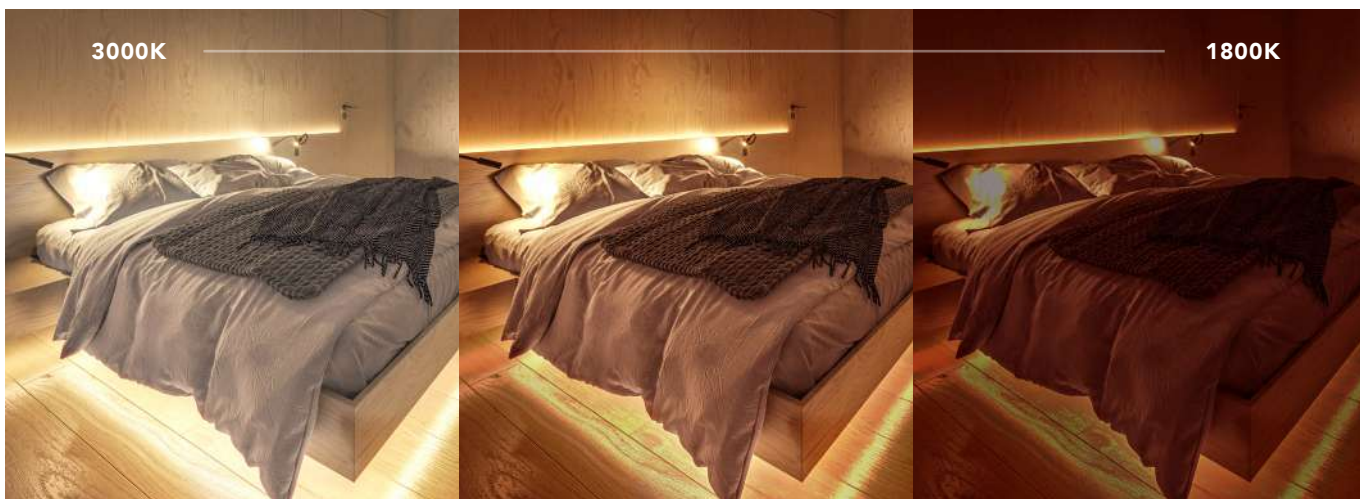

CSP TEMISTO 10W IP20



10W/m
IP20
CSP LED
320 LED/m
5m
CONEXÃO MÁXIMA 5m
DIMÁVEL
CRI 90
M M
CE

Modelo	Ref.	Cor Color	Tensão Tensión	IP	Lumens /mt	Lumens /w
CSP TEMISTO	133612191.1027	2700K	24V	IP20	780Lm	78Lm
	133612191.1030	3000K	24V	IP20	780Lm	78Lm
	133612191.1040	4000K	24V	IP20	890Lm	89Lm
	133612191.1060	6000K	24V	IP20	890Lm	89Lm

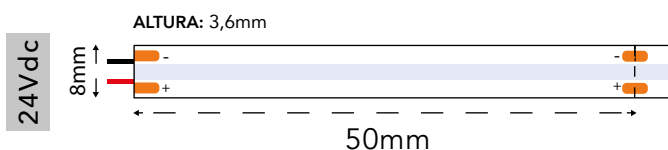
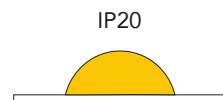

DESTAQUE | DESTACADO

LED CSP

SUGESTÕES | SUGERENCIAS

Fonte 2 em 1
 Fuente 2 en 1
 Ref. 2021881.275
 Pág. 280



Filtro de Proteção
 12-48Vdc 5A 8A Cor Simples
 Filtro de Protección Color Simple
 Ref. 2238279.8192



HERMIPE 10W IP20 | IP67



10W/m
IP20
IP67
30Z
2835 SMD
144 LED/m
CRI 80
35m
CONEXÃO MÁXIMA 35m
48 VDC
DIMÁVEL
M M
CE

Modelo	Ref.	Efic.	Cor Color	Tensão Tensión	IP	Lumens /mt	Lumens /w
HERMIPE L80B10 50000H	1325151.1027*	F	2700K	48V	IP20	970Lm	97Lm
	1325151.1030*	F	3000K	48V	IP20	1020Lm	102Lm
	1325151.1040*	F	4000K	48V	IP20	1100Lm	110Lm
	1325151.1060*	F	6500K	48V	IP20	1040Lm	104Lm
HERMIPE 67 L70B50 36000H	1325156.1027	G	2700K	48V	IP67	810Lm	81Lm
	1325156.1030	G	3000K	48V	IP67	870Lm	87Lm
	1325156.1040	F	4000K	48V	IP67	930Lm	93Lm
	1325156.1060	F	6500K	48V	IP67	970Lm	97Lm

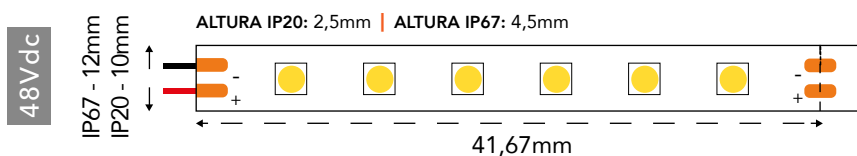
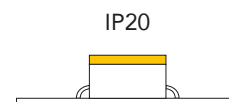

*Referências alternativas às referências 132151.10XX após descontinuação.

* Referencias alternativas a las referencias 132151.10XX después de la obsolescencia.

SUGESTÕES | SUGERENCIAS

Fonte HLG-600-48
Fuente HLG-600-48
Ref. 203146.7600



_De forma a assegurar o mesmo fluxo de luz ao longo de todo o comprimento de fita recomendamos ligar as alimentações às duas extremidades da fita.

_Para asegurar el mismo flujo de luz en toda la longitud de la tira, recomendamos conectar las fuentes a ambos extremos de la tira.

ARIEL 10W IP20 | IP68



* ESTA FITA LED NÃO INCLUI FITA ADESIVA
Esta tira de led no incluye cinta adhesiva.



10W/m	IP20	IP68	20Z	2835 SMD	70 LED/m	IP20 10m	IP68 20m	CONEXÃO MÁXIMA 20m	DIMÁVEL	CRI 80	120°	M M	CE
-------	------	------	-----	----------	----------	----------	----------	--------------------	---------	--------	------	-----	----

Modelo	Ref.	Efic.	Cor Color	Tensão Tensión	IP	Lumens /mt	Lumens /w
ARIEL	13751.1030	E	3000K	24V	IP20	1250Lm	125Lm
L70B50 50000H	13751.1040	E	4000K	24V	IP20	1270Lm	127Lm
	13751.1060	E	6000K	24V	IP20	1280Lm	128Lm
ARIEL 68	13757.1030	F	3000K	24V	IP68	1110Lm	111Lm
L70B50 36000H	13757.1040	F	4000K	24V	IP68	1150Lm	115Lm
	13757.1060	F	6000K	24V	IP68	1150Lm	115Lm

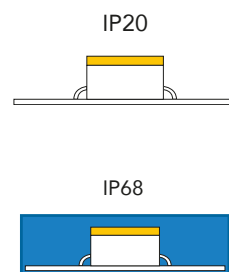

Estas fitas poderão ser ligadas com 20mt com uma única ligação de 24Vdc.
Estas tiras se pueden conectar 20mt con una sola conexión de 24Vdc.

*Disponível também em 10mm nas fitas de IP20 e em 12mm nas fitas de IP68

*También disponible en 10 mm en tiras IP20 y 12 mm en tiras IP68

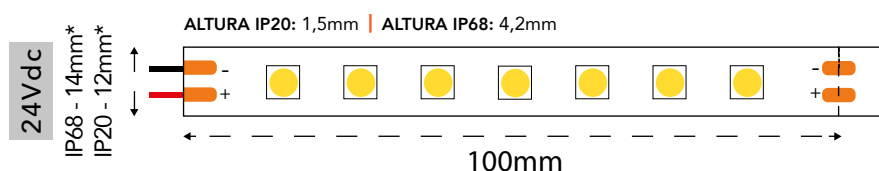

Vulcanização mais estanque
Vulcanização mais estanque



SUGESTÕES | SUGERENCIAS

Fonte ELG-240-24
Fuente ELG-240-24
Ref. 203246.2240
Pág. 277



Filtro de Proteção
12-48Vdc 5A 8A Cor Simples
Filtro de Protección Color Simple
Ref. 2238279.8192



COB HATI 10W IP54



Modelo	Ref.	Efic.	Cor Color	Tensão Tensión	IP	Lumens /mt	Lumens /w
COB HATI	1321515.1030	G	3000K	12V	IP54	860Lm	86Lm
	1321515.1040	F	4000K	12V	IP54	970Lm	97Lm
	1321515.1060	F	6000K	12V	IP54	1020Lm	102Lm
	1321545.1027	G	2700K	24V	IP54	830Lm	83Lm
	1321545.1030	G	3000K	24V	IP54	860Lm	86Lm
	1321545.1040	F	4000K	24V	IP54	970Lm	97Lm
	1321545.1060	F	6000K	24V	IP54	1020Lm	102Lm

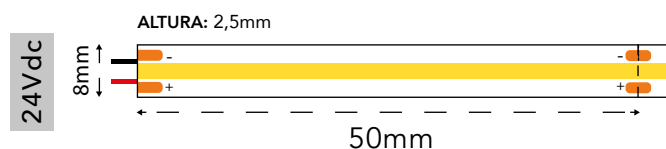
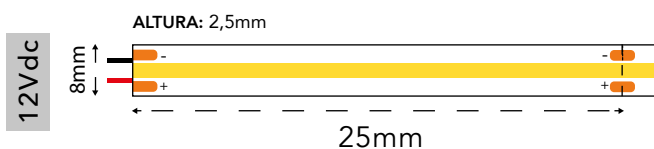
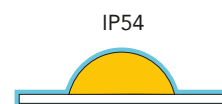

SUGESTÕES | SUGERENCIAS

Fonte VTS
Fuente VTS
Ref. 2018352.260
Pág. 272



Filtro de Proteção
12-48Vdc 5A 8A Cor Simples
Filtro de Protección Color Simple
Ref. 2238279.8192





CSP EUPORIA 10W IP68

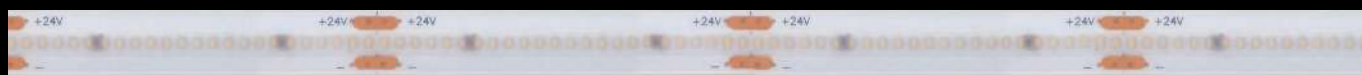

10W/m | IP68 | CSP LED | 320 LED/m | 5m | CONEXÃO MÁXIMA 5m | DIMÁVEL | CRI 90 | M M | CE

Modelo	Ref.	Cor / Color	Tensão Tensión	IP	Lumens /mt	Lumens /w
EUPORIA	133612377.1030	3000K	24V	IP68	970Lm	92Lm
50000H	133612377.1040	4000K	24V	IP68	980Lm	103Lm

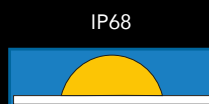
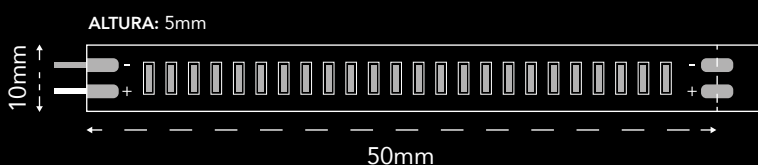



FITA IDEAL PARA: **TEMPERATURAS EXTREMAS**



Ideal para aplicar em ambientes com temperaturas entre -25° e 105° , expostos a elevado grau de humanidade.

Fita extrudida, com led CSP, adequado para resistir a altas temperaturas.

APLICAÇÕES:

- Ambientes gélidos, como expositores frigoríficos
- Saunas e banhos turcos

Ideal para uso en ambientes con temperaturas entre -25° y 105° , expuestos a un alto grado de humanidad.

Tira extrusionada, con LED CSP, apta para resistir altas temperaturas.

APLICACIONES:

- Ambientes fríos, como exhibidores refrigerados.
- Saunas y baños turcos

*** ESTA FITA LED NÃO INCLUI FITA ADESIVA**

Esta tira de led no incluye cinta adhesiva.

COB TITÂNIA 10W IP68



* ESTA FITA LED NÃO INCLUI FITA ADESIVA
Esta tira de led no incluye cinta adhesiva.



10W/m | IP68 | LED COB | 480 LED/m | 5m | CONEXÃO MÁXIMA 5m | DIMÁVEL | CRI 90 | 180° | M M | CE

Modelo	Ref.	Cor Color	Tensão Tensión	IP	Lumens /mt	Lumens /w
COB TITÂNIA	1328527.1030	3000K	24V	IP68	920Lm	92Lm
50000H 3 Steps MacAdam	1328527.1040	4000K	24V	IP68	1030Lm	103Lm
	1328527.1060	6000K	24V	IP68	1020Lm	102Lm

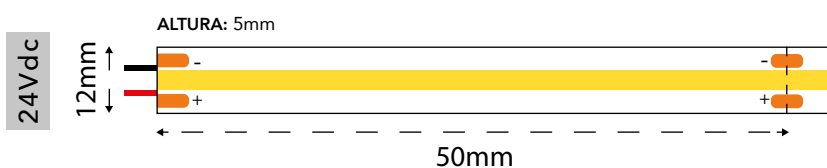
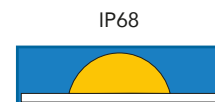

SUGESTÕES | SUGERENCIAS

Perfil Marvão Ref. PFD5371 Pág. 450

CRISTAL 10W IP20 | IP68



10W/m
IP20
IP68
CRI >90
LED COB
480 LED/m
20m
CONEXÃO MÁXIMA 20m
DIMÁVEL
M M
CE
NOVO NUEVO

Modelo	Ref.	Cor Color	Tensão Tensión	IP	Lumens /mt	Lumens /w
CRISTAL L80B10 50000H	13285311.1027	2700K	24V	IP20	880Lm	80Lm
	13285311.1030	3000K	24V	IP20	900Lm	90Lm
	13285311.1040	4000K	24V	IP20	1100Lm	110Lm
	13285311.1060	6500K	24V	IP20	950Lm	95Lm
CRISTAL 68 L70B50 36000H	13285317.1027	2700K	24V	IP68	840Lm	84Lm
	13285317.1030	3000K	24V	IP68	860Lm	86Lm
	13285317.1040	4000K	24V	IP68	1050Lm	105Lm
	13285317.1060	6500K	24V	IP68	900Lm	90Lm

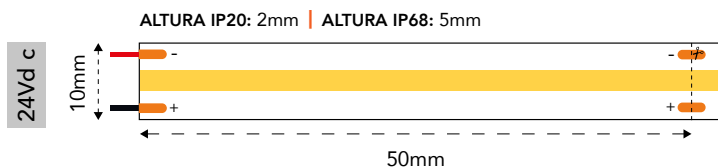
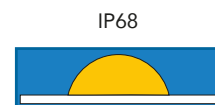
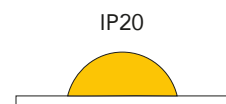

SUGESTÕES | SUGERENCIAS

IP20

Fonte de Alimentação
PFC Eagle Rise 24Vdc 250W
Ref. 201561.2250
Pág. 267



IP68

Topo S/Furo
OBERON
Ref. 22255



Fonte de Alimentação
Mean Well Drive CC+CV 320W 24Vdc
Ref. 203146.2320
Pág. 277



COB E SOB CILENE CORTE LIVRE 11W IP20

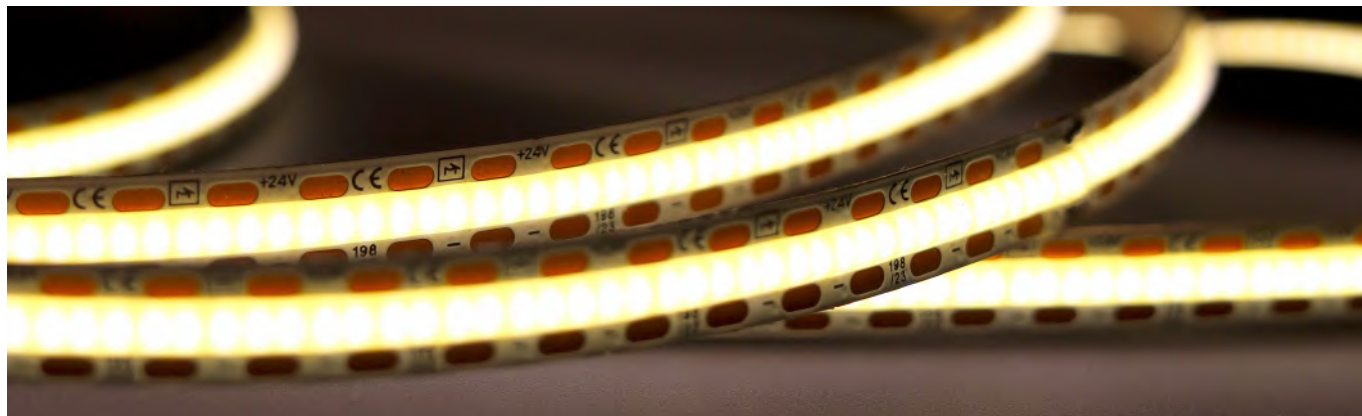

MODELO	REF.	EFIC.	COR COLOR	TENSÃO TENSIÓN	IP	LUMENS/mt	LUMENS/w
COB CILENE CORTE LIVRE L70B50 50000H	13285171.1127		2700K	24V	IP20	605Lm	55Lm
	13285171.1130		3000K	24V	IP20	660Lm	60Lm
	13285171.1140		4000K	24V	IP20	715Lm	65Lm

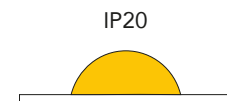

MODELO	REF.	EFIC.	COR COLOR	TENSÃO TENSIÓN	IP	LUMENS/mt	LUMENS/w
SOB CILENE CORTE LIVRE	132314171.1127		2700K	24V	IP20	847Lm	77Lm
	132314171.1130		3000K	24V	IP20	880Lm	80Lm
	132314171.1140		4000K	24V	IP20	913Lm	83Lm
	132314171.1160		6500K	24	IP20	902Lm	82Lm

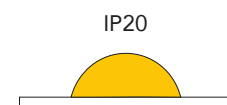

*NOTA:
Após descontinuação a fita COB Silene (13285171.11XX) terá como alternativa a fita SOB Cilene (13231421.14XX). | Tras la discontinuación de la cinta COB Cilene (13285171.11XXX), la alternativa será la cinta SOB Cilene (13231421.14XX).

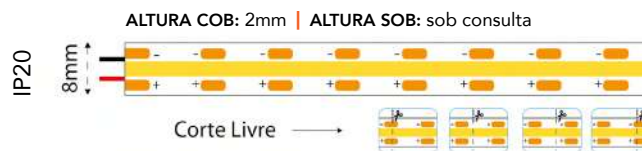

SUGESTÕES | SUGERENCIAS

Perfil Falco
Ref. PFA8731
Pág. 463

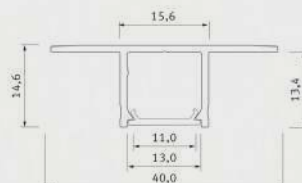

TURQUESA 11W IP20



EF+
11W/m
IP20
CRI 90
LED COB
480 LED/m
20Z
5m
CONEXÃO MÁXIMA 5m
DIMÁVEL
M M
CE
NOVO NUEVO

Modelo	Ref.	Efic.	Cor Color	Tensão Tensión	IP	Lumens /mt	Lumens /w
TURQUESA L70B50 36000H	13285461.1127	E	2700K	24V	IP20	1485Lm	135Lm
	13285461.1130	E	3000K	24V	IP20	1540Lm	140Lm
	13285461.1140	D	4000K	24V	IP20	1650Lm	150Lm
	13285461.1160	D	6500K	24V	IP20	1650Lm	150Lm

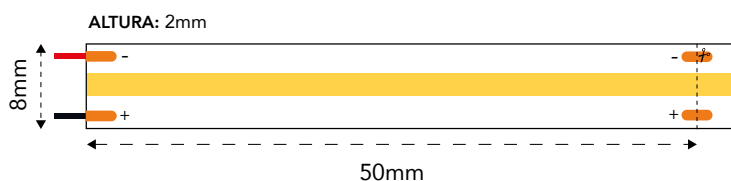
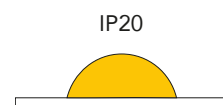

DESTAQUE | DESTACADO

FITA COB ALTA EFICIENCIA (150LM/W)
Tira COB de alta eficiencia (150LM/W)

SUGESTÕES | SUGERENCIAS

Perfil Tipo Z
ANODIZADO
Ref. PFA2191
Pág. 431



Difusor
SEMI-OPALINO
Ref. DF1SOE



Sensor Encastre
APROXIMAÇÃO
Ref. 06.04002
Pág. 57



Fonte Alimentação
SLIM/P 8 SAÍDAS
Ref. 05.01008
Pág. 61



FULL SPECTRUM 2000K-10000K IP20



24V DC
12W/m
IP20
CRI ≥90
2216 LED
336 LED/m
DIMÁVEL
M M
CE
NOVO NUEVO

Modelo	Ref.	Cor Color	Tensão Tensão	IP	Lumens /mt	Lumens /w
FULL SPECTRUM L80B10 50000H	13414481.12	2000K 10000K	24V	IP20	2220Lm	148Lm

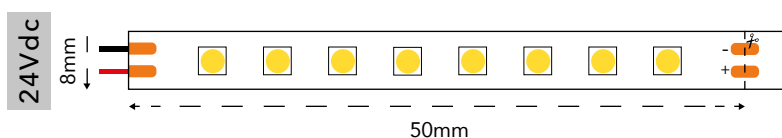
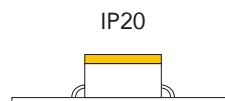

SUGESTÕES | SUGERENCIAS

Perfil Led Gemi ANODIZADO
Ref. PFA2751
Pág. 439

Difusor Semi-Opalino SEMI-OPALINO
Ref. DF3SOE

Fonte Alimentação 24V 120W IP20
Ref. 201561.2120
Pág. 267

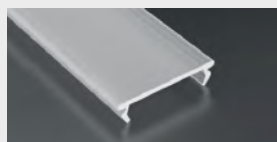

EUROPA 12W IP20



12W/m
IP20
20Z
2835 LED
60 LED/m
5m
CONEXÃO MÁXIMA 5m
DIMÁVEL
CRI 80
120°
M M
CE

Modelo	Ref.	Efic.	Cor Color	Tensão Tensión	IP	Lumens /mt	Lumens /W
EUROPA L70B50 36000H 3 Steps MacAdam	13011.1227	G	2700K	12V	IP20	1050Lm	88Lm
	13011.1230	G	3000K	12V	IP20	1100Lm	92Lm
	13011.1240	F	4000K	12V	IP20	1140Lm	95Lm
	13011.1260	F	6000K	12V	IP20	1200Lm	100Lm
	13041.1227	G	2700K	24V	IP20	1050Lm	88Lm
	13041.1230	G	3000K	24V	IP20	1100Lm	92Lm
EUROPA 50M L70B50 36000H	1301341.1227	G	2700K	24V	IP20	1030Lm	86Lm
	1301341.1230	G	3000K	24V	IP20	1120Lm	87Lm
	1301341.1240	G	4000K	24V	IP20	1060Lm	88Lm
	1301341.1260	G	6000K	24V	IP20	1200Lm	88Lm

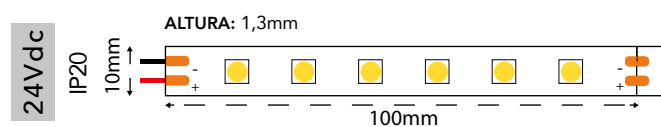
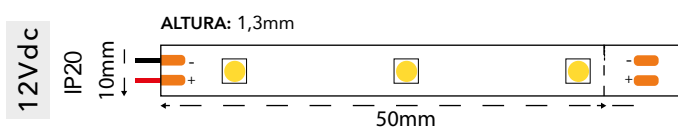
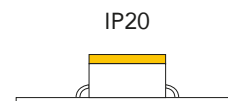

SUGESTÕES | SUGERENCIAS

Perfil Alcoutim
Ref. PFG23100
Pág. 427



Filtro de Proteção
12-48Vdc 5A 8A Cor Simples
Filtro de Protección Color Simple
Ref. 2238279.8192



EUROPA 12W IP65

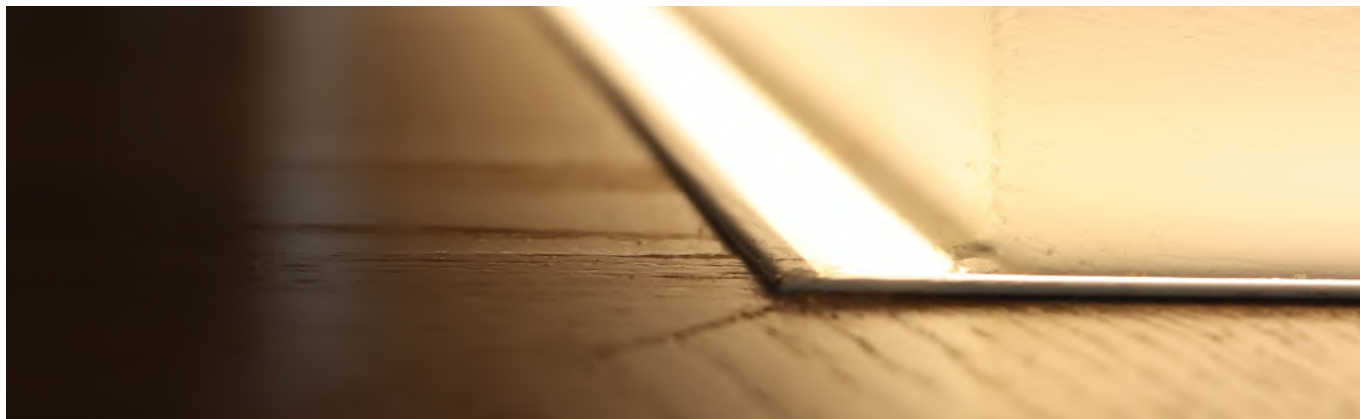

12W/m
IP65
20Z
2835 LED
60 LED/m
5m
CONEXÃO MÁXIMA 5m
DIMÁVEL
CRI 80
120°
M M
CE

Modelo	Ref.	Efic.	Cor Color	Tensão Tensión	IP	Lumens /mt	Lumens /W
EUROPA 65 L70B50 50000H	13015.1227	G	2700K	12V	IP65	980Lm	82Lm
	13015.1230	G	3000K	12V	IP65	1000Lm	83Lm
	13015.1240	G	4000K	12V	IP65	1086Lm	91Lm
	13015.1260	G	6000K	12V	IP65	1080Lm	90Lm
	13045.1227	G	2700K	24V	IP65	980Lm	82Lm
	13045.1230	G	3000K	24V	IP65	1000Lm	83Lm
	13045.1240	G	4000K	24V	IP65	1085Lm	90Lm
	13045.1260	G	6000K	24V	IP65	1085Lm	90Lm

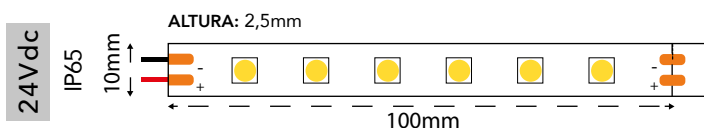
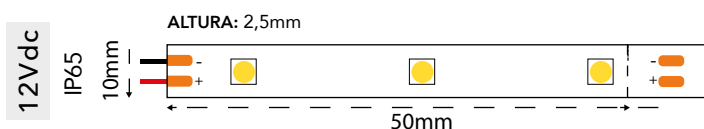
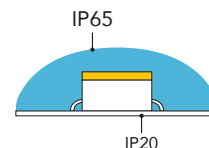

SUGESTÕES | SUGERENCIAS

Perfil Ansiães
Ref. PFG02032
Pág. 445



*Os modelos IP65 apresentam um fluxo luminoso (lumens) inferior aos modelos IP20 devido ao seu revestimento de silicone para proteção de sobre aquecimento.

*Los modelos IP65 tienen un flujo luminoso (Lúmenes) menor que los modelos IP20 debido a su revestimiento de silicona para proteger del sobrecalentamiento.

EUROPA 12W IP68



* ESTA FITA LED NÃO INCLUI FITA ADESIVA
Esta tira de led no incluye cinta adhesiva.



Modelo	Ref.	Efic.	Cor Color	Tensão Tensión	IP	Lumens /mt	Lumens /W
EUROPA 68	13017.1230	G	3000K	12V	IP68	1000Lm	83Lm
	13017.1240	G	4000K	12V	IP68	1085Lm	90Lm
	13017.1260	G	6000K	12V	IP68	1085Lm	90Lm
L70B50 50000H	13047.1230	G	3000K	24V	IP68	1000Lm	83Lm
	13047.1240	G	4000K	24V	IP68	1085Lm	90Lm
	13047.1260	G	6000K	24V	IP68	1085Lm	90Lm

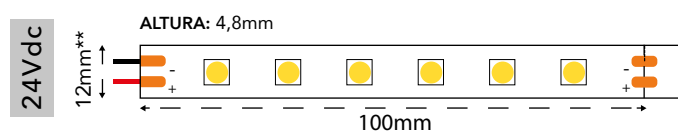
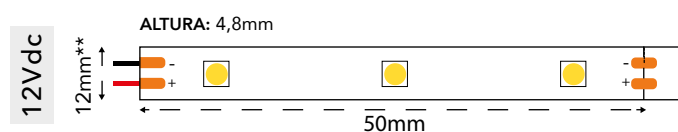
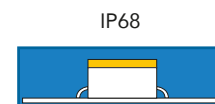

**Disponível também em 10mm
**También disponible en 10mm

*Os modelos IP68 não podem estar no ambiente aquático químico ou salobro.

*Los modelos IP68 no pueden estar en ambientes acuáticos químicos o salobros.

SUGESTÕES | SUGERENCIAS

Fonte Alimentação | Fuente Alimentación IP44
Ref. 201689.2100
Pág. 275



Filtro de Proteção Cor Simple 12-48Vdc 5A 8A
Filtro de Protección Color Simple
Ref. 2238279.8192



NOVA EUROPA 9,6W IP20



9,6W/m
IP20
CRI 90
20Z
2835 LED
128 LED/m
5m
CONEXÃO MÁXIMA 5m
DIMÁVEL
M M
CE
NOVO NUEVO

Modelo	Ref.	Efic.	Cor Color	Tensão Tensión	IP	Lumens /mt	Lumens /w
NOVA EUROPA	13401441.0927	E	2700K	24V	IP20	1248Lm	130Lm
	13401441.0930	E	3000K	24V	IP20	1325Lm	138Lm
	13401441.0940	E	4000K	24V	IP20	1373Lm	143Lm
L70B50 50000H	13401441.0960	E	6000K	24V	IP20	1373Lm	143Lm
	13401341.0927	E	2700K	24V	IP20	1248Lm	130Lm
NOVA EUROPA 50MT	13401341.0930	E	3000K	24V	IP20	1325Lm	138Lm
	13401341.0940	E	4000K	24V	IP20	1373Lm	143Lm
L70B50 50000H	13401341.0960	E	6000K	24V	IP20	1373Lm	143Lm

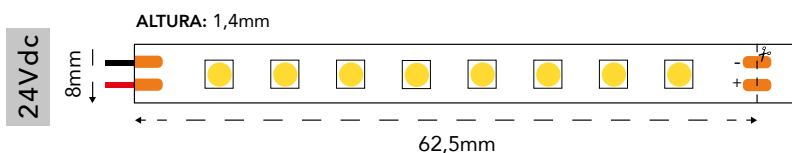
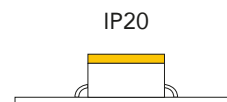

Alternativa às referências :13041.12XX e 1301341.12XX após descontinuação.
 Alternativa a las referencias 13041.12XX e 1301341.12XX después de la discontinuación.

ACESSÓRIOS RECOMENDADOS | ACCESORIOS RECOMENDADOS

<p>Perfil Tipo D Anodizado 2m Ref. PFA1191 Pág. 412</p>	<p>Controlador DIM 12-48Vdc Push DIM / Mesh 2.4G Ref. 2131218.6192 Pág. 362</p>	<p>Filtro de Proteção Cor Simples 12-48Vdc 5A 8A Filtro de Protección Color Simple Ref. 2238279.8192</p>
---	---	--

NOVA EUROPA 9,6W IP65 | IP67



9,6W/m | IP65 | IP67 | CRI 90 | 20Z | 2835 LED | 128 LED/m | 5m | CONEXÃO MÁXIMA 5m | DIMÁVEL | M M | CE | NOVO NUEVO

Modelo	Ref.	Efic.	Cor Color	Tensão Tensión	IP	Lumens /mt	Lumens /w
NOVA EUROPA IP65	13401445.0927	E	2700K	24V	IP65	1248Lm	130Lm
	13401445.0930	E	3000K	24V	IP65	1325Lm	138Lm
	13401445.0940	E	4000K	24V	IP65	1373Lm	143Lm
L70B50 50000H	13401445.0960	E	6000K	24V	IP65	1373Lm	143Lm
	13401447.0927	E	2700K	24V	IP67	1248Lm	130Lm
NOVA EUROPA IP67	13401447.0930	E	3000K	24V	IP67	1325Lm	138Lm
	13401447.0940	E	4000K	24V	IP67	1373Lm	143Lm
L70B50 50000H	13401447.0960	E	6000K	24V	IP67	1373Lm	143Lm

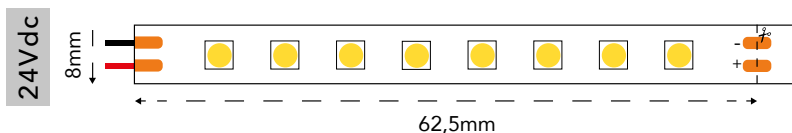
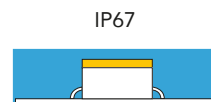
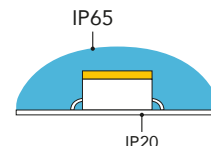

Alternativa às referências 13045.12XX e 13047.12XX após descontinuação.
 Alternativa a las referencias 13015.12XX e 13045.12XX después de la discontinuación.

ACESSÓRIOS RECOMENDADOS | ACCESORIOS RECOMENDADOS

<p>Perfil Alba Anodizado 2m Ref. PFA201001 Pág. 422</p> 	<p>Fonte VTS Eagle Rise 12Vdc 100W 8,33A IP67 Ref. 2018352.1100 Pág. 272</p> 	<p>Filtro de Proteção Cor Simples 12-48Vdc 5A 8A Filtro de Protección Color Simple Ref. 2238279.8192</p> 
---	--	---

_ FOBOS 14,4W IP20

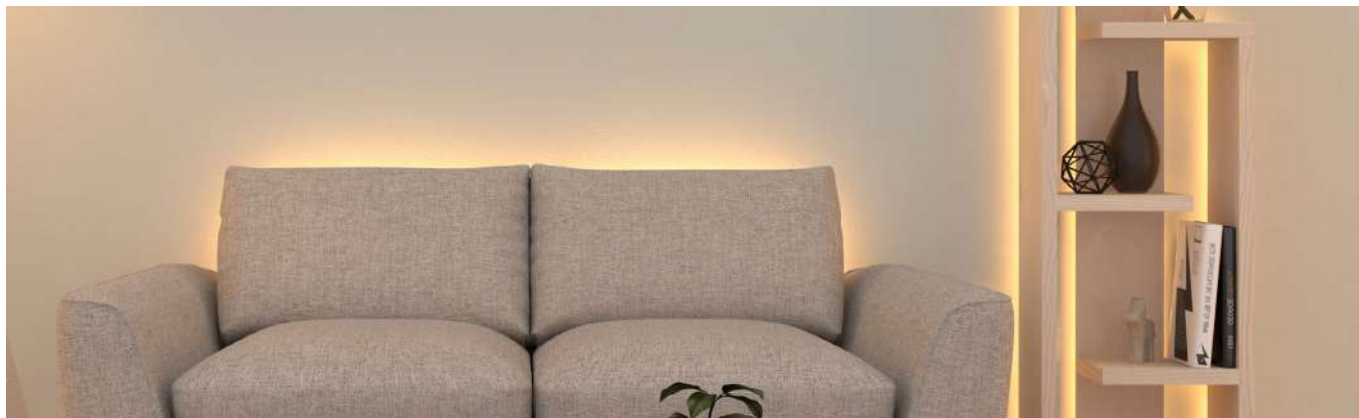

14,4W/m | IP20 | 30Z | 2835 LED | 120 LED/m | CONEXÃO MÁXIMA 10m | DIMÁVEL | CRI 80 | 120° | M M | CE

Modelo	Ref.	Efic.	Cor Color	Tensão Tensión	IP	Lumens /mt	Lumens /w
FOBOS	132151.1427	G	2700K	24V	IP20	1325Lm	102Lm
L70B50 36000H	132151.1430	F	3000K	24V	IP20	1370Lm	105Lm
3 Steps MacAdam	132151.1440	F	4000K	24V	IP20	1440Lm	100Lm
	132151.1460	F	6000K	24V	IP20	1440Lm	110Lm

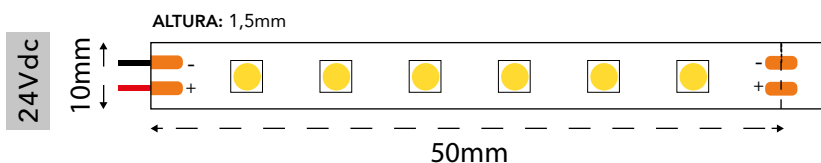
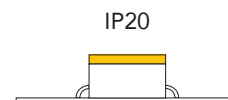

_ SUGESTÕES | SUGERENCIAS

Perfil Lagoinha 6mt
 Perfil de Lagoinha 6mt
 Ref. PFA8451.6
 Pág.456

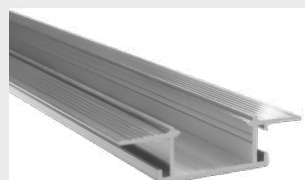

Filtro de Proteção
 12-48Vdc 5A 8A Cor Simples
 Filtro de Protección Color Simple
 Ref. 2238279.8192



DIFUSA OBERON 14,4W IP67



Modelo	Ref.	Cor Color	Tensão Tensión	IP	Lumens /mt	Lumens /w
OBERON	13237266.1427	2700K	24V	IP67	1065Lm	74Lm
L70B50 50000H	13237266.1430	3000K	24V	IP67	1094Lm	76Lm
5 Steps MacAdam	13237266.1440	4000K	24V	IP67	1152Lm	80Lm
	13237266.1460	6000K	24V	IP67	1152Lm	80Lm

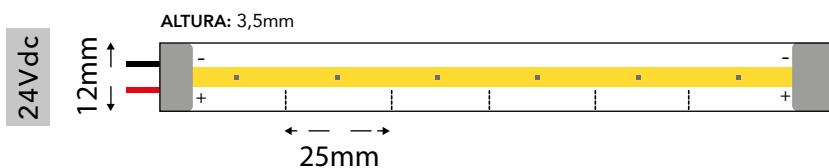
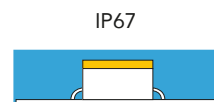

DESTAQUE | DESTACADO

Luz difusa, sem pontos de led visíveis
Luz difusa, sin puntos LED visibles

SUGESTÕES | SUGERENCIAS

Kit de acessórios disponível
Accesorios disponibles
Ref. 2221350.2

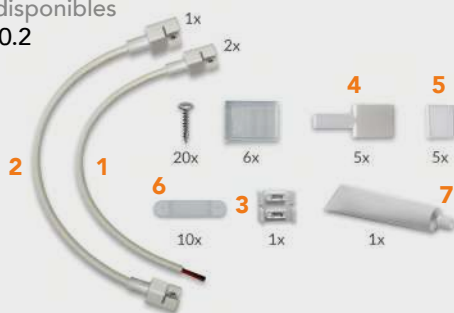

Acessórios disponíveis individualmente
Accesorios disponibles individualmente

- Conector c/cabo IP65
Conector c/cable IP65
Ref. 223252
- União c/cabo IP65
Uniones c/cable IP65
Ref. 223253
- União s/cabo IP65
Uniones s/cable IP65
Ref. 223251
- Topo c/furo
Tapa c/agujero
Ref. 22256
- Topo s/ furo
Tapa s/agujero
Ref. 22255
- Abraçadeiras transparentes c/ parafuso
Abrazaderas transparentes c/tornillo
Ref. 22257
- Silicone isolante
Silicona aislante
Ref. 22258

LUA 14,4W IP20 | IP65



14,4W/m | IP20 | IP65 | 20Z | 5050 SMD | 60 LED/m | 5m | CONEXÃO MÁXIMA 5m | DIMÁVEL | CRI 80 | 120° | M M | CE

Modelo	Ref.	Cor Color	Tensão Tensión	IP	Lumens /mt	Lumens /w
LUA L70B50 36000H 3 steps MacAdam	13011.1430	3000K	12V	IP20	1296Lm	90Lm
	13011.1440	4000K	12V	IP20	1368Lm	95Lm
	13011.1460	6000K	12V	IP20	1368Lm	95Lm
	13041.1430	3000K	24V	IP20	1296Lm	90Lm
	13041.1440	4000K	24V	IP20	1368Lm	95Lm
	13041.1460	6000K	24V	IP20	1368Lm	95Lm
LUA 65 L70B50 50000H	13015.1430	F 3000K	12V	IP65	1280Lm	89Lm
	13015.1440	G 4000K	12V	IP65	1356Lm	94Lm
	13015.1460	F 6000K	12V	IP65	1356Lm	94Lm
	13045.1430	G 3000K	24V	IP65	1280Lm	89Lm
	13045.1440	F 4000K	24V	IP65	1356Lm	94Lm
	13045.1460	F 6000K	24V	IP65	1356Lm	94Lm

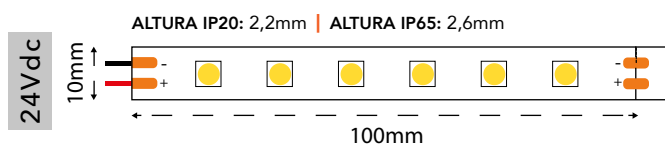
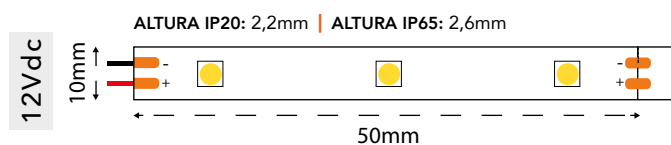
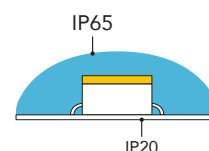

SUGESTÕES | SUGERENCIAS

Controlador Dimmer cor simples 1 canal c/ 96W
Ref. 211218.196
Pág. 329



_Controlador ideal para controlar fitas LED de 12Vdc e 24Vdc, até uma potência máxima de 96W (12Vdc) e 192W (24Vdc);

_Este permite ser controlado por rádiofrequência e push.

_Controlador ideal para controlar tiras LED de 12Vdc y 24Vdc, hasta una potencia máxima de 96W (12Vdc) y 192W (24Vdc);

_Puede ser controlado por radiofrecuencia y pulsador.

PERDITA 14,4W IP20

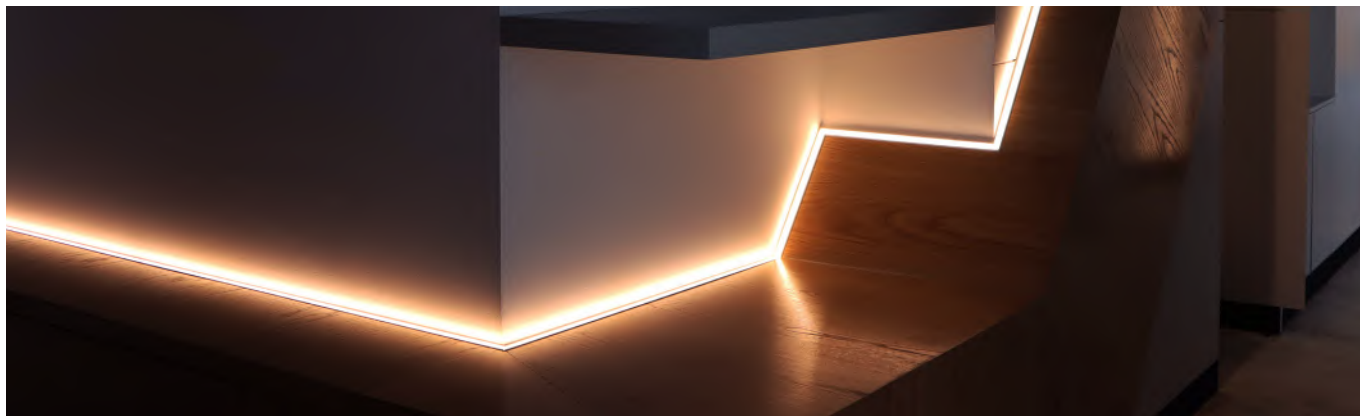

14,4W/m | IP20 | 30Z | 2216 SMD | 210 LED/m | 5m | CONEXÃO MÁXIMA 5m | DIMÁVEL | CRI 90 | 120° | M M | CE

Modelo	Ref.	Efic.	Cor Color	Tensão Tensión	IP	Lumens /mt	Lumens /w
	13821.1424		2400K	24V	IP20	1152Lm	92Lm
PERDITA L70B50 36000H 5 Steps MacAdam	13821.1427	G	2700K	24V	IP20	1340Lm	93Lm
	13821.1430	G	3000K	24V	IP20	1360Lm	94Lm
	13821.1440	F	4000K	24V	IP20	1497Lm	104Lm

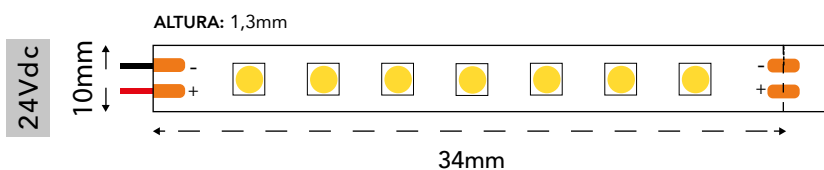
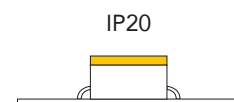

SUGESTÕES | SUGERENCIAS

Perfil Penegache
Ref. PFA2461
Pág. 438

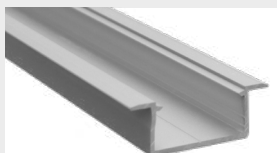

Filtro de Proteção
12-48Vdc 5A 8A Cor Simples
Filtro de Protección Color Simple
Ref. 2238279.8192



PROSPERO 14,4W IP20



14,4W m	IP20	30Z	2835 LED	80 LED/m	1800 Lm/m	125 Lm/W	5m	CONEXÃO MÁXIMA 5m	DIMÁVEL	CRI >90	120°	M M	CE
------------	------	-----	-------------	-------------	--------------	-------------	----	-------------------------	---------	------------	------	-----	----

Modelo	Ref.	Efic.	Cor Color	Tensão Tensión	IP	Lumens /mt	Lumens /w
PROSPERO L70B10 50000H	1320621.1427	E	2700K	24V	IP20	1960Lm	136Lm
	1320621.1430	E	3000K	24V	IP20	2000Lm	139Lm
	1320621.1440	D	4000K	24V	IP20	2000Lm	139Lm

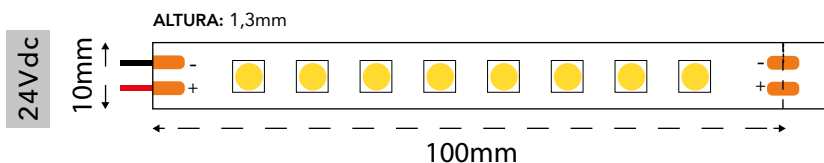
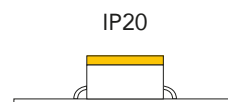

SUGESTÕES | SUGERENCIAS

Perfil Lagoinha
Ref. PFA8451
Pág. 456



Filtro de Proteção
12-48Vdc 5A 8A Cor Simples
Filtro de Protección Color Simple
Ref. 2238279.8192





A iluminação led é integrada de forma discreta na arquitetura do espaço. As linhas contínuas de led embutidas, que acompanham os recortes geométricos da laje das escadas e do vão superior, criam um efeito de luz indireta e uniforme. Essa iluminação linear valoriza os planos e a profundidade do espaço.

La iluminación LED se integra discretamente en la arquitectura del espacio. Las líneas continuas de LED empotradas, que siguen los recortes geométricos de la losa de las escaleras y del hueco superior, crean un efecto de luz indirecta y uniforme. Esta iluminación lineal realza los planos y la profundidad del espacio.

CSP E SOB TARVOS 14,4W IP20

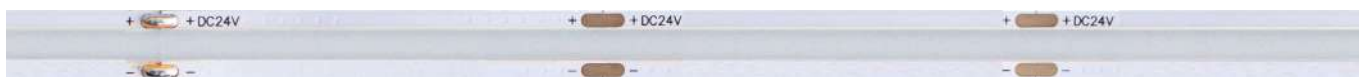

Modelo	Ref.	Efic.	Cor Color	Tensão Tensión	IP	Lumens /mt	Lumens /w
CSP TARVOS	13281241.1427	G	2700K	24V	IP20	1300Lm	90Lm
	13281241.1430	F	3000K	24V	IP20	1230Lm	92Lm
	13281241.1440	F	4000K	24V	IP20	1360Lm	94Lm
	13281241.1460	F	6000K	24V	IP20	1340Lm	93Lm
SOB TARVOS	13231441.1427	-	2700K	24V	IP20	1368Lm	95Lm
	13231441.1430	-	3000K	24V	IP20	1397Lm	97Lm
	13231441.1440	-	4000K	24V	IP20	1469Lm	102Lm
	13231441.1460	-	6000K	24V	IP20	1440Lm	100Lm

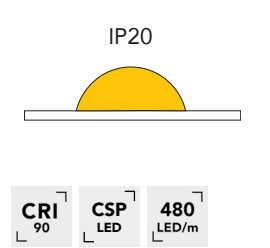

*NOTA:
Após descontinuação a fita CSP Tarvos (13281241.14XX) terá como alternativa a fita SOB Tarvos (13231441.14XX).
Tras la discontinuación de la cinta CSP Tarvos (13281241.14XX), la alternativa será la cinta SOB Tarvos (13231441.14XX).

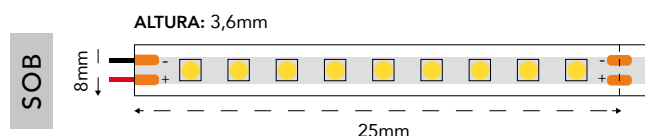
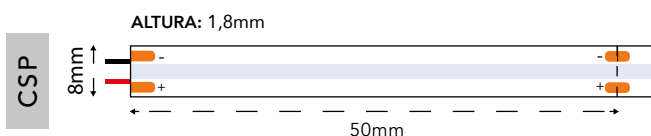

SUGESTÕES | SUGERENCIAS

Fonte 2 em 1
Fuente 2 en 1
Ref. 2021881.2150
Pág. 280



Filtro de Proteção
12-48Vdc 5A 8A Cor Simples
Filtro de Protección Color Simple
Ref. 2238279.8192



GALATEIA 14,4W IP20

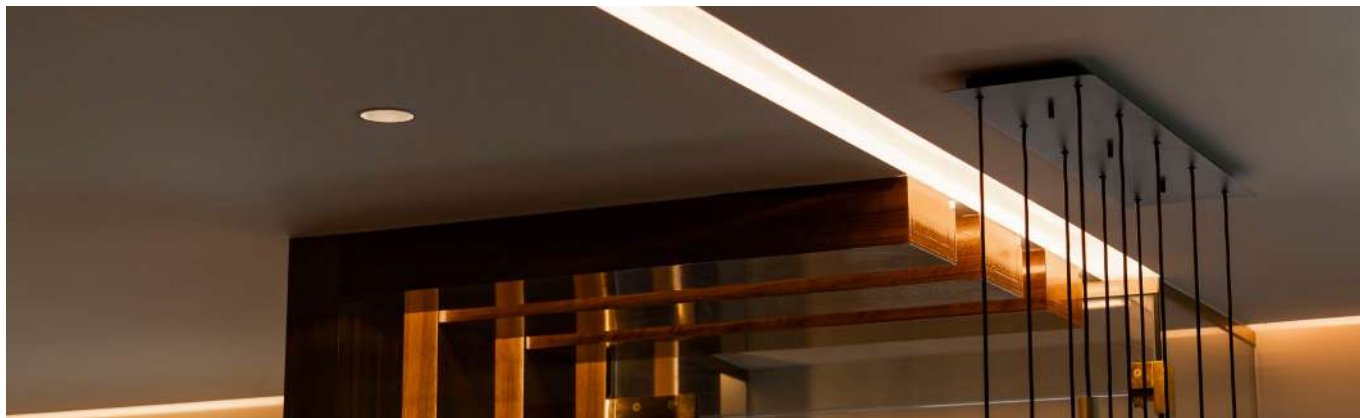

EF+
14,4W/m
IP20
20Z
2835 SMD
160 LED/m
2230 Lm/m
155 Lm/W
5m
CONEXÃO MÁXIMA 5m
DIMÁVEL
CRI 80
M M
CE

Modelo	Ref.	Efic.	Cor Color	Tensão Tensión	IP	Lumens /mt	Lumens /w	
GALATEIA	1311121.1427	E	2700K	24V	IP20	1930Lm	134Lm	
	1311121.1430	E	3000K	24V	IP20	2080Lm	144Lm	
	L70B50 50000H	D	4000K	24V	IP20	2160Lm	150Lm	
	1311121.1460	D	6000K	24V	IP20	2230Lm	155Lm	
GALATEIA 50M	13111341.1427	E	2700K	24V	IP20	1930Lm	134Lm	
	13111341.1430	E	3000K	24V	IP20	2080Lm	144Lm	
	L70B50 50000H	D	4000K	24V	IP20	2160Lm	150Lm	
	13111341.1460	D	6000K	24V	IP20	2230Lm	155Lm	

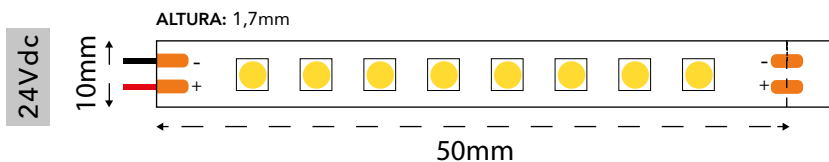

SUGESTÕES | SUGERENCIAS

Controlador 1 Canal 5A
Ref. 2127258.4120
Pág. 369



Filtro de Proteção
12-48Vdc 5A 8A Cor Simples
Filtro de Protección Color Simple
Ref. 2238279.8192



MIRANDA 14,4W IP20



Modelo	Ref.	Cor Color	Tensão Tensión	IP	Numens
MIRANDA	1323191.14RGB	RGB	24V	IP20	R: 625Nm G: 532Nm B: 475Nm

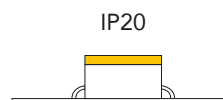
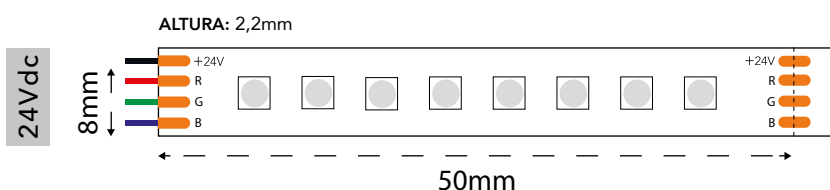

SUGESTÕES | SUGESTÕES

Perfil Tipo X | Ref. PFA1111
Pág. 411

Perfil Tipo A

Perfil Tipo X



Filtro de Proteção 12-48Vdc 5A RGBW
Filtro de Protección 12-48Vdc 5A RGBW
Ref. 2238278.8120



Devido à largura de 8 mm a fita é ideal para aplicações mais reduzidas e para aplicar em perfis de menores dimensões, como por exemplo o perfil Xangai.

Debido a su ancho de 8 mm, la tira es ideal para aplicaciones más pequeñas y para aplicar en perfiles más pequeños, como el perfil Xangai.

MARGARET 14,4W IP20 | IP65 | IP68



* ESTA FITA LED NÃO INCLUI FITA ADESIVA
Esta tira de led no incluye cinta adhesiva.

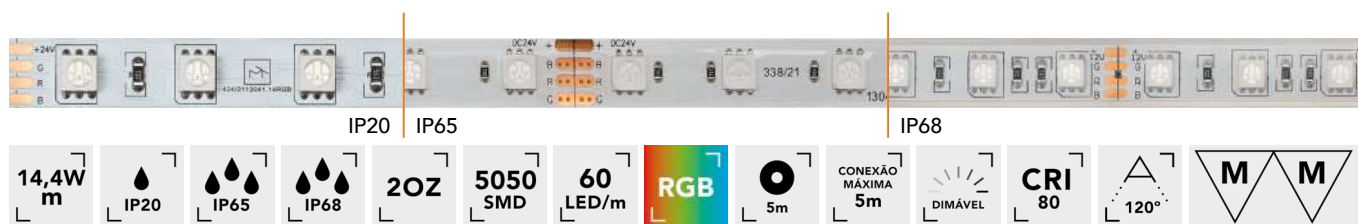

14,4W/m | IP20 | IP65 | IP68 | 20Z | 5050 SMD | 60 LED/m | RGB | 5m | CONEXÃO MÁXIMA 5m | DIMÁVEL | CRI 80 | 120° | M M



Modelo	Ref.	Cor Color	Tensão Tensión	IP	Numens
MARGARET L70B50 36000H	9W 13041.09VM	Vermelho Rojo	24V	IP20	625Nm
	12W 13041.12AZ	Azul	24V	IP20	475Nm
	14,4W 13011.14VD	Verde	12V	IP20	532Nm
MARGARET	13011.14RGB	RGB	12V	IP20	
	13041.14RGB	RGB	24V	IP20	
MARGARET 65	13015.14RGB	RGB	12V	IP65	
	13045.14RGB	RGB	24V	IP65	
MARGARET 68	13017.14RGB	RGB	12V	IP68	

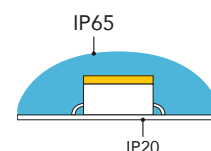
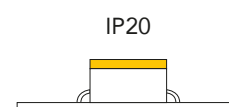

R: 625Nm
G: 532Nm
B: 475Nm

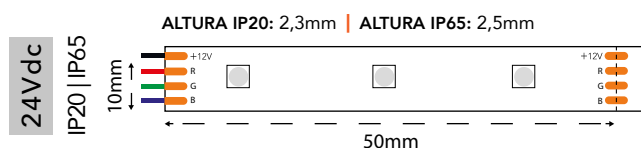

HELENE 14,4W IP20 | IP68



* ESTA FITA LED NÃO INCLUI FITA ADESIVA
Esta tira de led no incluye cinta adhesiva.



14,4W/m | IP20 | IP68 | 20Z | 5050 SMD | 60 LED/m | RGB | 10m | CONEXÃO MÁXIMA 20m | DIMÁVEL | CRI 80 | 120° | M M | CE

Modelo	Ref.	Cor Color	Tensão Tensión	IP	Numens
HELENE	13051.14RGB	RGB	24V	IP20	R: 625Nm G: 532Nm B: 475Nm
HELENE 68	13057.14RGB	RGB	24V	IP68	

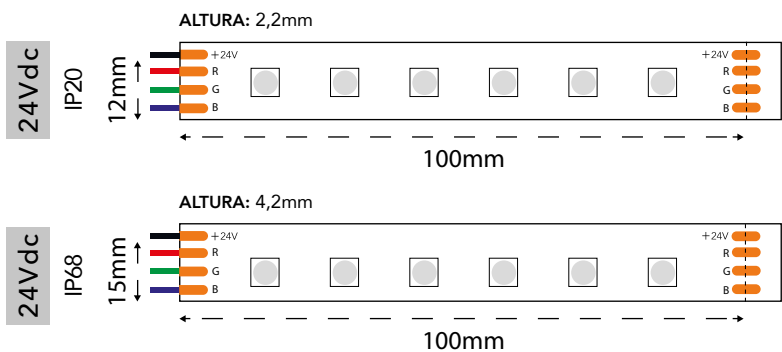
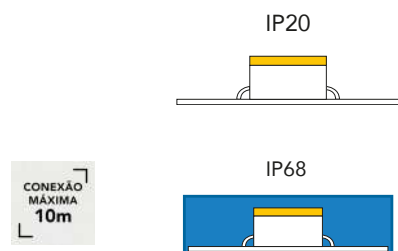

SUGESTÕES | SUGERENCIAS

CONTROLO POR WIFI: | CONTROL WIFI:

Controlador RGB+W
Ref. 211243.4480
Pág. 333

Antena Wifi/RF
Ref. 218244

Comando RF 1 Zona
Controlo RGB+W
Ref. 2120244.RGBW
Pág. 334

Filtro de Proteção
Filtro de Protección
12-48Vdc 5A RGBW
Ref. 2238278.8120



DIONE 14,4W IP20 | IP67

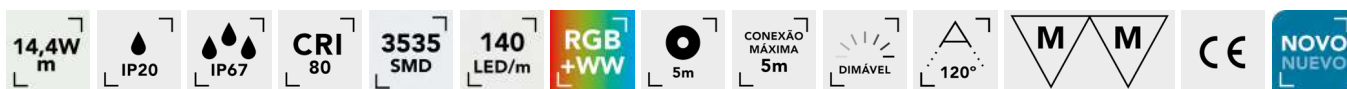

Modelo	Ref.	Cor Color	Tensão Tensão	IP	Lumens/Numens
DIONE	1315321.14RGB+27	RGB + 2700K	24V	IP20	R: 105Nm G: 330Nm B: 67Nm 2700K: 270Lm/mt
	1315321.14RGB+40	RGB + 4000K	24V	IP20	R: 105Nm G: 330Nm B: 67Nm 4000K: 320Lm/mt
DIONE 67	1315326.14RGB+30	RGB + 3000K	24V	IP67	RGB + 3000K: 700Nm
	1315326.14RGB+40	RGB + 4000K	24V	IP67	RGB + 4000K: 750Nm

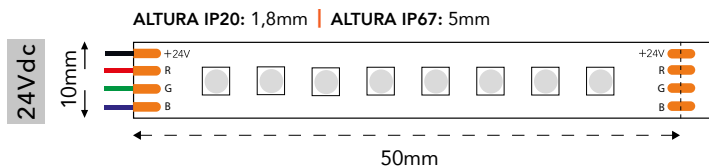
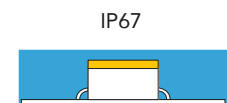
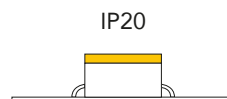

SUGESTÕES | SUGERENCIAS

IP20			IP67	
Perfil Andorra ANODIZADO Ref. PFA111 Pág. 413	Amplificador RGB+W Ref. 216217.4480 Pág. 395	Controlador DIM/CCT/RGBW/RGB+CCT Ref. 2131224.4384 Pág. 362	Topo S/Furo OBÉRON Ref. 22255	Perfil Gemi ANODIZADO Ref. PFA2751 Pág. 439

HIMALIA 14,4W IP67



14,4W/m | IP67 | 2835 SMD | 160 LED/m | 5m | CONEXÃO MÁXIMA 5m | 120° | DIMÁVEL | CRI 80 | M M | CE

Modelo	Ref.	Efic.	Cor Color	Tensão Tensión	IP	Lumens /mt	Lumens /w
	1312126.1427	E	2700K	24V	IP67	1800Lm	125Lm
HIMALIA	1312126.1430	E	3000K	24V	IP67	1720Lm	120Lm
L70B50 36000H	1312126.1440	E	4000K	24V	IP67	1900Lm	132Lm
	1312126.1460	E	6000K	24V	IP67	1900Lm	132Lm

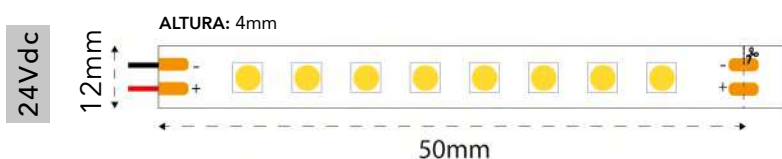
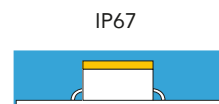

SUGESTÕES | SUGERENCIAS

Fonte de alimentação IP67 VTS
Fuente de alimentación IP67 VTS
Ref. 2018352.2100
Pág. 272



Filtro de Proteção 12-48Vdc 5A 8A Cor Simples
Filtro de Protección Color Simple
Ref. 2238279.8192



AEGIR 14,4W IP68

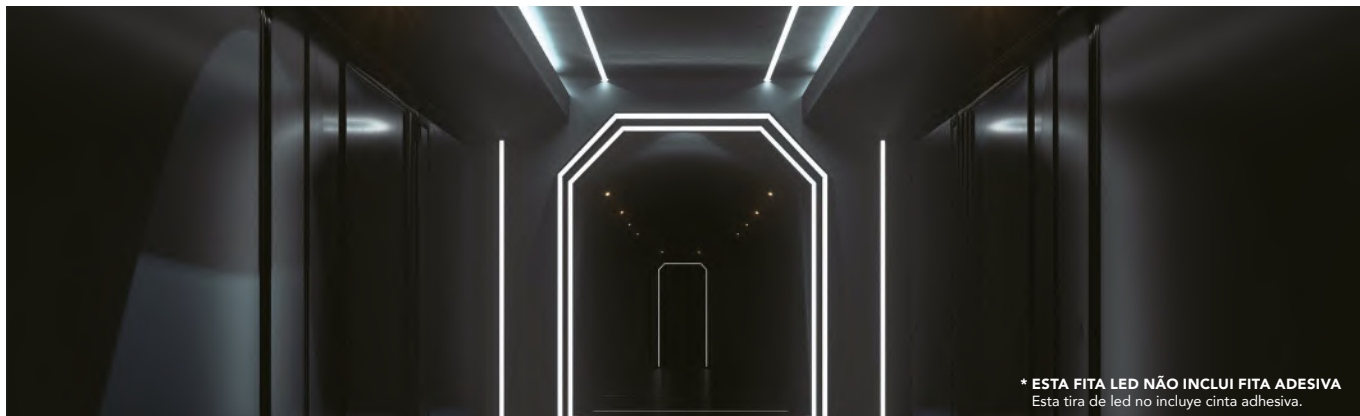

* ESTA FITA LED NÃO INCLUI FITA ADESIVA
Esta tira de led no incluye cinta adhesiva.



14,4W/m | IP68 | 30Z | 2835 SMD | 126 LED/m | 10m | CONEXÃO MÁXIMA 10m | DIMÁVEL | CRI 80 | 120° | M M | CE

Modelo	Ref.	Efic.	Cor Color	Tensão Tensión	IP	Lumens /mt	Lumens /w
AEGIR L70B50 36000H	1312157.1430	F	3000K	24V	IP68	1650Lm	115Lm
	1312157.1440	E	4000K	24V	IP68	1850Lm	128Lm
	1312157.1460	E	6000K	24V	IP68	1780Lm	124Lm

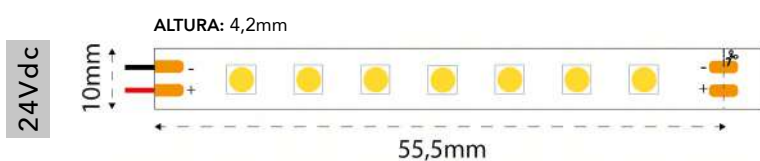
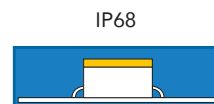

SUGESTÕES | SUGERENCIAS

Difusor em rolo*
Difusor en rollo*
Pág. 402



Filtro de Proteção
12-48Vdc 5A 8A Cor Simples
Filtro de Protección Color Simple
Ref. 2238279.8192



*Consiga uma linha de luz contínua com o nosso difusor em rolo de 50mt.

*Consiga una línea continua de luz con nuestro difusor en rollo de 50mt.

TITÃ 15W IP20



5 mm | 15W/m | IP20 | 30Z | 2835 SMD | 120 LED/m | 5m | CONEXÃO MÁXIMA 5m | DIMÁVEL | CRI 80 | 120° | M M | CE

Modelo	Ref.	Efic.	Cor Color	Tensão Tensión	IP	Lumens /mt	Lumens /w
TITÃ L70B10 50000H 5 Steps MacAdam	13291.1530	F	3000K	24V	IP20	1410Lm	94Lm
	13291.1540	F	4000K	24V	IP20	1440Lm	96Lm
	13291.1560	F	6000K	24V	IP20	1430Lm	95Lm

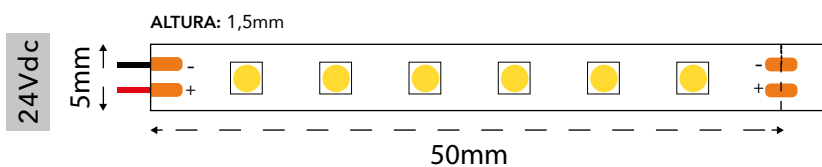
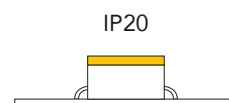

SUGESTÕES | SUGERENCIAS

Perfil Penedono
Ref. PFD0181
Pág. 410



Filtro de Proteção
12-48Vdc 5A 8A Cor Simples
Filtro de Protección Color Simple
Ref. 2238279.8192



CUPIDO 15W IP20



15W/m | IP20 | 20Z | 2110 LED | 238 LED/m | 5m CONEXÃO MÁXIMA | DIMÁVEL | CRI 90 | 120° | M M | CE

Modelo	Ref.	Cor Color	Tensão Tensión	IP	Lumens /mt	Lumens /w
CUPIDO L70B50 36000H 5 Steps MacAdam	1310221.1518	1800K	24V	IP20	870Lm	58Lm
	1310221.1522	2200K	24V	IP20	900Lm	60Lm
	1310221.1525	2500K	24V	IP20	930Lm	62Lm

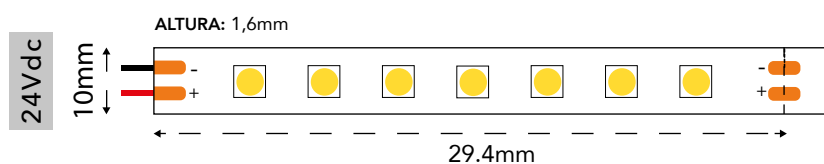
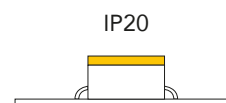

DESTAQUE | DESTACADO

Temperaturas: 1800K | 2200K | 2500K

As fitas de led com temperaturas de 1800K | 2200K | 2500K são ideais para criar uma luz de ambiente vintage e indicadas para a aplicação em ambientes de restauração.

Tiras LED con temperaturas de 1800K | 2200K | 2500K son ideales para crear luz ambiental vintage y aptas para su aplicación en ambientes de restaurante.

SUGESTÕES | SUGERENCIAS

Controlador 1 Canal 5A
Ref. 2127258.4120
Pág. 369



Filtro de Proteção
12-48Vdc 5A 8A Cor Simples
Filtro de Protección Color Simple
Ref. 2238279.8192



PROTEU 15W IP20



15W/m
IP20
20Z
2216 SMD
280 LED/m
5m
CONEXÃO MÁXIMA 5m
DIMÁVEL
CRI 90
120°
M M
CE

Modelo	Ref.	Efic.	Cor Color	Tensão Tensión	IP	Lumens /mt	Lumens /w
PROTEU	1323421.1527	F	2700K	24V	IP20	1560Lm	104Lm
L70B50 36000H	1323421.1530	F	3000K	24V	IP20	1605Lm	107Lm
5 Steps MacAdam	1323421.1540	F	4000K	24V	IP20	1640Lm	110Lm

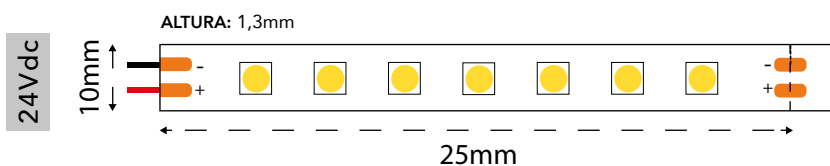
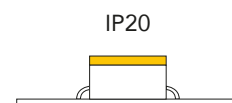

SUGESTÕES | SUGERENCIAS

Perfil Apa 12
Ref. PFA841
Pág. 471



Filtro de Proteção
12-48Vdc 5A 8A Cor Simples
Filtro de Protección Color Simple
Ref. 2238279.8192



POLIDEUCES 15W IP20



15W/m
IP20
30Z
2835 SMD
140 LED/m
5m
CONEXÃO MÁXIMA 5m
DIMÁVEL
CRI 80
120°
M M
CE

Modelo	Ref.	Efic.	Cor Color	Tensão Tensión	IP	Lumens /mt	Lumens /w
POLIDEUCES L70B50 50000H 3 Steps MacAdam	131521.1527	F	2700K	24V	IP20	1460Lm	97Lm
	131521.1530	F	3000K	24V	IP20	1480Lm	99Lm
	131521.1540	F	4000K	24V	IP20	1560Lm	104Lm
	131521.1550	F	5000K	24V	IP20	1560Lm	104Lm
	131521.1560	F	6500K	24V	IP20	1560Lm	104Lm

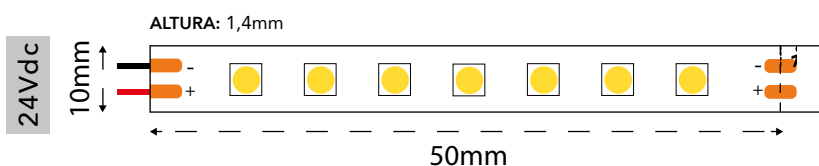
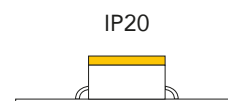

SUGESTÕES | SUGERENCIAS

Controlador dimmer
RF+Wifi+Push Nexta
Ref. 2127258.4240
Pág. 369



_ Controlador ideal para controlar fitas LED de 12Vdc e 24Vdc, até uma potência máxima de 120W (12Vdc) e 240W (24Vdc);

_ Este permite ser controlado por Wifi, RF e push.

_ Controlador ideal para controlar tiras LED de 12Vdc y 24Vdc, hasta una potencia máxima de 120W (12Vdc) y 240W (24Vdc);

_ Este permite ser controlado por Wifi, RF y push.

POLIDEUCES 15W IP54 | IP65



Modelo	Ref.	Efic.	Cor Color	Tensão Tensão	IP	Lumens /mt	Lumens /W
POLIDEUCES 54 L70B10 50000H 5 Steps MacAdam	13324.1527	E	2700K	24V	IP54	2100Lm	140Lm
	13324.1530	E	3000K	24V	IP54	2160Lm	144Lm
	13324.1540	D	4000K	24V	IP54	2240Lm	149Lm
POLIDEUCES 65 L70B50 36000H 3 Steps MacAdam	131525.1527	F	2700K	24V	IP65	1440Lm	96Lm
	131525.1530	F	3000K	24V	IP65	1460Lm	97Lm
	131525.1540	F	4000K	24V	IP65	1480Lm	99Lm
	131525.1560	F	6500K	24V	IP65	1560Lm	104Lm

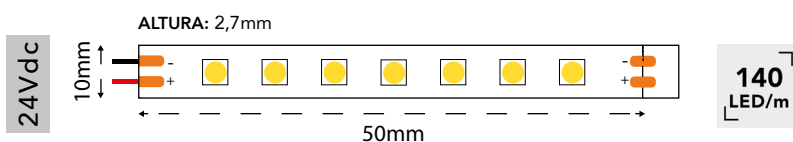
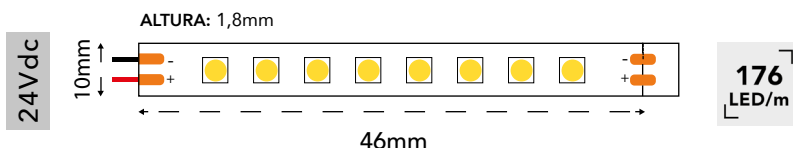
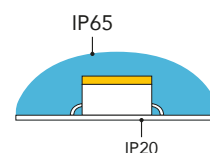

SUGESTÕES | SUGERENCIAS

Controlador dimmer
RF+Wifi+Push Nexta
Ref. 2127258.4240
Pág. 369



Filtro de Proteção
12-48Vdc 5A 8A Cor Simples
Filtro de Protección Color Simple
Ref. 2238279.8192



NOVA POLIDEUCES 15W IP20



15W/m
24V DC
IP20
CRI 90
2835 LED
160 LED/m
5m
CONEXÃO MÁXIMA 5m
DIMÁVEL
M M
CE
NOVO NUEVO

Modelo	Ref.	Efic.	Cor Color	Tensão Tensión	IP	Lumens /mt	Lumens /w
NOVA POLIDEUCES L80B10 50000H	13111461.1527		2700K	24V	IP20	2220Lm	148Lm
	13111461.1530		3000K	24V	IP20	2250Lm	150Lm
	13111461.1540		4000K	24V	IP20	2295Lm	153Lm
	13111461.1560		6500K	24V	IP20	2295Lm	153Lm

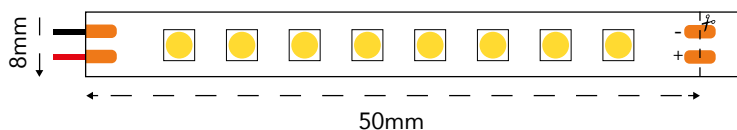
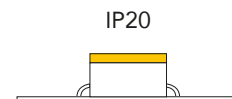

SUGESTÕES | SUGERENCIAS

Perfil Andorra
Ref. PFA111
Pág. 413



Controlador Mini Dim
Push RF/WiFi 12-48V
Ref. 2130218.6144
Pág. 339



CRÉSSIDA 15W IP20 | IP54

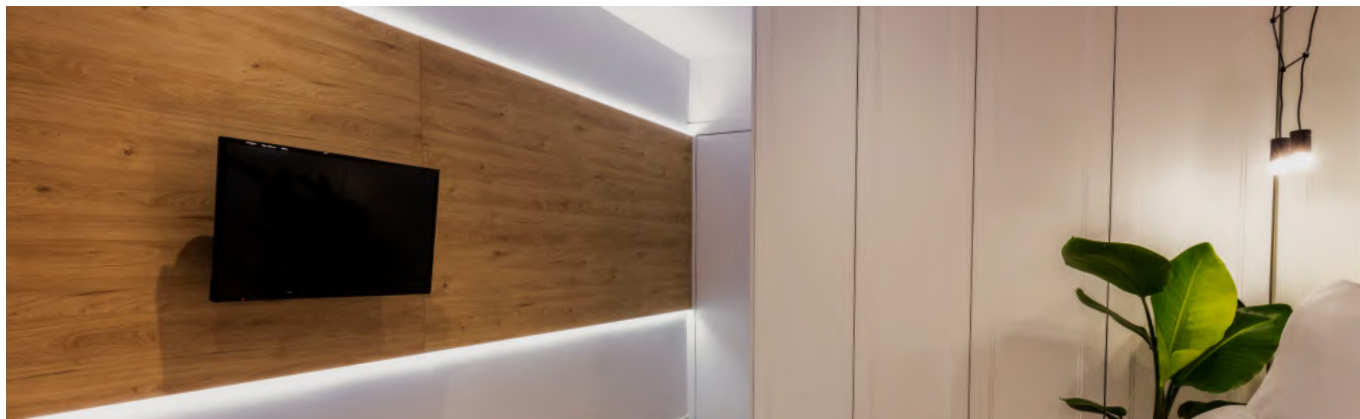

Modelo	Ref.	Efic.	Cor Color	Tensão Tensión	IP	Lumens /mt	Lumens /w
CRÉSSIDA L70B50 50000H	13251.1527	E	2700K	24V	IP20	2050Lm	134Lm
	13251.1530	E	3000K	24V	IP20	2115Lm	141Lm
	13251.1540	D	4000K	24V	IP20	2205Lm	147Lm
	13251.1560	D	6000K	24V	IP20	2060Lm	147Lm
CRÉSSIDA 54 L70B50 50000H	13254.1527	E	2700K	24V	IP54	1880Lm	125Lm
	13254.1530	E	3000K	24V	IP54	1950Lm	130Lm
	13254.1540	E	4000K	24V	IP54	2175Lm	145Lm
	13254.1560	E	6000K	24V	IP54	2175Lm	145Lm

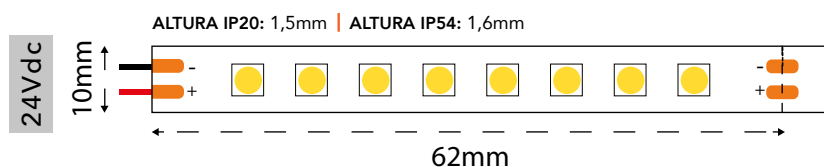

Estas fitas poderão ser ligadas com 10mt com uma única ligação de 24Vdc.

Estas tiras se pueden conectar 20mt con una sola conexión de 24Vdc.

SUGESTÕES | SUGERENCIAS

Fonte HLG-320-24
Fuente HLG-320-24
Ref. 203146.2320
Pág. 277



Filtro de Proteção
12-48Vdc 5A 8A Cor Simples
Filtro de Protección Color Simple
Ref. 2238279.8192



COB E CSP CALIQUE 15W | 18W IP20



Modelo	Ref.	Cor Color	Tensão	IP	Numens
COB CALIQUE	1329541.15RGB	RGB	24V	IP20	R: 127Nm G: 580Nm B: 70Nm
CSP CALIQUE	13291241.15RGB*	RGB	24V	IP20	R: 782Nm G: 150Nm B: 575Nm
COB CALIQUE	1329541.18RGBW	RGB + 6000K	24V	IP20	R: 120Nm G: 531Nm B: 86Nm 6000K: 489Nm

15W/m

15W/m

18W/m

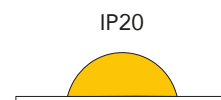

*NOTA: Alternativa à referência 1329541.15RGB após descontinuação.
Alternativa a la referencia 1329541.15RGB después de la discontinuación.

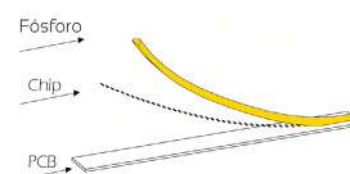
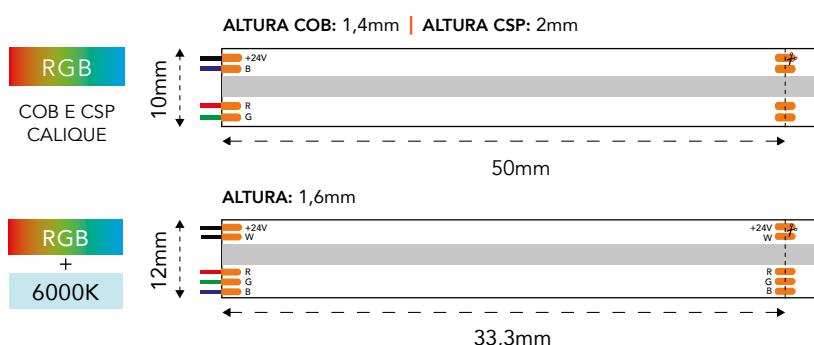

SUGESTÕES | SUGERENCIAS

Controlador RGB com Comando | con Mando
Ref. 212217.1180
Pág. 334

O comando pode controlar até 100 controladores por programação. | El mando puede controlar hasta 100 controladores por programación.



Filtro de Proteção
Filtro de Protección
12-48Vdc 5A RGBW
Ref. 2238278.8120



ORTÓSIA 230V 15W IP65



15W/m
IP65
2835 SMD
120 LED/m
CONEXÃO MÁXIMA 50m
CORTE: 5CM
DIMÁVEL
CRI 80
CE

Modelo	Ref.	Cor Color	Tensão Tensión	IP	Lumens /mt	Lumens /w
ORTÓSIA 50MT	132136.1527	2700K	230V	IP65	1350Lm	90Lm
	132136.1530	3000K	230V	IP65	1380Lm	92Lm
	132136.1540	4000K	230V	IP65	1410Lm	94Lm
	132136.1560	6000K	230V	IP65	1440Lm	96Lm
ORTÓSIA 20MT	132138.1527	2700K	230V	IP65	1350Lm	90Lm
	132138.1530	3000K	230V	IP65	1380Lm	92Lm
	132138.1540	4000K	230V	IP65	1410Lm	94Lm
	132138.1560	6000K	230V	IP65	1440Lm	96Lm

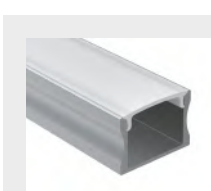
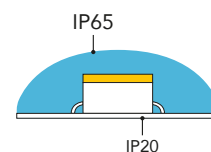

Perfil NISA Ref. PFA1831



Perfil AVIS Ref. PFA1841

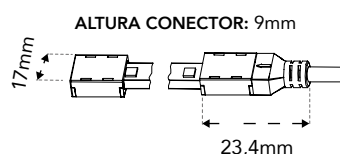
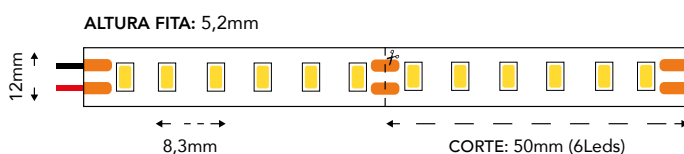

SUGESTÕES | SUGERENCIAS

<p>Cabo c/ fusível p/ cravar Cable con fusible para engarzar Ref. 223713</p>	<p>União de cravar ligação rápida Unión de engarce de conexión rápida Ref. 223123</p>	<p>Topo com furo Tapa com pasacable Ref. 2229764</p>	<p>Topo sem furo Tapa sin pasacable Ref. 2230764</p>	<p>Silicone isolante Silicona aislante Ref. 22258.100</p>
--	---	--	--	---

COB CALICORE 15W IP65



Modelo	Ref.	Efic.	Cor Color	Tensão Tensão	IP	Lumens /mt	Lumens /w
COB CALICORE 50000H 6 Steps MacAdam	1328525.1527		2700K	24V	IP65	1605Lm	107Lm
	1328525.1530		3000K	24V	IP65	1725Lm	115Lm
	1328525.1540	G	4000K	24V	IP65	1875Lm	125Lm
	1328525.1560	F	6500K	24V	IP65	1800Lm	120Lm

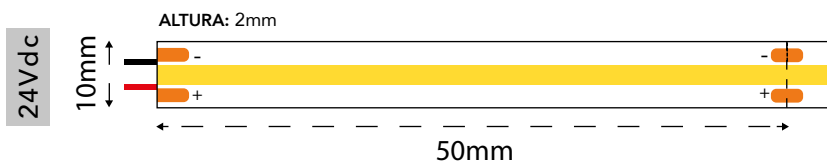
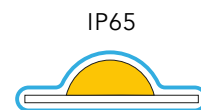

SUGESTÕES | SUGERENCIAS

Perfil Monsaraz
Ref. PFD5361
Pág. 447



Filtro de Proteção
12-48Vdc 5A 8A Cor Simples
Filtro de Protección Color Simple
Ref. 2238279.8192



HIGH CORÉ 16W IP20



EF+
16W/m
IP20
2835 SMD
200 LED/m
5m
CONEXÃO MÁXIMA 5m
DIMÁVEL
CRI 90
120°
M M
CE

Modelo	Ref.	Cor Color	Tensão Tensão	IP	Lumens /mt	Lumens /w
HIGH CORÉ L80B10 50000H	13371411.1627	2700K	24V	IP20	1700Lm	106Lm
	13371411.1630	3000K	24V	IP20	1814Lm	113Lm
	13371411.1640	4000K	24V	IP20	2040Lm	128Lm
	13371411.1660	6000K	24V	IP20	2040Lm	128Lm

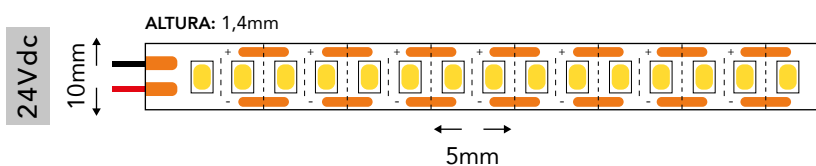
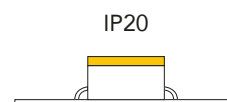

SUGESTÕES | SUGERENCIAS

Perfil GEMI
Ref. PFA2751
Pág. 439



Filtro de Proteção
12-48Vdc 5A 8A Cor Simples
Filtro de Protección Color Simple
Ref. 2238279.8192



COB CORDÉLIA 18W IP20



18W/m | IP20 | LED COB | 546 LED/m | 5m | CONEXÃO MÁXIMA 5m | DIMÁVEL | CRI 90 | 180° | M M | CE

Modelo	Ref.	Cor Color	Tensão Tensión	IP	Lumens /mt	Lumens /w
COB CORDÉLIA L70B50 33000H 5 Steps MacAdam	1324521.1827	2700K	24V	IP20	1260Lm	70Lm
	1324521.1830	3000K	24V	IP20	1296Lm	72Lm
	1324521.1840	4000K	24V	IP20	1530Lm	85Lm
	1324521.1860	6500K	24V	IP20	1530Lm	85Lm

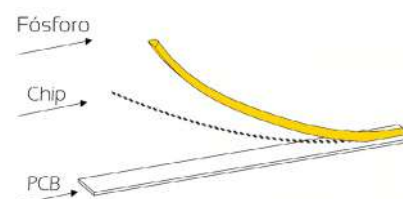
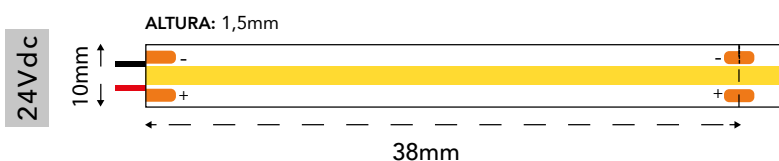
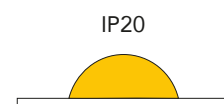

DESTAQUE | DESTACADO

Led Cob com muita potência | Led Cob con mucha potencia

SUGESTÕES | SUGERENCIAS

Aplicação de difusores mais transparentes nos perfis
Aplicación de difusores más transparentes en los perfiles



Dif. Lente 15°



Dif. Transparente

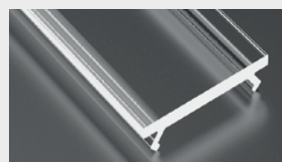

Dif. Semi-Opalino

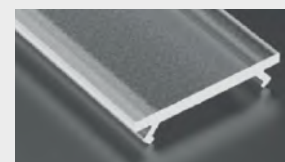

CALIPSO 18W IP20 | IP65

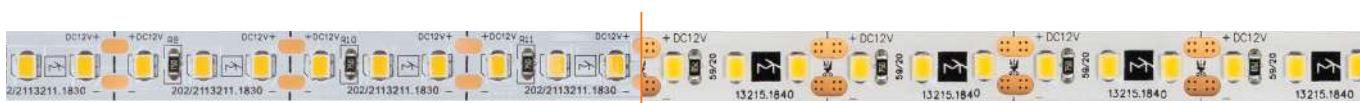

IP20 IP65

18W m IP20 IP65 20Z 2835 SMD 120 LED/m 5m CONEXÃO MÁXIMA 5m DIMÁVEL CRI 80 120° M M CE

Modelo	Ref.	Efic.	Cor Color	Tensão Tensión	IP	Lumens /mt	Lumens /w
CALIPSO L70B50 36000H 3 Steps MacAdam	13211.1830		3000K	12V	IP20	1764Lm	98Lm
	13211.1840		4000K	12V	IP20	1836Lm	102Lm
	13211.1860		6000K	12V	IP20	1836Lm	102Lm
CALIPSO 65 L70B10 50000H	13215.1830	G	3000K	12V	IP65	1390Lm	77Lm
	13215.1840	G	4000K	12V	IP65	1520Lm	84Lm
	13215.1860	G	6000K	12V	IP65	1650Lm	92Lm

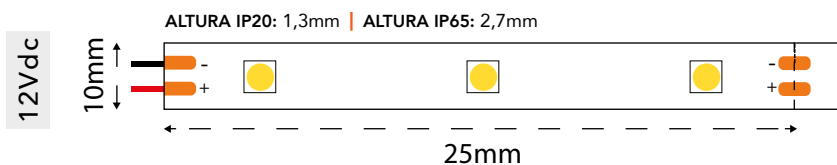
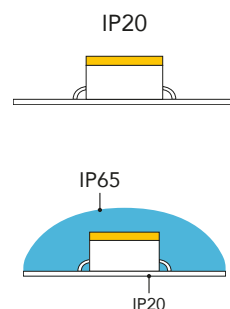

SUGESTÕES | SUGERENCIAS

Perfil alto para melhor dissipação de calor:
Alto perfil para una mejor disipación del calor:
Perfil Tipo Y
Ref. PFA131
Pág. 415



Filtro de Proteção
12-48Vdc 5A 8A Cor Simples
Filtro de Protección Color Simple
Ref. 2238279.8192



BELINDA 18W - 4 EM 1 IP20



Modelo	Ref.	Cor Color	Tensão Tensión	IP	Numens
BELINDA	13061.18RGBW	RGB + 6000k	24V	IP20	R: 625Nm G: 532Nm B: 475Nm + 902Lm/mt 6000K

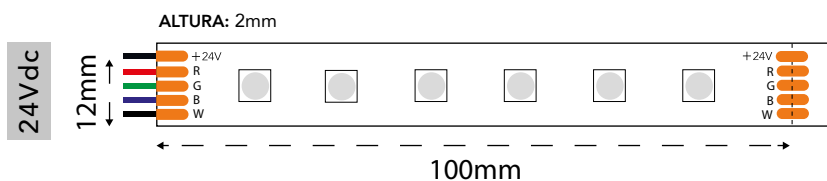
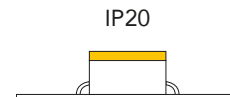

DESTAQUE | DESTACADO

Led RGB + 6000K

SUGESTÕES | SUGERENCIAS

LED 4 em 1:
LED 4 em 1:



Controlador RGB+W c/ comando RF
Controlador RGB+W c/ Mando RF
Ref. 212217.4480W
Pág. 334

_Vendido em kit (comando + controlador).
_Controla RGB + brancos.

_Vendido como kit (Mando + controlador);
_Controles RGB + brancos.



Filtro de Proteção
Filtro de Protección
12-48Vdc 5A RGBW
Ref. 2238278.8120



FERDINAND 18W IP20 | IP65



Modelo	Ref.	Cor Color	Tensão Tensión	IP	Lumens/ Numens
FERDINAND	13061.18RGBWW	RGB + 3000k	24V	IP20	R: 625Nm G: 532Nm B: 475Nm + 3000K: 420Lm/mt
FERDINAND 65	13065.18RGBWW	RGB + 3000k	24V	IP65	R: 620Nm G: 520Nm B: 465Nm + 3000K: 420Lm/mt

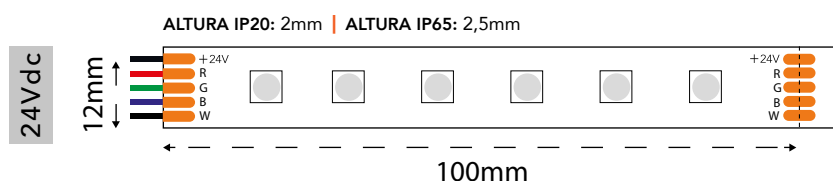
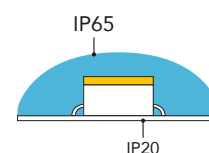
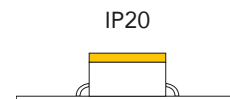

LED 4 em 1:
LED 4 en 1:



SUGESTÕES | SUGERENCIAS

Controlador RGB+W
Dali DT8*
Ref. 2126218.5480
Pág. 357



Filtro de Proteção
Filtro de Protección
12-48Vdc 5A RGBW
Ref. 2238278.8120



*Sistema de Auto Detection de canal DALI; Ecrã endereçável de DALI através de 2 switch.

*Sistema de detección automática de canales DALI; Display direccionable desde DALI a través de 2 interruptores.

STEPHANO 19W IP20



19,2W/m
IP20
30Z
3535 SMD
112 LED/m
SUPER RGB
5m
CONEXÃO MÁXIMA 5m
DIMÁVEL
120°
M M
CE

Modelo	Ref.	Cor Color	Tensão Tensão	IP	Numens
STEPHANO	1317321.19RGB	RGB	24V	IP20	R: 625Nm G: 532Nm B: 475Nm

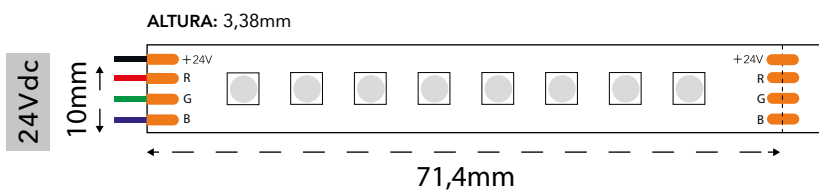
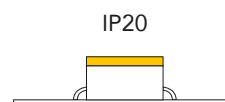

SUGESTÕES | SUGERENCIAS

Controlador RGB DMX512
Ref. 215422.4960
Pág. 388



Controlador RGB+W Control DMXPRO
Ref. 214722.440CH
Pág. 388

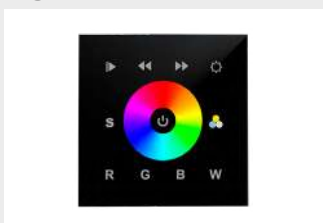

Filtro de Proteção
Filtro de Protecção
12-48Vdc 5A RGBW
Ref. 2238278.8120



PSÁMATA 19,2W IP67



19,2W/m | IP67 | 20Z | 2835 SMD | 160 LED/m | 5m | CONEXÃO MÁXIMA 5m | DIMÁVEL | CRI 80 | 120° | M M | CE

Modelo	Ref.	Efic.	Cor Color	Tensão Tensión	IP	Lumens /mt	Lumens /w
PSÁMATA 67	1311526.1927	F	2700K	24V	IP67	2100Lm	109Lm
L70B50 36000H	1311526.1930*	F	3000K	24V	IP67	2100Lm	109Lm
3 Steps MacAdam	1311526.1940	E	4000K	24V	IP67	2300Lm	120Lm
	1311526.1960	E	6000K	24V	IP67	2300Lm	120Lm



*NOTA:
 Alternativa à referência 131526.1930 após descontinuação.
 Alternativa a la referencia 131526.1930 después de la discontinuación.

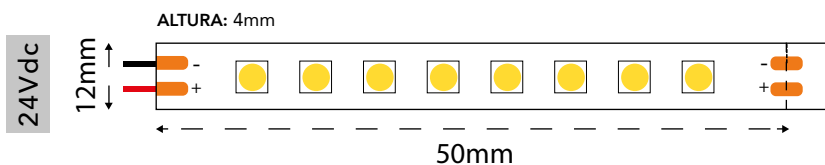

SUGESTÕES | SUGERENCIAS

Perfil largo para melhor dissipação de calor:
 Perfil ancho para una mejor disipación del calor:

Perfil Mogos | Ref. PFA8657
 Pág. 466



Filtro de Proteção
 12-48Vdc 5A 8A Cor Simples
 Filtro de Protección Color Simple
 Ref. 2238279.8192



CCT LEDA2F 19,2 W IP20

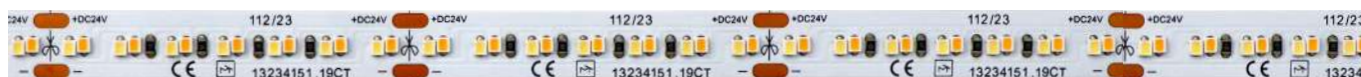

Modelo	Ref.	Efic.	Cor Color	Tensão Tensión	IP	Lumens /mt	Lumens /w
CCT LEDA2F L70B50 36000H	13234151.19CT		2700K 4000K 6500K	24V	IP20	810Lm	42Lm

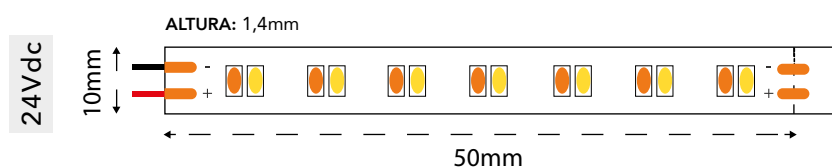
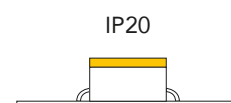

Ideal para instalações já existentes e pré-cabeadas. Ligação por apenas 2 fios.

Ideal para instalaciones existentes y precabeadas. Conexión con sólo 2 cables.

SUGESTÕES | SUGERENCIAS

Controlador CCT
PUSH/Dim RF
1x120W
Ref. 2111271.4120
Pág. 336



Comando CCT RF
1 Zona
Ref. 2120271.1CT
Pág. 336



CCT LEDA 19,3 W IP20 | IP67



IP20 | IP67

19,3W/m, IP20, IP67, 30Z, 240 LED/m, 5m, CONEXÃO MÁXIMA 5m, DIMÁVEL, CRI 80, 120°, M M, CE

Modelo	Ref.	Efic.	Cor Color	Tensão Tensión	IP	Lumens /mt	Lumens /w
CCT LEDA L70B50 36000H	139151.19CT	G	3000K 4000K 6000K	24V	IP20	1570Lm	81Lm
CCT LEDA67	1391156.19CT	F	2700K 4000K 6000K	24V	IP67	1200Lm	62Lm

2216 SMD

2835 SMD

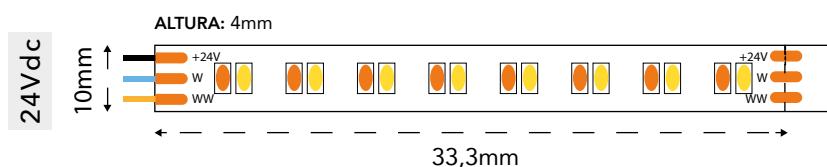
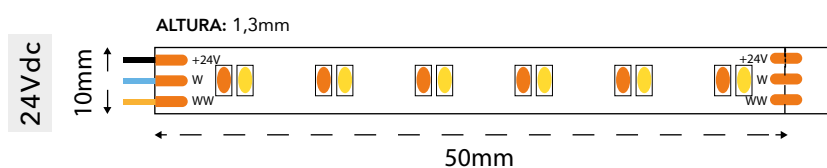

SUGESTÕES | SUGERENCIAS

Controlador de temperatura de cor c/ comando
Controlador de temperatura de color con mando
Ref. 2111226.5360
Pág. 336



Esta fita permite fazer uma regulação de temperatura de cor, variável de 3000K a 6000K. Faça o seu próprio cenário com ambientes independentes, com o novo sistema Casambi.

Esta tira te permite ajustar la temperatura de Color, variable de 3000K a 6000K. Crea tu propio escenario con entornos independientes, con el nuevo sistema Casambi.

CASAMBI

COB CCT LISITEIA 20W IP20



20W/m
IP20
LED COB
640 LED/m
5m
CONEXÃO MÁXIMA 5m
DIMÁVEL
CRI 90
180°
M M
CE

Modelo	Ref.	Cor Color	Tensão Tensión	IP	Lumens /mt	Lumens /w
COB CCT LISITEIA L70B50 54000H	1322521.20CT	2700K 6500K	24V	IP20	1760Lm	88Lm

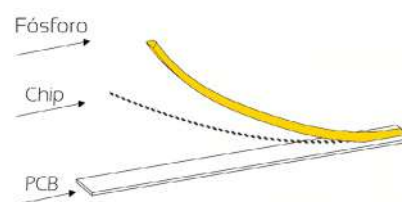
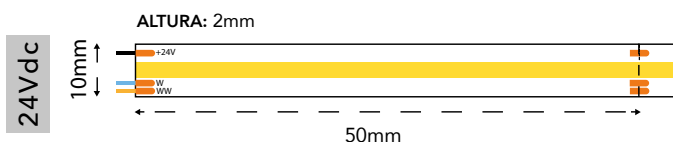
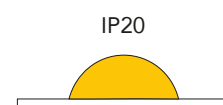

DESTAQUE | DESTACADO

_Fita com regulação de temperatura de cor
_Tira con regulación de temperatura de color

SUGESTÕES | SUGERENCIAS

Controlador dimmer RF+Wifi+Push Nexta Ref. 2127258.4240 Pág. 369



Comando 1 Zona de regulação de temperatura de cor Mando 1 Zona regulación de temperatura de color Ref. 2127259.1CCT Pág. 374



CSP CCT LISITEIA 20W IP20

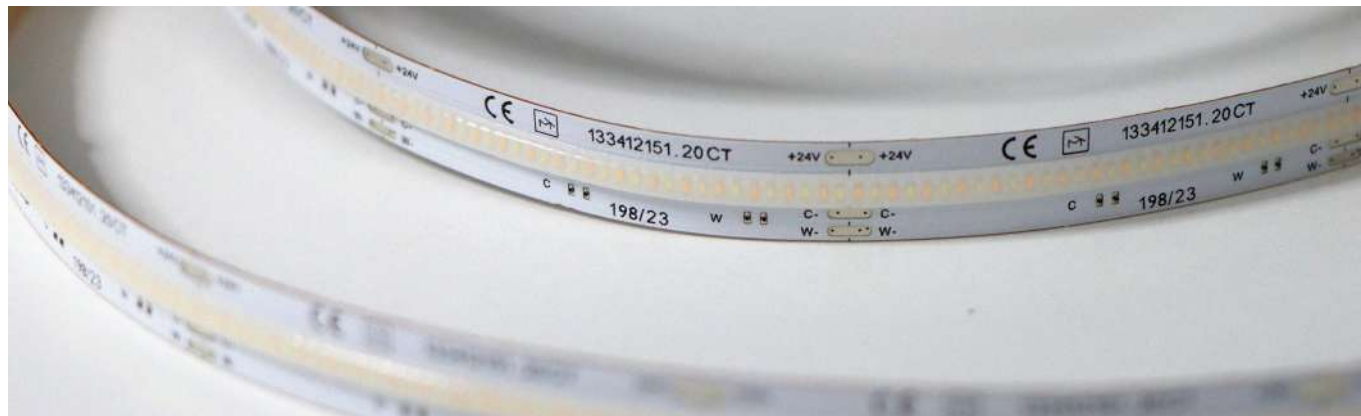

20W/m
IP20
CSP LED
640 LED/m
5m
CONEXÃO MÁXIMA 5m
DIMÁVEL
CRI 90
180°
M M
CE

Modelo	Ref.	Efic.	Cor Color	Tensão Tensión	IP	Lumens /mt	Lumens /w
CSP CCT LISITEIA L70B50 36000H	133412151.20CT	G	2700K 4000K 6500K	24V	IP20	1760Lm	88Lm

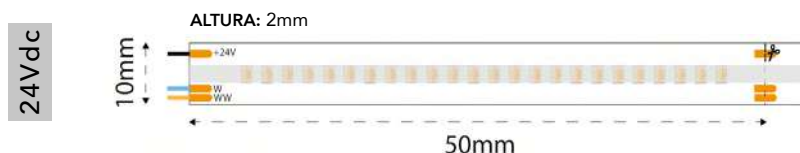
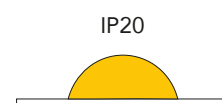

DESTAQUE | DESTACADO

_Fita com regulação de temperatura de cor
_Tira con regulación de temperatura de color

SUGESTÕES | SUGERENCIAS

Controlador dimmer RF + Wifi + Push Nexta
 Ref. 2127258.4240
 Pág. 369



Comando 1 Zona de regulação de temperatura de cor |
 Mando 1 Zona regulación de temperatura de color
 Ref. 2127259.1CCT
 Pág. 374



Perfil Alcanede
 Ref. PFA8811
 Pág. 457

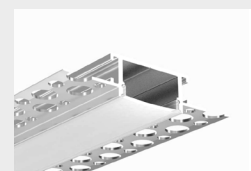

PRAXIDIQUE 20W IP20



EF+
20W/m
IP20
20Z
2835 SMD
160 LED/m
2940 Lm/m
147 Lm/W
5m
CONEXÃO MÁXIMA 5m
CRI 90
M M
CE

Modelo	Ref.	Efic.	Cor Color	Tensão Tensión	IP	Lumens /mt	Lumens /w
PRAXIDIQUE L70B50 50000H 3 Steps MacAdam	1311621.2027	E	2700K	24V	IP20	2630Lm	132Lm
	1311621.2030	E	3000K	24V	IP20	2900Lm	145Lm
	1311621.2040	D	4000K	24V	IP20	2980Lm	147Lm
	1311621.2060	D	6000K	24V	IP20	2980Lm	147Lm
PRAXIDIQUE 50M	13116341.2030	E	3000K	24V	IP20	2900Lm	145Lm
	13116341.2040	D	4000K	24V	IP20	2940Lm	147Lm

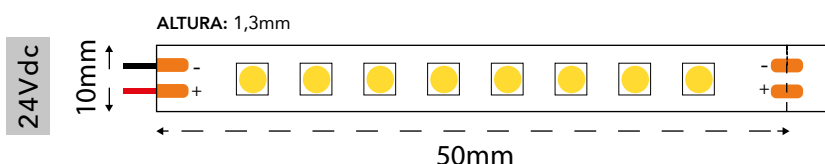
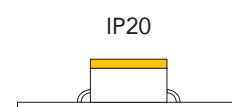

SUGESTÕES | SUGERENCIAS

Perfil Apa 12
Ref. PFA841
Pág. 471



Filtro de Proteção
12-48Vdc 5A 8A Cor Simple
Filtro de Protección Color Simple
Ref. 2238279.8192



OFÉLIA 24W - 5 EM 1 IP20



Modelo	Ref.	Cor Color	Tensão Tensión	IP	Numens/Lumens
OFÉLIA	13081.28RGBWA	RGB + 2400k + 6000K	24V	IP20	R: 625Nm G: 532Nm B: 475Nm + 540Lm/mt - 2400K 720Lm/mt - 6000K

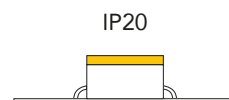

Ideal para cenários televisivos e ambientes noturnos onde se pretende cor e temperatura neutra.

Ideal para platós de televisión y ambientes nocturnos donde se requiera color y temperatura neutra.

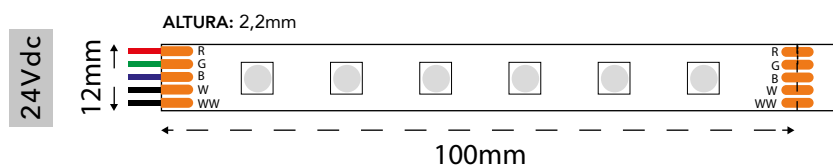

SUGESTÕES | SUGERENCIAS

CONTROLO POR ZIGBEE
CONTROL POR ZIGBEE:
Controlador RGB+W+WW
Ref. 2122246.4480
Pág. 381
+
Comando Touch RGBW+WW
Ref. 2122246.RGB+W+WW
Pág. 384



Filtro de Proteção
Filtro de Protección
12-48Vdc 5A RGBW
Ref. 2238278.8120



TIONE 26W IP20



EF+
26W/m
IP20
20Z
3040 LED
160 LED/m
3740 Lm/m
144 Lm/W
5m
CONEXÃO MÁXIMA 5m
DIMÁVEL
CRI 80
M M
CE

Modelo	Ref.	Efic.	Cor Color	Tensão Tensión	IP	Lumens /mt	Lumens /w
TIONE	1311621.2627	E	2700K	24V	IP20	3380Lm	130Lm
L80B10 50000H	1311621.2630	E	3000K	24V	IP20	3510Lm	135Lm
3 Steps MacAdam	1311621.2640	E	4000K	24V	IP20	3510Lm	135Lm
	1311621.2660	E	6000K	24V	IP20	3620Lm	139Lm

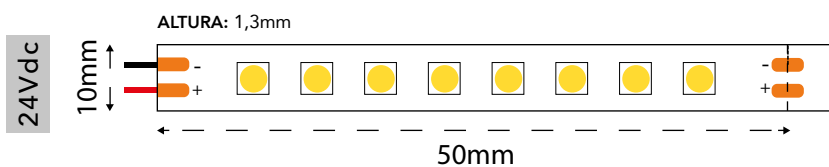
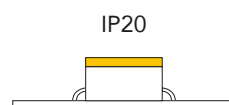

SUGESTÕES | SUGERENCIAS

Perfil largo para melhor dissipação de calor:
 Perfil ancho para una mejor disipación del calor:
 Perfil Penegache
 Ref. PFA2461
 Pág. 424

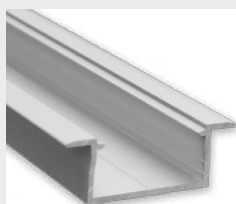

Filtro de Proteção
 12-48Vdc 5A 8A Cor Simples
 Filtro de Protección Color Simple
 Ref. 2238279.8192



CARONTE 34W IP20



EF+
34W/m
IP20
20Z
3040 LED
192 LED/m
4690 Lm/m
138 Lm/W
5m
CONEXÃO MÁXIMA 5m
DIMÁVEL
CRI >80
M M
CE

Modelo	Ref.	Efic.	Cor Color	Tensão Tensión	IP	Lumens /mt	Lumens /w
CARONTE	1323621.3427	E	2700K	24V	IP20	4200Lm	124Lm
L80B10 36000H	1323621.3430	E	3000K	24V	IP20	4380Lm	129Lm
3 Steps MacAdam	1323621.3440	E	4000K	24V	IP20	4690Lm	138Lm
	1323621.3460	E	6000K	24V	IP20	4470Lm	131Lm

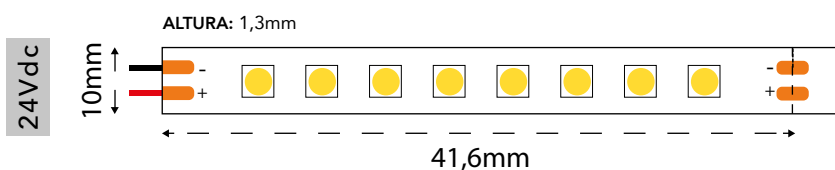
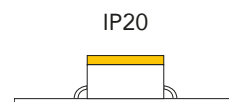

SUGESTÕES | SUGERENCIAS

Perfil alto para melhor dissipação de calor:
 Alto perfil para una mejor disipación del calor:
 Perfil Dublin
 Ref. PFA121
 Pág. 421



Filtro de Proteção
 12-48Vdc 5A 8A Cor Simples
 Filtro de Protección Color Simple
 Ref. 2238279.8192



PANDORA 40W IP20

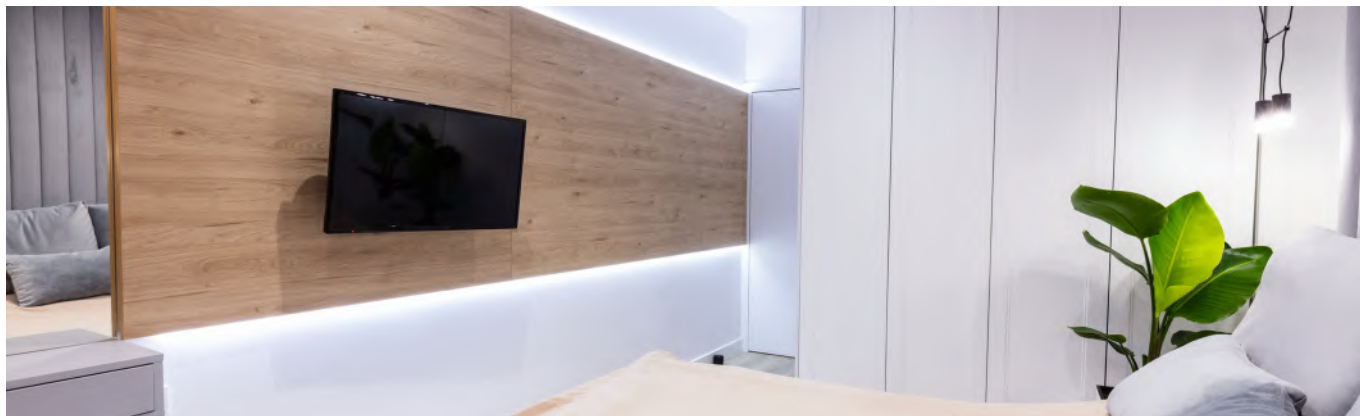

EF+	40W/m	IP20	20Z	3040 LED	256 LED/m	5640 Lm/m	141 Lm/W	5m	CONEXÃO MÁXIMA 5m	DIMÁVEL	CRI 80	M M	CE
-----	-------	------	-----	----------	-----------	-----------	----------	----	-------------------	---------	--------	-----	----

Modelo	Ref.	Efic.	Cor Color	Tensão Tensión	IP	Lumens /mt	Lumens /w
PANDORA L80B10 36000H 3 Steps MacAdam	1319621.4027*	E	2700K	24V	IP20	5040Lm	126Lm
	1319621.4030*	E	3000K	24V	IP20	5240Lm	131Lm
	1319621.4040*	E	4000K	24V	IP20	5640Lm	141Lm
	1319621.4060*	E	6000K	24V	IP20	5400Lm	135Lm

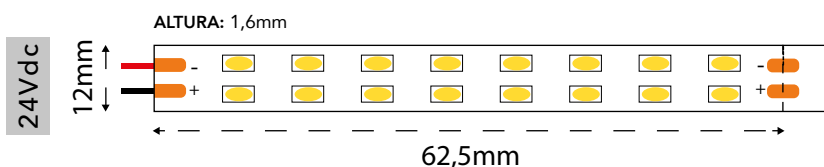
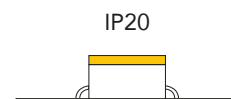

* NOTA:
Alternativas às referências 13921.42XX após descontinuação.
Alternativas a las referencias 13921.42XX después de la discontinuación.

SUGESTÕES | SUGERENCIAS

Perfil largo para melhor dissipação de calor:
Perfil ancho para una mejor disipación del calor:
Perfil Safarujó
Ref. PFA8667
Pág. 466



Filtro de Proteção
12-48Vdc 5A 8A Cor Simples
Filtro de Protección Color Simple
Ref. 2238279.8192







FITAS LED RGB

Tiras Led RGB

FRANCISCO 7W IP20 | IP68



* ESTA FITA LED NÃO INCLUI FITA ADESIVA
Esta tira de led no incluye cinta adhesiva.



Modelo	Ref.	Cor Color	Tensão Tensión	IP	Numens
FRANCISCO	130151.07RGB	RGB	24V	IP20	R: 625Nm G: 532Nm B: 475Nm
FRANCISCO 68	130157.07RGB	RGB	24V	IP68	R: 625Nm G: 532Nm B: 475Nm

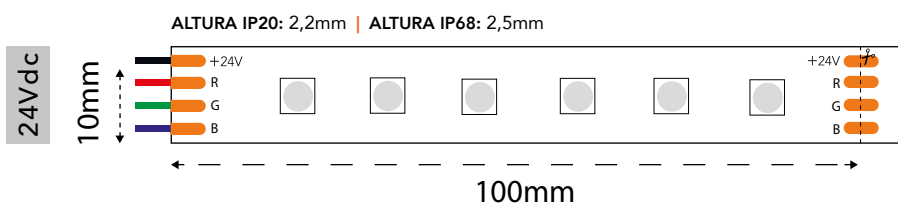
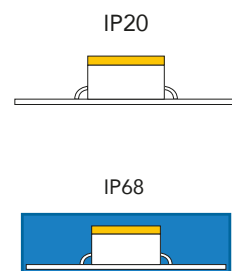

SUGESTÕES | SUGERENCIAS

Controlador RGB c/ Comando
Controlador RGB c/ Mando
Ref. 212217.1180
Pág. 334

Filtro de Proteção
Filtro de Protección
12-48Vdc 5A RGBW
Ref. 2238278.8120

_O mesmo comando poderá controlar até 100 controladores através de programação.
_El mismo mando puede controlar hasta 100 controladores a través de la programación.

JULIETA 7,2W IP20 | IP65



IP20 | IP65

7,2W/m | IP20 | IP65 | 20Z | 5050 SMD | 30 LED/m | RGB | 5m | CONEXÃO MÁXIMA 5m | DIMÁVEL | CRI 80 | 120° | M M | CE

Modelo	Ref.	Cor Color	Tensão Tensión	IP	Numens
JULIETA	13141.07RGB	RGB	24V	IP20	R: 625Nm G: 532Nm B: 475Nm
JULIETA 65	13145.07RGB	RGB	24V	IP65	

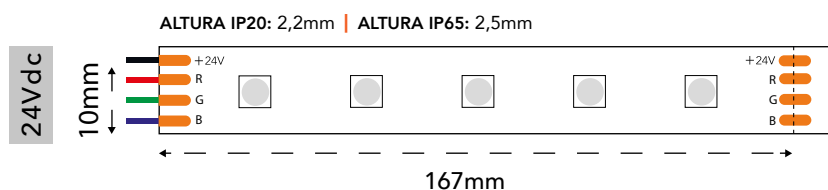
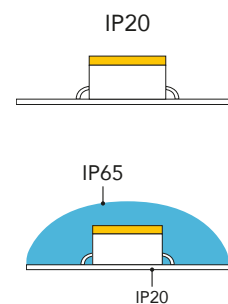

SUGESTÕES | SUGERENCIAS

CONTROLO POR CASAMBI:
CONTROL POR CASAMBI:
Controlador Dimmer 4x5A Push
Dalcnet
Ref. 2113224.4240
Pág. 341



Filtro de Proteção
12-48Vdc 5A 8A Cor Simples
Filtro de Protección Color Simple
Ref. 2238279.8192



_Controlador CASAMBI com 4 entradas e 4 saídas.
_Ideal para controlar RGB, RGB+W, RGBW, 4xDim, controle temperatura de cor.

_Controlador CASAMBI de 4 entradas y 4 salidas.
_Ideal para controlar RGB, RGB+W, RGBW, 4xDim, control de temperatura de color.

MIRANDA 14,4W IP20



8 mm	14,4W m	IP20	30Z	3535 SMD	120 LED/m	RGB	5m	CONEXÃO MÁXIMA 5m	DIMÁVEL	120°	M M	CE
------	---------	------	-----	----------	-----------	-----	----	-------------------	---------	------	-----	----

Modelo	Ref.	Cor Color	Tensão Tensión	IP	Numens
MIRANDA	1323191.14RGB	RGB	24V	IP20	R: 625Nm G: 532Nm B: 475Nm

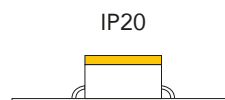
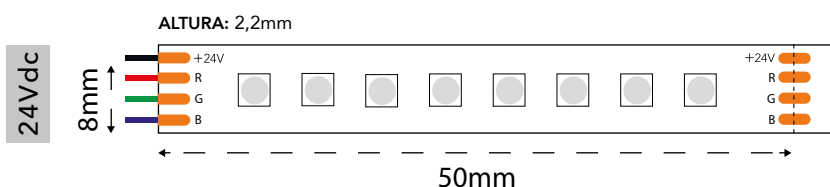

SUGESTÕES | SUGESTÕES

Perfil Tipo X | Ref. PFA1111
Pág. 377

Perfil Tipo A

Perfil Tipo X



Filtro de Proteção 12-48Vdc 5A RGBW
Filtro de Protección 12-48Vdc 5A RGBW
Ref. 2238278.8120



Devido à largura de 8 mm a fita é ideal para aplicações mais reduzidas e para aplicar em perfis de menores dimensões, como por exemplo o perfil Xangai.

Debido a su ancho de 8 mm, la tira es ideal para aplicaciones más pequeñas y para aplicar en perfiles más pequeños, como el perfil Xangai.

MARGARET 14,4W IP20 | IP65 | IP68



* ESTA FITA LED NÃO INCLUI FITA ADESIVA
Esta tira de led no incluye cinta adhesiva.



IP20 | IP65 | IP68

14,4W/m | IP20 | IP65 | IP68 | 20Z | 5050 SMD | 60 LED/m | RGB | 5m | CONEXÃO MÁXIMA 5m | DIMÁVEL | CRI 80 | 120° | M M



Modelo	Ref.	Cor Color	Tensão Tensión	IP	Numens
MARGARET L70B50 36000H	9W 13041.09VM	Vermelho Rojo	24V	IP20	625Nm
	12W 13041.12AZ	Azul	24V	IP20	475Nm
	14,4W 13011.14VD	Verde	12V	IP20	532Nm
MARGARET	13011.14RGB	RGB	12V	IP20	
	13041.14RGB	RGB	24V	IP20	
MARGARET 65	13015.14RGB	RGB	12V	IP65	
	13045.14RGB	RGB	24V	IP65	
MARGARET 68	13017.14RGB	RGB	12V	IP68	

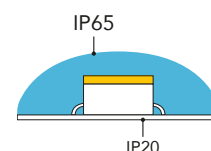
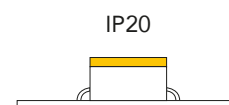

R: 625Nm
G: 532Nm
B: 475Nm

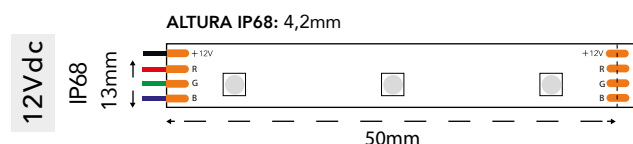

HELENE 14,4W IP20 | IP68



* ESTA FITA LED NÃO INCLUI FITA ADESIVA
Esta tira de led no incluye cinta adhesiva.



14,4W/m | IP20 | IP68 | 20Z | 5050 SMD | 60 LED/m | RGB | 10m | CONEXÃO MÁXIMA 20m | DIMÁVEL | CRI 80 | 120° | M M | CE

Modelo	Ref.	Cor Color	Tensão Tensión	IP	Numens
HELENE	13051.14RGB	RGB	24V	IP20	R: 625Nm G: 532Nm B: 475Nm
HELENE 68	13057.14RGB	RGB	24V	IP68	

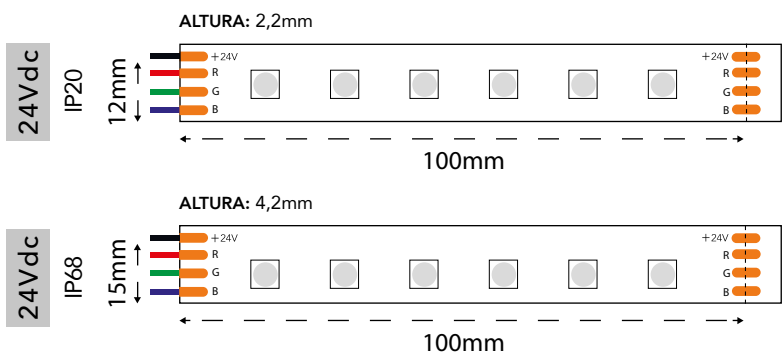
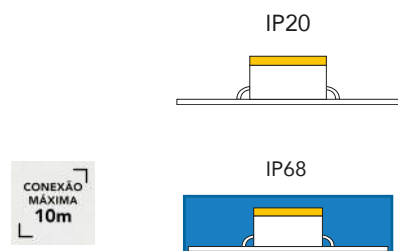

SUGESTÕES | SUGERENCIAS

CONTROLO POR WIFI: | CONTROL WIFI:

Controlador RGB+W
Ref. 211243.4480
Pág. 333

Antena Wifi/RF
Ref. 218244

Comando RF 1 Zona
Controlo RGB+W
Ref. 2120244.RGBW
Pág. 334

Filtro de Proteção
Filtro de Protección
12-48Vdc 5A RGBW
Ref. 2238278.8120



DIONE 14,4W IP20 | IP67



Modelo	Ref.	Cor Color	Tensão Tensão	IP	Lumens/Numens
DIONE	1315321.14RGB+27	RGB + 2700K	24V	IP20	R: 105Nm G: 330Nm B: 67Nm 2700K: 270Lm/mt
	1315321.14RGB+40	RGB + 4000K	24V	IP20	R: 105Nm G: 330Nm B: 67Nm 4000K: 320Lm/mt
DIONE 67	1315326.14RGB+30	RGB + 3000K	24V	IP67	RGB + 3000K: 700Nm
	1315326.14RGB+40	RGB + 4000K	24V	IP67	RGB + 4000K: 750Nm

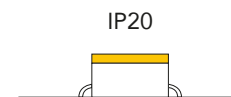

ALTURA IP20: 1,8mm | ALTURA IP67: 5mm

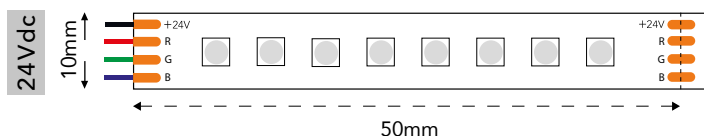

SUGESTÕES | SUGERENCIAS

IP20			IP67	
Perfil Andorra ANODIZADO Ref. PFA111 Pág. 413	Amplificador RGB+W Ref. 216217.4480 Pág. 395	Controlador DIM/CCT/RGBW/RGB+CCT Ref. 2131224.4384 Pág. 362	Topo S/Furo OBÉRON Ref. 22255	Perfil Gemi ANODIZADO Ref. PFA2751 Pág. 439

COB E CSP CALIQUE 15W | 18W IP20



Modelo	Ref.	Cor Color	Tensão	IP	Numens
COB CALIQUE	1329541.15RGB	RGB	24V	IP20	R: 127Nm G: 580Nm B: 70Nm
CSP CALIQUE	13291241.15RGB*	RGB	24V	IP20	R: 782Nm G: 150Nm B: 575Nm
COB CALIQUE	1329541.18RGBW	RGB + 6000K	24V	IP20	R: 120Nm G: 531Nm B: 86Nm 6000K: 489Nm

15W/m

15W/m

18W/m

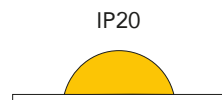

*NOTA: Alternativa à referência 1329541.15RGB após descontinuação.
Alternativa a la referencia 1329541.15RGB después de la discontinuación.

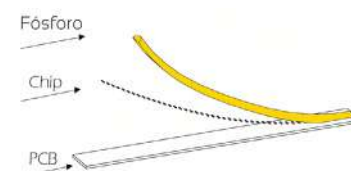
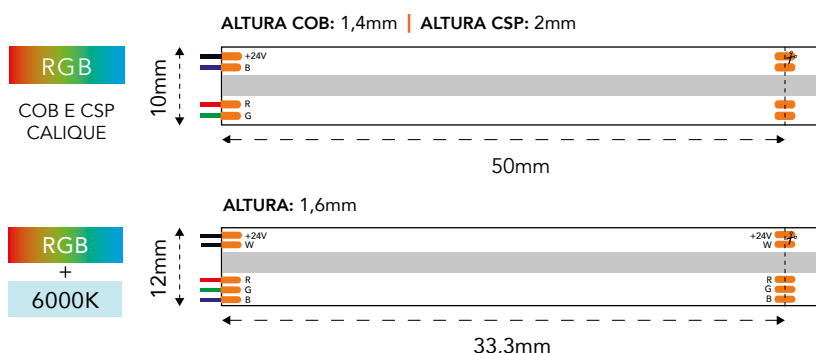

SUGESTÕES | SUGERENCIAS

Controlador RGB com Comando | con Mando
Ref. 212217.1180
Pág. 334

O comando pode controlar até 100 controladores por programação. | El mando puede controlar hasta 100 controladores por programación.



Filtro de Proteção
Filtro de Protección
12-48Vdc 5A RGBW
Ref. 2238278.8120



BELINDA 18W - 4 EM 1 IP20



Modelo	Ref.	Cor Color	Tensão Tensión	IP	Numens
BELINDA	13061.18RGBW	RGB + 6000k	24V	IP20	R: 625Nm G: 532Nm B: 475Nm + 902Lm/mt 6000K

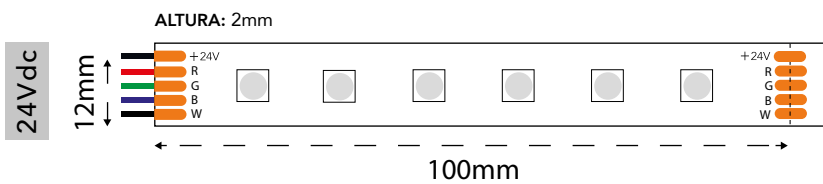
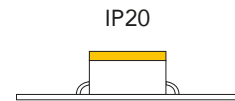

LED 4 em 1:
LED 4 em 1:



RGB
+
6000K

DESTAQUE | DESTACADO

Led RGB + 6000K

SUGESTÕES | SUGERENCIAS

Controlador RGB+W c/ comando RF
Controlador RGB+W c/ Mando RF
Ref. 212217.4480W
Pág. 334

_Vendido em kit (comando + controlador).
_Controla RGB + brancos.

_Vendido como kit (Mando + controlador);
_Controles RGB + brancos.



Filtro de Proteção
Filtro de Protección
12-48Vdc 5A RGBW
Ref. 2238278.8120



FERDINAND 18W IP20 | IP65



Modelo	Ref.	Cor Color	Tensão Tensión	IP	Lumens/ Numens
FERDINAND	13061.18RGBWW	RGB + 3000k	24V	IP20	R: 625Nm G: 532Nm B: 475Nm + 3000K: 420Lm/mt
FERDINAND	65 13065.18RGBWW	RGB + 3000k	24V	IP65	R: 620Nm G: 520Nm B: 465Nm + 3000K: 420Lm/mt

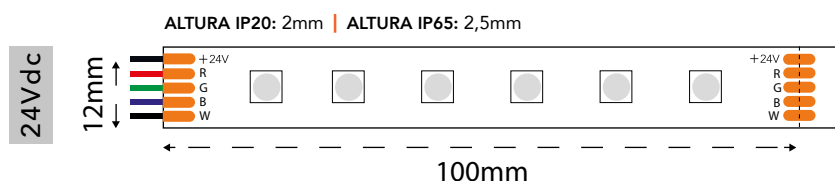
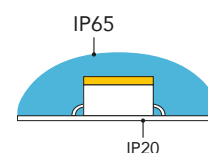
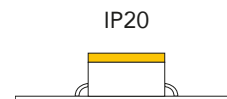

LED 4 em 1:
LED 4 en 1:



SUGESTÕES | SUGERENCIAS

Controlador RGB+W
Dali DT8*
Ref. 2126218.5480
Pág. 357



Filtro de Proteção
Filtro de Protección
12-48Vdc 5A RGBW
Ref. 2238278.8120



*Sistema de Auto Detection de canal DALI; Ecrã endereçável de DALI através de 2 switch.

*Sistema de detección automática de canales DALI; Display direccional desde DALI a través de 2 interruptores.

STEPHANO 19W IP20



19,2W/m
IP20
30Z
3535 SMD
112 LED/m
SUPER RGB
5m
CONEXÃO MÁXIMA 5m
DIMÁVEL
120°
M M
CE

Modelo	Ref.	Cor Color	Tensão Tensão	IP	Numens
STEPHANO	1317321.19RGB	RGB	24V	IP20	R: 625Nm G: 532Nm B: 475Nm

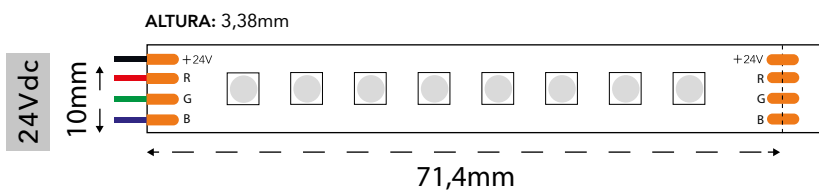
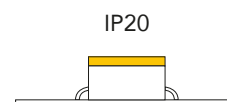

SUGESTÕES | SUGERENCIAS

Controlador RGB DMX512
Ref. 215422.4960
Pág. 388



Controlador RGB+W Control DMXPRO
Ref. 214722.440CH
Pág. 388

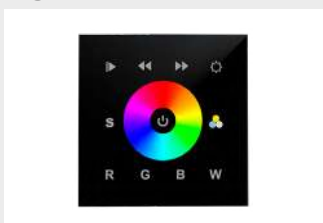

Filtro de Proteção
Filtro de Protecção
12-48Vdc 5A RGBW
Ref. 2238278.8120



OFÉLIA 24W - 5 EM 1 IP20



Modelo	Ref.	Cor Color	Tensão Tensión	IP	Numens/ Lumens
OFÉLIA	13081.28RGBWA	<div style="display: flex; flex-direction: column; align-items: center;"> <div style="background-color: #ff0000; width: 20px; height: 10px; margin-bottom: 2px;"></div> RGB <div style="background-color: #00ff00; width: 20px; height: 10px; margin-bottom: 2px;"></div> + <div style="background-color: #0000ff; width: 20px; height: 10px; margin-bottom: 2px;"></div> 2400k <div style="background-color: #000000; width: 20px; height: 10px; margin-bottom: 2px;"></div> + <div style="background-color: #ffffff; width: 20px; height: 10px; margin-bottom: 2px;"></div> 6000K </div>	24V	IP20	R: 625Nm G: 532Nm B: 475Nm + 540Lm/mt - 2400K 720Lm/mt - 6000K

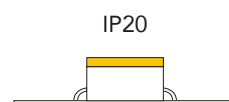

Ideal para cenários televisivos e ambientes noturnos onde se pretende cor e temperatura neutra.

Ideal para platós de televisión y ambientes nocturnos donde se requiera color y temperatura neutra.

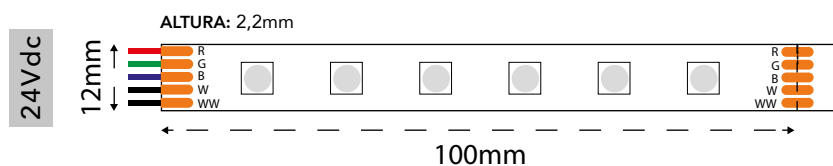

SUGESTÕES | SUGERENCIAS

CONTROLO POR ZIGBEE
 CONTROL POR ZIGBEE:
 Controlador RGB+W+WW
 Ref. 2122246.4480
 Pág. 381
 +
 Comando Touch RGBW+WW
 Ref. 2122246.RGB+W+WW
 Pág. 384



Filtro de Proteção
 Filtro de Protección
 12-48Vdc 5A RGBW
 Ref. 2238278.8120





REGULAÇÃO DE TEMPERATURA

Regulación de temperatura

CCT LEDA2F 19,2 W IP20

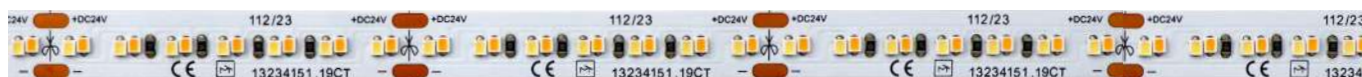

Modelo	Ref.	Efic.	Cor Color	Tensão Tensión	IP	Lumens /mt	Lumens /w
CCT LEDA2F L70B50 36000H	13234151.19CT		2700K 4000K 6500K	24V	IP20	810Lm	42Lm

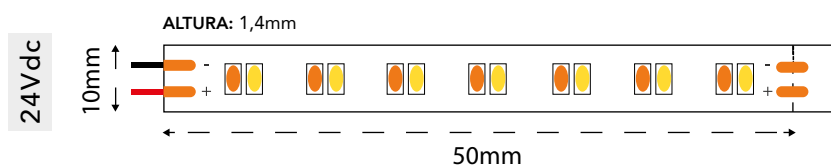
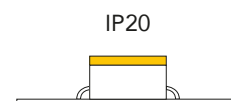

Ideal para instalações já existentes e pré-cabeadas. Ligaçãõ por apenas 2 fios.

Ideal para instalaciones existentes y precabeadas. Conexión con sólo 2 cables.

SUGESTÕES | SUGERENCIAS

Controlador CCT
PUSH/Dim RF
1x120W
Ref. 2111271.4120
Pág. 336



Comando CCT RF
1 Zona
Ref. 2120271.1CT
Pág. 336



CCT LEDA 19,3 W IP20 | IP67



IP20 | IP67

19,3W/m, IP20, IP67, 30Z, 240 LED/m, 5m, CONEXÃO MÁXIMA 5m, DIMÁVEL, CRI 80, 120°, M M, CE

Modelo	Ref.	Efic.	Cor Color	Tensão Tensión	IP	Lumens /mt	Lumens /w
CCT LEDA L70B50 36000H	139151.19CT	G	3000K 4000K 6000K	24V	IP20	1570Lm	81Lm
CCT LEDA67	1391156.19CT	F	2700K 4000K 6000K	24V	IP67	1200Lm	62Lm

2216 SMD

2835 SMD

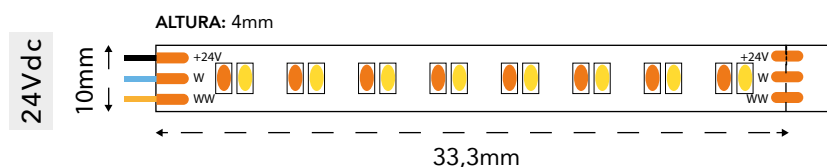
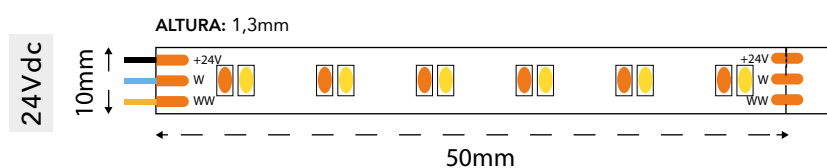

SUGESTÕES | SUGERENCIAS

Controlador de temperatura de cor c/ comando
Controlador de temperatura de color con mando
Ref. 2111226.5360
Pág. 336



Esta fita permite fazer uma regulação de temperatura de cor, variável de 3000K a 6000K. Faça o seu próprio cenário com ambientes independentes, com o novo sistema Casambi.

Esta tira te permite ajustar la temperatura de Color, variable de 3000K a 6000K. Crea tu propio escenario con entornos independientes, con el nuevo sistema Casambi.

CASAMBI

COB CCT LISITEIA 20W IP20



Modelo	Ref.	Cor Color	Tensão Tensión	IP	Lumens /mt	Lumens /w
COB CCT LISITEIA L70B50 54000H	1322521.20CT	2700K 6500K	24V	IP20	1760Lm	88Lm

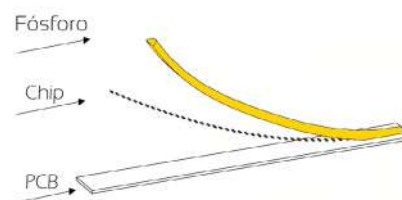
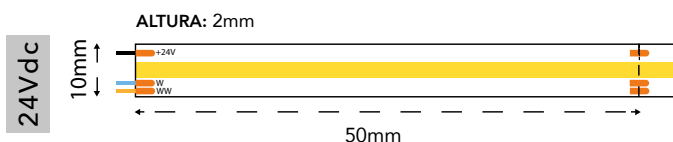
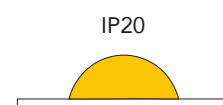

DESTAQUE | DESTACADO

_Fita com regulação de temperatura de cor
_Tira con regulación de temperatura de color

SUGESTÕES | SUGERENCIAS

Controlador dimmer
RF+Wifi+Push Nexta
Ref. 2127258.4240
Pág. 369



Comando 1 Zona de regulação
de temperatura de cor
Mando 1 Zona regulación
de temperatura de color
Ref. 2127259.1CCT
Pág. 374



CSP CCT LISITEIA 20W IP20

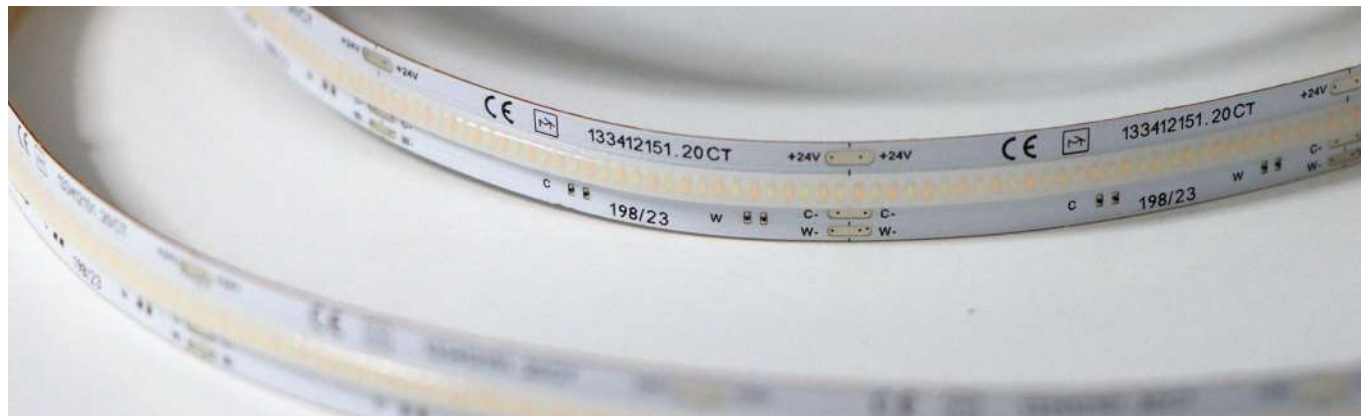

Modelo	Ref.	Efic.	Cor Color	Tensão Tensión	IP	Lumens /mt	Lumens /w
CSP CCT LISITEIA L70B50 36000H	133412151.20CT		2700K 4000K 6500K	24V	IP20	1760Lm	88Lm

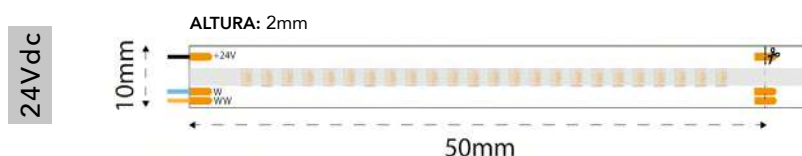
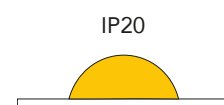

DESTAQUE | DESTACADO

_Fita com regulação de temperatura de cor
_Tira con regulación de temperatura de color

SUGESTÕES | SUGERENCIAS

Controlador dimmer RF + Wifi + Push Nexta
 Ref. 2127258.4240
 Pág. 369



Comando 1 Zona de regulação de temperatura de cor |
 Mando 1 Zona regulación de temperatura de color
 Ref. 2127259.1CCT
 Pág. 374



Perfil Alcanede
 Ref. PFA8811
 Pág. 457

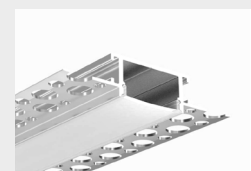

MEGACLITE DIM-TO-WARM 10W IP20

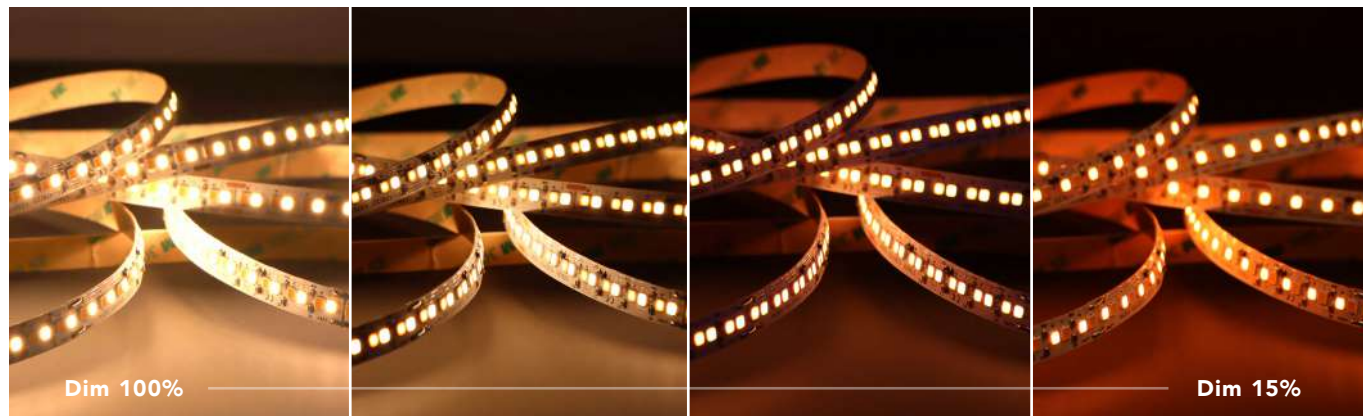

10W/m	IP20	2835 SMD	2228 LED/m	5m	CONEXÃO MÁXIMA 5m	DIMÁVEL	20Z	CRI 90	120°	M M	CE
-------	------	----------	------------	----	-------------------	---------	-----	--------	------	-----	----

Modelo	Ref.	Efic.	Cor Color	Tensão Tensión	IP	Lumens /mt	Lumens /w
MEGACLITE L70B50 50000H	13351151.10DW	F	1800K a 3000K	24V	IP20	1010Lm	10Lm

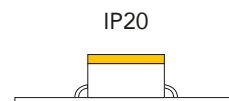

Ideal para criar ambientes acolhedores. Permite reduzir/aumentar a intensidade luminosa. Ao reduzir a fita também diminui em simultâneo a cor de luz dos 3000K aos 1800K e vice versa.

Ideal para crear ambientes acogedores. Le permite reducir/aumentar la intensidad de la luz. Al reducir la cinta también reduce simultáneamente el color de la luz de 3000K a 1800K y viceversa.

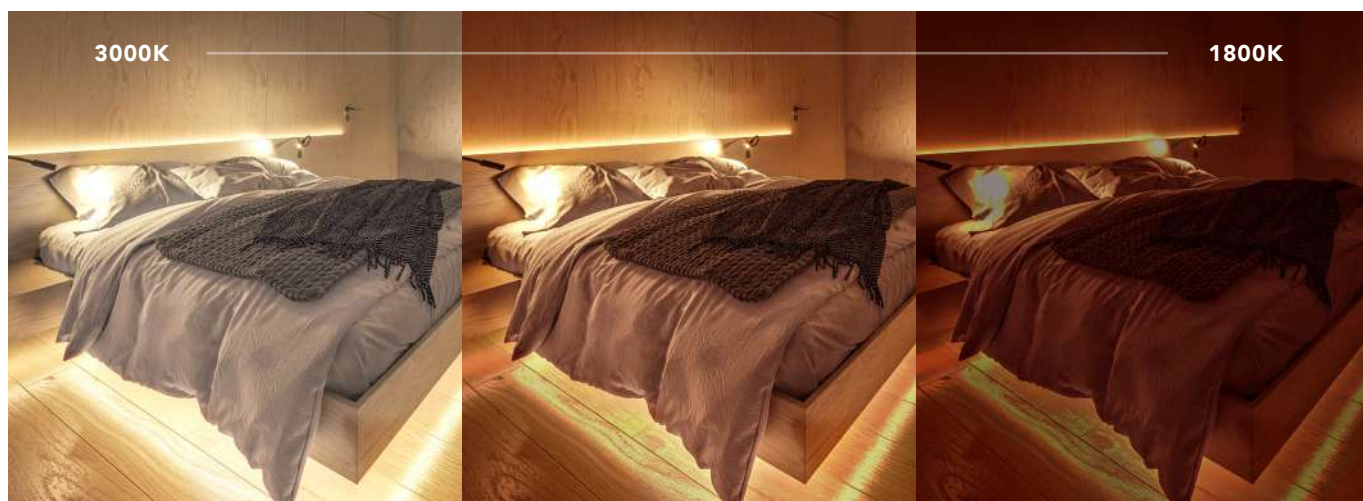

FULL SPECTRUM 2000K-10000K IP20



24V DC
12W/m
IP20
CRI ≥90
2216 LED
336 LED/m
DIMÁVEL
M M
CE
NOVO NUEVO

Modelo	Ref.	Cor Color	Tensão Tensión	IP	Lumens /mt	Lumens /w
FULL SPECTRUM L80B10 50000H	13414481.12	2000K 10000K	24V	IP20	2220Lm	148Lm

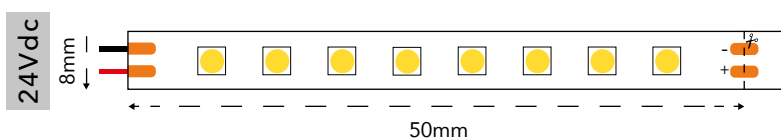
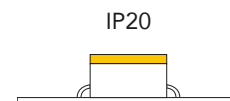

SUGESTÕES | SUGERENCIAS

Perfil Led Gemi
ANODIZADO
Ref. PFA2751
Pág. 439

Difusor Semi-Opalino
SEMI-OPALINO
Ref. DF3SOE
Pág. 402

Fonte Alimentação
24V 120W IP20
Ref. 201561.2120
Pág. 267

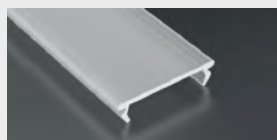

DÊ TOTAL LIBERDADE À SUA IMAGINAÇÃO E CRIE CENÁRIOS PERSONALIZADOS

DALE TOTAL LIBERTAD A TU IMAGINACIÓN
Y CREA ESCENARIOS PERSONALIZADOS



Acesso remoto
através de uma cloud
Acceso remoto a
través de una cloud

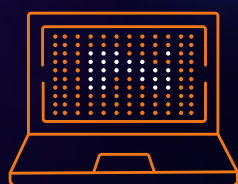

Design e criação
de cenários
Diseño y creación
de escenarios

Implementação dos
cenários criados
Implementación de los
escenarios creados



Controlo
de Cenários
Control
de Escenarios



Fitas digitais
Tiras digitales

**Para soluções específicas
e à sua medida deverá ser
adquirida uma licença de
funcionamento**

**Para soluciones específicas
y a medida, se debe adquirir
una licencia de funcionamiento**



FITAS LED DIGITAL

Tiras Led digital

DIGITAL MAGIC 14,4W IP20



14,4W/m IP20 30Z 5050 SMD 60 LED/m MAGIC RGB 5m CONEXÃO MÁXIMA 5m DIMÁVEL 120° M M CE

Modelo	Ref.	Cor Color	Tensão Tensión	IP	Numens
DIGITAL MAGIC	13011.14MAGIC	RGB	12V	IP20	R: 625Nm G: 532Nm B: 475Nm

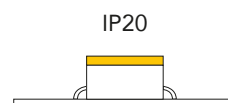

IC - WS2811 20 Pixel/mt

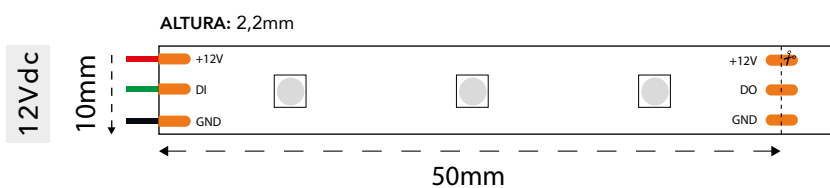

SUGESTÕES | SUGERENCIAS

Esta fita requer controlador. Consulte-nos para a melhor solução.

Esta tira requiere controlador. Consúltenos para la mejor solución.

O QUE É O IC?

O IC é um Integrate Circuit que está inserido dentro de um diodo, que permite ordenar as suas funções. Ajuste de temperatura de cor, intensidade e alternância de cor. Normalmente usado e controlado através de um BUS interno do circuito eletrônico (PCB, fita de led). Este controlo é feito a partir de um controlador.

O IC é projetado com uma linha de dados, duas linhas de energia, 256 tons de cinza, alto brilho, uma rápida transferência de dados, atualização rápida de tela, etc. Com o controlador, pode obter monocromático, gradiente, texto, números, fotos, animações, vídeo, qualquer efeito, e assim por diante.

¿QUÉ ES IC?

El IC es un Circuito Integrado que se inserta dentro de un diodo, lo que permite ordenar sus funciones. Ajuste de temperatura de color, intensidad de color y alternar. Suele utilizarse y controlarse a través de un BUS de circuito electrónico interno (PCB, tira de LED). Este control se realiza desde un controlador.

El IC está diseñado con una línea de datos, dos líneas de alimentación, escala de grises 256, alto brillo, transferencia de datos rápida, actualización de pantalla rápida, etc. Con el controlador, puede obtener monocromo, degradado, texto, números, fotos, animaciones, video, cualquier efecto, etc.

DIGITAL RGB 18W IP20



Modelo	Ref.	Cor Color	Tensão Tensión	IP	Numens/Lumens
DIGITAL RGB	1307171.18DIG	RGB	5V	IP20	R: 625Nm G: 532Nm B: 475Nm

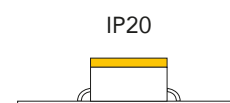

IC - WS2812B 60 Pixel/mt

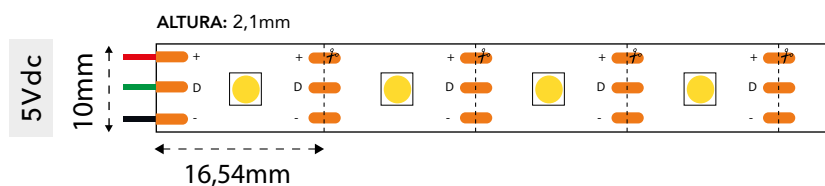

SUGESTÕES | SUGERENCIAS

Esta fita requer controlador. Consulte-nos para a melhor solução.

Esta tira requiere controlador. Consúltenos para la mejor solución.

APLICAÇÕES DA FITA | APLICACIONES DE TIRAS

- | | |
|------------------------|-----------------------|
| _Ambientes noturnos | _Ambientes nocturnos |
| _Iluminação pública | _Alumbrado público |
| _Shoppings | _Centros comerciais |
| _Hotéis | _Hoteles |
| _Paisagens decorativas | _Paisajes decorativos |
| _Discotecas | _Discotecas |

COB DIGITAL RGB 18W IP20



18W/m
IP20
720 LED/m
5 VDC
LED COB
5m
CONEXÃO MÁXIMA 5m
DIMÁVEL
180°
M M
CE

Modelo	Ref.	Cor Color	Tensão Tensión	IP	Numens/ Lumens
COB DIGITAL RGB	13315331.18DIG	RGB	5V	IP20	R: 620-630Nm G: 520-530Nm B: 460-470Nm

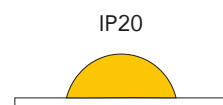

IC - WS2811 80 Pixel/mt

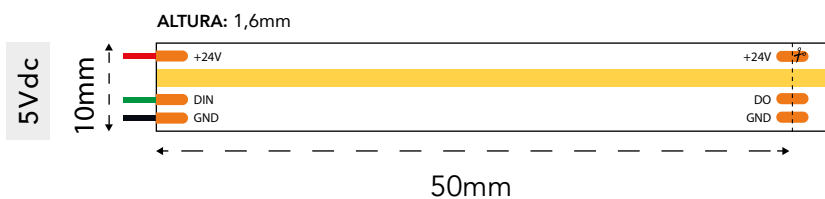

SUGESTÕES | SUGERENCIAS

Esta fita requer controlador.
 Consulte-nos para a melhor solução.

Esta tira requiere controlador.
 Consúltenos para la mejor solución.

COB DIGITAL 3000K 12W IP20

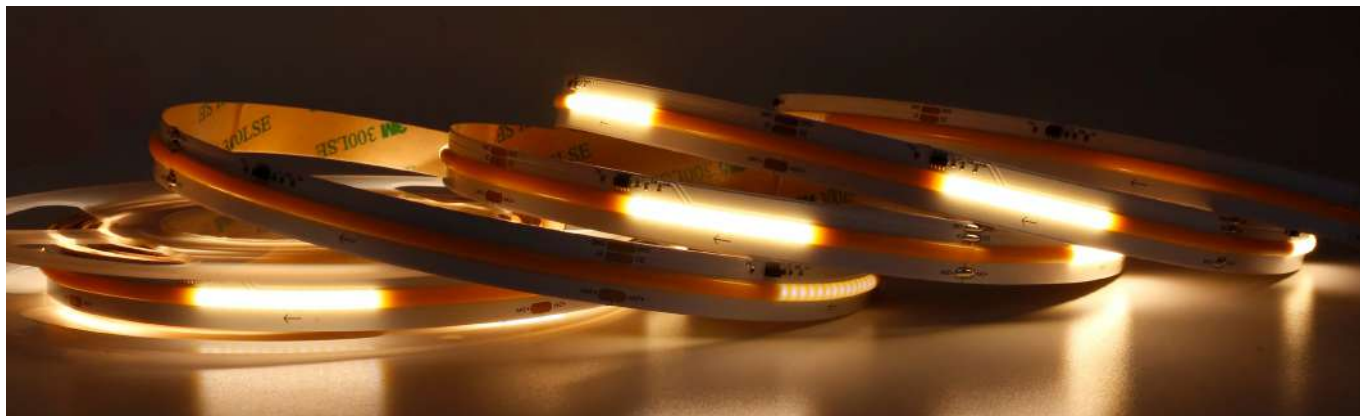

12W/m
IP20
20Z
360 LED/m
24V DC
LED COB
5m
CONEXÃO MÁXIMA 5m
DIMÁVEL
180°
M M
CE

Modelo	Ref.	Efic.	Cor Color	Tensão Tensão	IP	Lumens
COB DIGITAL 3000K	13305331.12DIGWW	F	3000K	24V	IP20	1210Lm

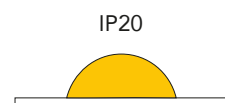

IC - WS2811 12 Pixel/mt

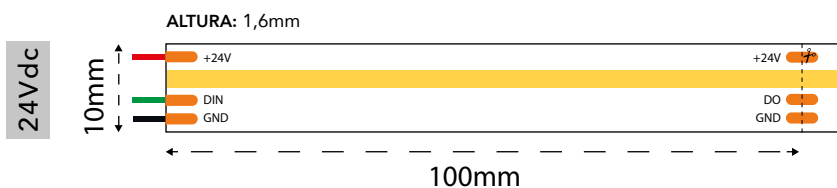

SUGESTÕES | SUGERENCIAS

Esta fita requer controlador. Consulte-nos para a melhor solução.

Esta tira requiere controlador. Consúltenos para la mejor solución.

DIGITAL 18W IP20



18W/m IP20 5050 SMD 60 LED/m 5 VDC 20Z 5m CONEXÃO MÁXIMA 5m DIMÁVEL CRI 80 120° M M CE

Modelo	Ref.	Efic.	Cor Color	Tensão Tensão	IP	Lumens
DIGITAL	1307171.18DIGWW	F	3000K	5V	IP20	1760Lm/mt
L70B50 33000H 5 Steps MacAdam	1307171.18DIGNW		4000K	5V	IP20	1890Lm

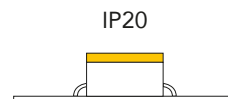

IC - WS2812B 60 Pixel/mt

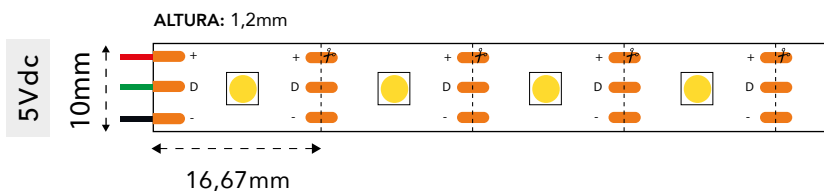

SUGESTÕES | SUGERENCIAS

Esta fita requer controlador.
Consulte-nos para a melhor solução.

Esta tira requiere controlador.
Consúltenos para la mejor solución.

LED NEON DIGITAL TALASSA 12W IP44

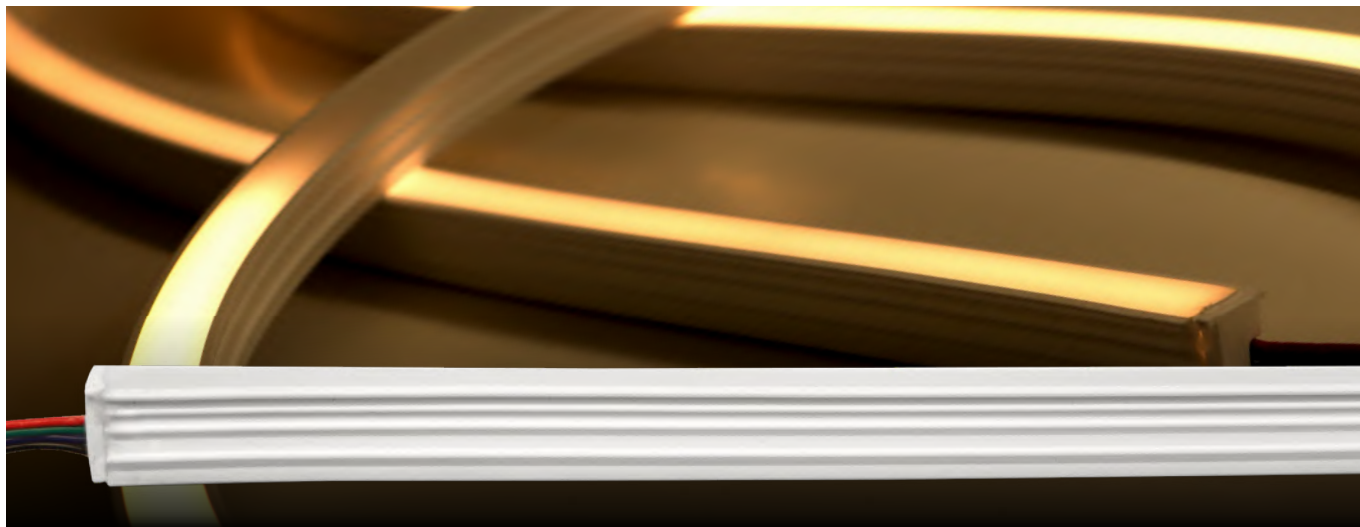

Modelo	Ref.	Cor Color	Tensão Tensión	IP	Lumens
NEON DIGITAL TALASSA	1336123.12DIGWW	3000K	24V	IP44	290Lm

IC - WS2818 8 Pixel/mt

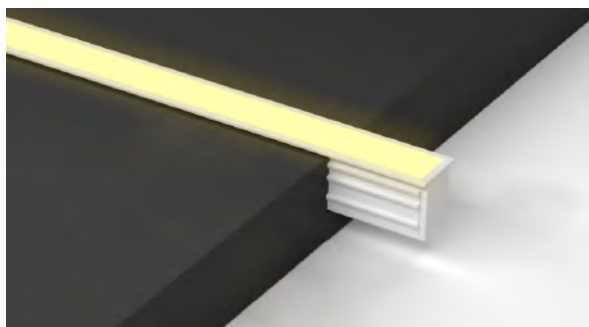
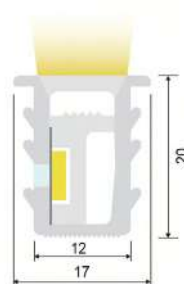
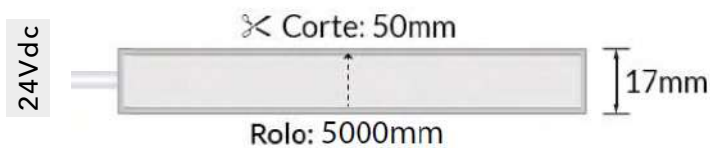
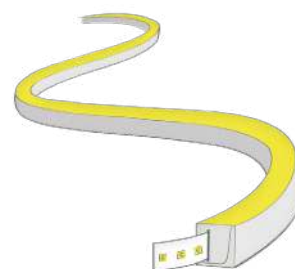

SUGESTÕES | SUGERENCIAS

Este neon requer controlador. Consulte-nos para a melhor solução.

Este néon requiere controlador. Consúltenos para la mejor solución.



FONTES IP20 FUENTES IP20



Modelo	Ref.	Input	Tensão Tensión	Potência Potencia
LRS	201161.4150	85-264V	5Vdc	110W

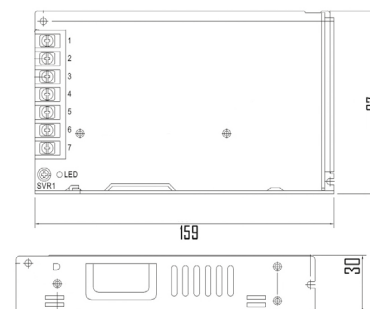

Modelo	Ref.	Input	Tensão Tensión	Potência Potencia
UHP	201371.4200	90-264V	5Vdc	200W
	201371.4350	90-264V	5Vdc	300W

200W

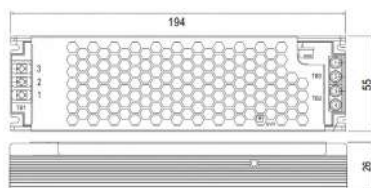

300W

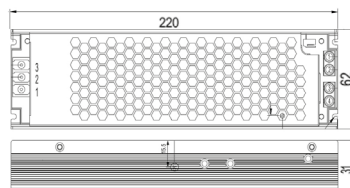

FONTES IP67 FUENTES IP67



Modelo	Ref.	Input	Tensão Tensión	Potência Potencia
LPV	201176.460	90-264V	5Vdc	40W
	201176.4100	90-264V	5Vdc	60W

40W

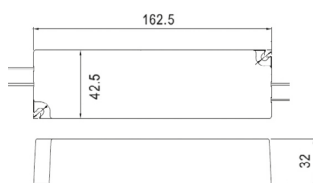

60W

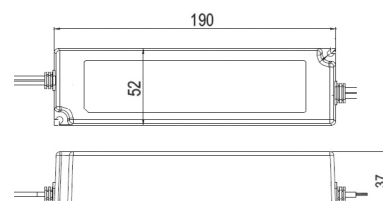

CONTROLOADOR DIGITAL DMX / RF



REF. 2122124.104

_2 universos. Compatível com 45 tipos de chip. Controlo remoto sem fio. Controlo de pixel: 900 Pixel.

_2 universos. Compatible with 45 tipos de chips. Control remoto inalámbrico. Control de píxeles: 900 píxeles.

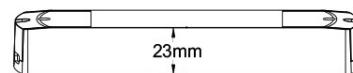

CONTROLOADOR DIGITAL PUSH



REF. 2122127.105

Controlador PUSH

- _ Funciona por PUSH permitindo que seja dada a ordem para arranque do ciclo e, depois de voltar a clicar, faz o ciclo inverso
- _ Função sem fios, 2.4G RF
- _ Para fitas digitais RGB e cor simples
- _ Permite o controlo em cascata, para que seja possível um arranque retardado do 2º controlador
- _ Ideal para zonas de passagem como corredores e escadas.
- _ Diversos cenários, com várias velocidades e brilhos da luz.



REF. 2122126.105

Controlador PUSH
c/ Sensor de movimento

- _ Funciona mediante PUSH permitindo que se dé la orden de inicio del ciclo y, tras volver a pulsar, realiza el ciclo inverso
- _ Función sin hilos, 2.4G RF
- _ Para cintas digitales RGB y de un solo color
- _ Permite el control en cascada, por lo que es posible un inicio retardado del 2.º controlador
- _ Ideal para zonas de paso como pasillos y escaleras.
- _ Varios escenarios, con varias velocidades y brillos de luz.

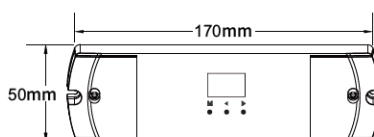

CONTROLOADOR DIGITAL WIFI + TUYA

REF. 21221251.103



_2 universos. Compatível com 45 tipos de IC. Modo de cenário dinâmico e personalizado. Múltiplos ritmos musicais. Controlo remoto sem fio. Controlo de pixel: 1000 Pixel.

_2 universos. Compatible with 45 tipos de IC. Modo escenario dinámico y personalizado. Múltiples ritmos musicales. Control remoto inalámbrico. Control de píxeles: 1000 píxeles.

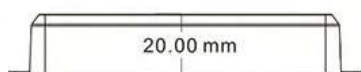
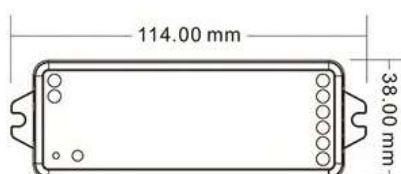

COMANDO RF

REF. 2120253.1DIG

Comando RF
1 Zona ECO
controlo p/
fitas digitais

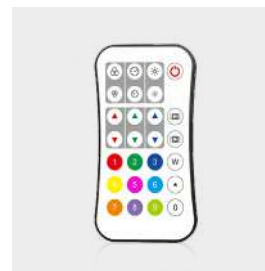

Mando RF 1
ECO control p/
tiras digitales





ILUMINAÇÃO ESPECIAL

Iluminación especial

PINK MEAT COB 10W IP20



10W IP20 20Z LED COB 5m CONEXÃO MÁXIMA 5m DIMÁVEL CRI 90 180° M M CE

Modelo	Ref.	Cor Color	Tensão Tensión	IP	Lumens /mt	Lumens /w
PINK MEAT COB 3 Steps MacAdam	231551.1014	PINK	24V	IP20	400Lm	40Lm

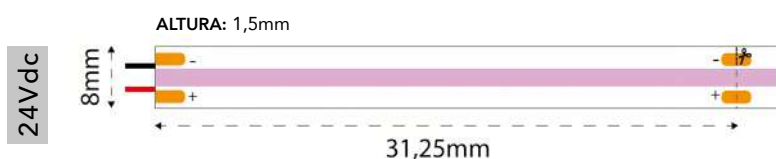
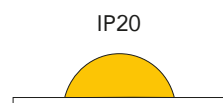

SUGESTÕES | SUGERENCIAS

Perfil Xangai
Ref. PFA1111
Pág. 411

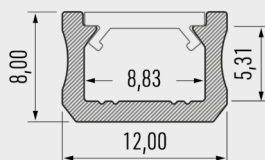

PINK MEAT 14,4W IP20



14,4W/m	IP20	20Z	5050 SMD	60 LED/m	5m	CONEXÃO MÁXIMA 5m	DIMÁVEL	CRI 80	120°	M M	CE
---------	------	-----	----------	----------	----	-------------------	---------	--------	------	-----	----

Modelo	Efic.	Ref.	Cor Color	Tensão Tensión	IP	Lumens /mt	Lumens /w
PINK MEAT		23151.1214	2000K 2200K	12V	IP20	1138Lm	79Lm

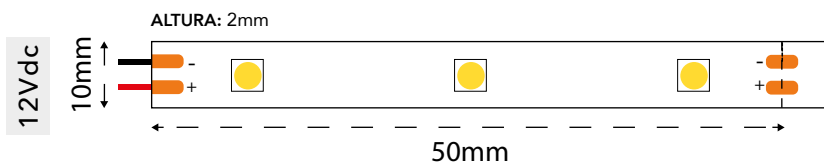

A iluminação de talhos e de qualquer tipo de estabelecimento onde se comercializam produtos frescos é fundamental para que os alimentos se apresentem nas melhores condições e com uma aparência cuidada e natural. A iluminação LED para talhos está ajustada para realçar as cores avermelhadas da carne de uma forma natural. Além disso não gera calor, garantindo uma melhor conservação dos produtos.

La iluminación de carnicerías y cualquier tipo de establecimiento donde se expandan productos frescos es fundamental para que los alimentos presentes en las mejores condiciones y con un aspecto cuidado y natural. La iluminación LED para carnicerías se ajusta para resaltar los colores rojizos de la carne de forma natural. Además, no genera calor, asegurando una mejor conservación de los productos.

SUGESTÕES | SUGERENCIAS

Perfil Tipo D
Ref. PFA1191
Pág. 412

LUMINES LIGHTING

DESTAQUE | DESTACADO

Fita para iluminação de montras de carne
Tira especial para iluminación de vitrinas cárnicas

PINK MEAT POWER 24W IP20



24W/m	20Z	IP20	2835 LED	120 LED/m	5m	CONEXÃO MÁXIMA 5m	DIMÁVEL	CRI 80	120°	M M	CE
-------	-----	------	----------	-----------	----	-------------------	---------	--------	------	-----	----

Modelo	Ref.	Cor Color	Tensão Tensión	IP	Lumens /mt	Lumens /w
PINK MEAT POWER	21151.224	2000K 2200K	24V	IP20	1996Lm	83Lm

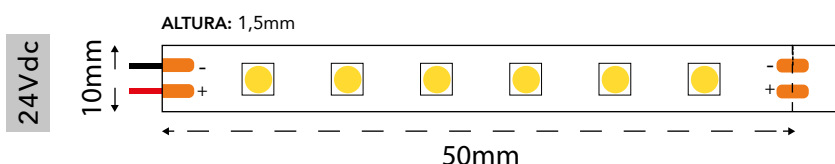
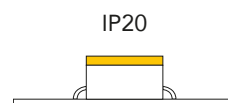

Uma luz inapropriada pode resultar numa aparência pouco atrativa que atribui à carne uma cor acastanhada, mesmo sendo aquela de melhor qualidade.

La luz inadecuada puede resultar en una apariencia poco atractiva que le da a la carne un color marrón, aunque sea de la mejor calidad.

SUGESTÕES | SUGERENCIAS

Perfil Andorra
Ref. PFA111
Pág. 413

DESTAQUE | DESTACADO

_Fita especial para iluminação de montras de carne
_Tira especial para iluminación de vitrinas cárnicas

UV LUZ NEGRA POWER 24W IP20



24W m	IP20	2835 LED	240 LED/m	5m	CONEXÃO MÁXIMA 5m	DIMÁVEL	120°	M M	CE
----------	------	-------------	--------------	----	-------------------------	---------	------	-----	----

Modelo	Ref.	Cor Color	Tensão Tensión	IP	Numens /mt
UV LUZ NEGRA POWER	139121.24UV	UV	24V	IP20	400-410Nm

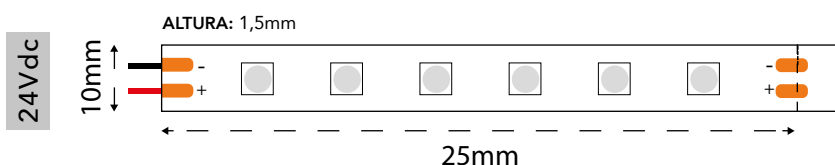
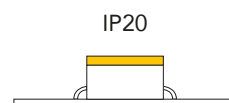

DESTAQUE | DESTACADO

- _Fita especial para iluminação de zonas de ambientes noturnos (discotecas, bares, etc.)
- _Tira especial para zonas de iluminación en ambientes nocturnos (discotecas, bares, etc.)

SUGESTÕES | SUGERENCIAS

Perfil Mangacha
Ref. PFA2471
Pág. 434

ACESSÓRIOS PARA FITA LED

ACESSORIOS PARA TIRA LED

NOVO
NUEVO

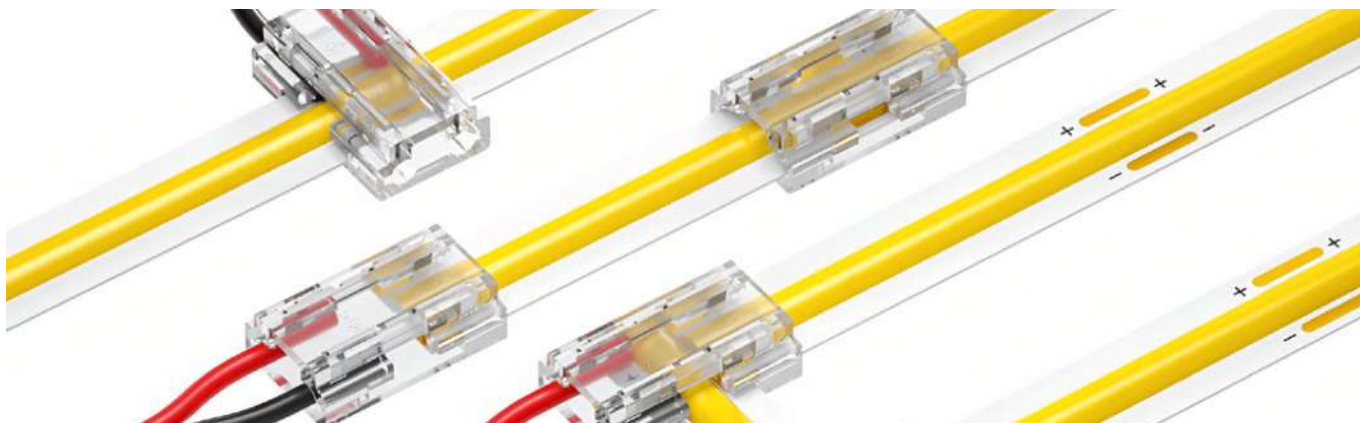

Ref. 2211511.19

Ligador de Cravar
IP20 2 linhas
Multifunção 8mm
Conector de
Clavija IP20 2 líneas
Multifunción 8mm



Ref. 221152.19

Ligador de Cravar
IP20 2 linhas
Multifunção 10mm
Conector de
Clavija IP20 2 líneas
Multifunción 10mm



Ref. 227111.19

União cravar FLAT
IP20 2 linhas 8mm
Unión clavada FLAT
IP20 2 líneas 8mm



Ref. 227211.19

Ligador cravar c/fio FLAT
IP20 2 linhas 8mm
Conector c/ cable FLAT
IP20 2 líneas 8mm



Ref. 227311.19

União c/ fio cravar FLAT
IP20 2 linhas 8mm
Unión c/ cable clavado
FLAT IP20 2 líneas 8mm



Ref. 227411.19

Curva 90° cravar FLAT
IP20 2linhas 8mm
Curva de 90° clavable
FLAT IP20 2 líneas 8mm



Ref. 227112.19

União cravar FLAT
IP20 2 linhas 10mm
Unión clavada FLAT
IP20 2 líneas 10mm



Ref. 227212.19

Ligador cravar c/ fio
FLAT IP20 2 linhas 10mm
Conector c/ cable FLAT
IP20 2 líneas 10mm



Ref. 227312.19

União c/ fio cravar FLAT
IP20 2 linhas 10mm
Unión c/ cable clavado
FLAT IP20 2 líneas 10mm



Ref. 227412.19

Curva 90° cravar FLAT IP20
2linhas 10mm
Curva de 90° c/ Fijación
FLAT IP20 2 líneas 10mm



Ref. 223640.33

Fita Cola Dupla
Face 3M VHB
Fita Cola Dupla
Face 3M VHB

10x0,60x33000mm

Ref. 223640.5

10x0,60x5000mm

Ref. 223640.1233

12x0,60x33000mm

Ref. 223640.125

12x0,60x5000mm



Ref. SPRAY PROTEÇÃO

Spray de proteção IP54
Aerosol de protección IP54

ACESSÓRIOS PARA FITA LED IP20

ACESSORIOS PARA TIRA LED IP20



Ref. 227122.18	Ref. 227742.78	Ref. 227342.78	Ref. 227782.18	Ref. 227322.18
União cravar FLAT IP20 4 linhas 10mm Unión clavada FLAT IP20 4 líneas 10mm	Ligador cravar c/ fio FLAT IP20 3 linhas 10mm Conector c/ cable FLAT IP20 3 líneas 10mm	União c/ fio cravar FLAT IP20 3 linhas 10mm Unión c/ cable clavado FLAT IP20 3 líneas 10mm	Ligador cravar c/ fio FLAT IP20 4 linhas 10mm Conector c/ cable FLAT IP20 4 líneas 10mm	União c/ fio cravar FLAT IP20 4 linhas 10mm Unión c/ cable clavado FLAT IP20 4 líneas 10mm
REF. 224218.1	Ref. 225219.1	Ref. 225218.1	Ref. 221211	Ref. 221212
União IP20 p/ 4 fios RGB * Para fitas de 10mm Unión IP20 p/ 4 hilos RGB * Para tiras 10mm	Ligador IP20 c/ 2 fios * Para fitas de 10mm Conector IP20 c/ 2 hilos * Para tiras 10mm	Ligador IP20 c/ 4 fios RGB * Para fitas de 10mm Conector IP20 c/ 4 hilos RGB * Para tiras 10mm	Ligador de cravar IP20 c/ 2 fios * Para fitas de 8mm Conector para crimpar IP20 c/ 2 hilos * Para tiras 8mm	Ligador de cravar IP20 c/ 2 fios * Para fitas de 10mm Conector para crimpar IP20 c/ 2 hilos * Para tiras 10mm
Ref. 221222	Ref. 221233	Ref. 221111	Ref. 221112	Ref. 221122
Ligador de cravar IP20 c/ 4 fios * Para fitas de 10mm Conector para crimpar IP20 c/ 4 hilos * Para tiras 10mm	Ligador de cravar IP20 c/ 5 fios * Para fitas de 12mm Conector para crimpar IP20 c/ 5 hilos * Para tiras 12mm	União de cravar IP20 c/ 2 pinos * Para fitas de 8mm Unión para crimpar IP20 c/ 2 pinos * Para tiras 8mm	União de cravar IP20 c/ 2 pinos * Para fitas de 10mm Unión para crimpar IP20 c/ 2 pinos * Para tiras 10mm	União de cravar IP20 c/ 4 pinos * Para fitas de 10mm Unión para crimpar IP20 c/ 4 pinos * Para tiras 10mm
Ref. 221133	Ref. 221311	Ref. 221312	Ref. 221322	Ref. 221333
União de cravar IP20 c/ 5 pinos * Para fitas de 12mm Unión para crimpar IP20 c/ 5 pinos * Para tiras 12mm	União de cravar IP20 c/ 2 fios * Para fitas de 8mm Unión para crimpar IP20 c/ 2 hilos * Para tiras 8mm	União de cravar IP20 c/ 2 fios * Para fitas de 10mm Unión para crimpar IP20 c/ 2 hilos * Para tiras 10mm	União de cravar IP20 c/ 4 fios * Para fitas de 10mm Unión para crimpar IP20 c/ 4 hilos * Para tiras 10mm	União de cravar IP20 c/ 5 fios * Para fitas de 12mm Unión para crimpar IP20 c/ 5 hilos * Para tiras 12mm
Ref. 221411	Ref. 221412	Ref. 221422	Ref. 221433	Ref. 224219.1
União angular de cravar IP20 c/ 2 fios * Para fitas de 8mm Unión angular para crimpar IP20 c/ 2 hilos * Para tiras 8mm	União angular de cravar IP20 c/ 2 fios * Para fitas de 10mm Unión angular para crimpar IP20 c/ 2 hilos * Para tiras 10mm	União angular de cravar IP20 c/ 4 fios * Para fitas de 10mm Unión angular para crimpar IP20 c/ 4 hilos * Para tiras 10mm	União angular de cravar IP20 c/ 5 fios * Para fitas de 12mm Unión angular para crimpar IP20 c/ 5 hilos * Para tiras 12mm	União IP20 p/ 2 fios * Para fitas de 10mm Unión IP20 p/ 2 hilos * Para tiras 10mm



Consulte fichas técnicas, certificados e ficheiros IES (Dialux) no noso website.

Consulta ficha técnica, certificados y expedientes IES (Dialux) en nuestra página web.

A modern living room with a large window and a potted plant. The room features a grey sofa, a black coffee table, and a large potted plant. The window looks out onto a balcony with a covered outdoor seating area. The ceiling has a warm, orange glow.

FONTES DE ALIMENTAÇÃO

Fuentes de Alimentación

NORMAS E LEGISLAÇÃO

REGLAMENTOS Y NORMAS

NORMAS E LEGISLAÇÃO DE FONTES DE ALIMENTAÇÃO

As fontes LED utilizam-se para muitos tipos de aplicações. Todos os países estão a começar a definir as suas próprias regulamentações de segurança EMC e PF.

A maioria dos utilizadores requerem uma tensão de saída entre 24-56V. E isto deve-se em parte ao limite SELV (<DC 60V), aos IC driver que trabalham com uma tensão limitada e à consideração de eficiência global.

Quando trabalhamos em ambientes secos, húmidos ou molhados, a fonte pode ser para integrar ou independente. As series CLG/HLG/CEN cumprem com os requisitos de segurança em ambos os tipos.

Os cabos do sistema, o cabo de terra, os controladores IC driver, afectam a EMC de todo o sistema. Uma vez terminada a montagem deve voltar a confirmar o EMC do sistema.

RESUMO GERAL DE NORMAS

A nível europeu as regulamentações exigidas para as fontes de alimentação a LED são, essencialmente, as seguintes:

SEGURANÇA

- _ EN61347-1 (controlo da lâmpada – requisito genérico);
- _ EN61347-2-13 (controlador do LED AC/DC).

EMC

- _ HARMÓNICAS: EN61000-3-2 Classe C (correntes harmónicas);
- _ EMI condução e radiação: EN55015;
- _ EMS Imunidade: EN61547 (requisito similar à ITE);
- ITE = Information Technology Equipment (Equipamentos de tecnologia da informação).

Regulamentação LED Geral – Resumo

- _ EN61347-1/EN61347-2-13 - independente (controlo LED);
- _ UL1310 Classe 2 - Fonte de potência limitada <100VA <=5A;
- _ UL1012 - 277Vac (Potência nominal >100VA);
- _ UL879 - 277Vac (Para lista SAM);
- _ UL Sujeta a 8750 - USA - Produtos de Iluminação LED;
- _ CNS15233 - Regulação de Taiwan para a iluminação pública por LED;
- _ EN61000-3-2 Classe C - Correntes harmónicas;
- _ EMI: EN55015 a Critérios de teste distintos da ITE; (Perturbações radioeléctricas para iluminação)
- _ EMS: EN61547 /4KV Surge a Requisitos de imunidade para iluminação pública;
- _ Nível IP /UL50/NEMA a Grau de protecção;
- _ EN62384 a Dispositivos de controlo electrónicos para módulos LED.

REGLAMENTOS Y NORMAS DE FUENTES DE ALIMENTACIÓN

Las fuentes LED se utilizan para muchos tipos de aplicaciones. Todos los países están empezando a definir sus propias normas de seguridad EMC y PF.

La mayoría de los usuarios requieren un voltaje de salida entre 24 y 56 V. Y esto se debe en parte al límite SELV (<DC 60V), los circuitos integrados del controlador que funcionan con un voltaje limitado y la consideración de la eficiencia general.

Cuando se trabaja en ambientes secos, húmedos o mojados, la fuente puede ser integrada o independiente. La serie CLG/HLG/CEN cumple con los requisitos de seguridad de ambos tipos.

Los cables del sistema, el cable de tierra, los controladores del controlador IC, afectan la EMC de todo el sistema. Una vez que se completa el ensamblaje, debe reconfirmar la EMC del sistema.

RESUMEN DE NORMAS

A nivel europeo, la normativa exigida para las fuentes de alimentación LED es esencialmente la siguiente:

LA SEGURIDAD

- _ EN61347-1 (control de lámparas - requisito genérico);
- _ EN61347-2-13 (controlador do LED AC/DC).

EMC

- _ HARMÓNICAS: EN61000-3-2 Classe C (corrientes armónicas);
- _ EMI conducción y radiación: EN55015;
- _ EMS Imunidade: EN61547 (requisito similar à ITE);
- ITE = Information Technology Equipment (equipo de tecnología de la información).

Reglamento General LED – Resumen

- _ EN61347-1/EN61347-2-13 - independiente (control LED);
- _ UL1310 Clase 2: fuente de alimentación limitada <100VA <=5A;
- _ UL1012 - 277Vac (Potencia nominal >100VA);
- _ UL879 - 277Vac (Para lista SAM);
- _ UL Sujeto a 8750 - EE. UU. - Productos de iluminación LED
- _ CNS15233 - Reglamento de Taiwán para el alumbrado público LED;
- _ EN61000-3-2 Clase C - Corrientes armónicas;
- _ EMI: EN55015 a Criterios de prueba de ITE distintos; (Perturbaciones de radio para iluminación)
- _ EMS: EN61547 /4KV Aparecen los requisitos de inmunidad para el alumbrado público;
- _ Nível IP /UL50/NEMA a Grado de protección;
- _ EN62384 a Dispositivos de control electrónico para módulos LED.

COMO CALCULAR A POTÊNCIA DA FONTE A UTILIZAR

Para determinar a fonte a utilizar deverá ter em conta três fatores:

1 TENSÃO (VDC) DA FITA DE LED

Esta deverá ser a mesma que utilizar na fita de LED (12Vdc ou 24Vdc)

2 POTÊNCIA POR MT DA FITA DE LED

Para o cálculo da potência devemos usar a seguinte fórmula:

Potência da fonte = (Potência da fita por metro X nº de metros a instalar) + 20%.

Caso não exista a potência igual ao resultado obtido, deverá optar pela potência seguinte.

3 LOCAL DE INSTALAÇÃO DA FONTE

Deverá ter em conta:

- **Grau de humidade** - isto determinará a proteção da fonte
(IP20 – sem proteção estanque; IP67 – totalmente estanque).
- **Utilização** - para uma utilização intensa deverão ser utilizadas fontes com uma garantia superior.

Drive CV: Tensão constante 12Vdc-24Vdc
Potência variável. (Watts)

Drive CC: Corrente constante (ex: 350mA)
Tensão variável. (voltagem = Vdc)

CÓMO CALCULAR LA POTENCIA DE LA FUENTE A UTILIZAR

Para determinar a fonte a utilizar deverá ter em conta três fatores:

1 TENSÃO (VDC) DA FITA DE LED

Esta deverá ser a mesma que utilizar na fita de LED (12Vdc ou 24Vdc)

2 POTÊNCIA POR MT DA FITA DE LED

Para o cálculo da potência devemos usar a seguinte fórmula:

Potência da fonte = (Potência da fita por metro X nº de metros a instalar) + 10%.

Caso não exista a potência igual ao resultado obtido, deverá optar pela potência seguinte.

3 LOCAL DE INSTALAÇÃO DA FONTE

Deverá ter em conta:

- **Grau de humidade** - isto determinará a proteção da fonte
(IP20 – sem proteção estanque; IP67 – totalmente estanque).
- **Utilização** - para uma utilização intensa deverão ser utilizadas fontes com uma garantia superior.

Drive CV: Tensão constante 12Vdc-24Vdc
Potência variável. (Watts)

Drive CC: Corrente constante (ex: 350mA)
Tensão variável. (voltagem = Vdc)

EXEMPLO DE UMA FONTE COM UL1310 CLASSE 2

EJEMPLO DE UNA FUENTE DE ALIMENTACIÓN CON UL1310 CLASE 2

110 Proteção contra excesso de aquecimento para prevenir que a caixa em nenhum momento possa superar os 100°C / 110°C / 120°C, de modo a evitar possíveis incêndios.
Protección contra sobrecalentamiento para evitar que la caja supere los 100°C / 110°C / 120°C en cualquier momento, para evitar posibles incendios.

F Adequado para montar directamente sobre superficies inflamáveis tais como madeira (>2mm)
Apto para montaje directo sobre superficies inflamables como madera (>2 mm)

LPS Fonte de energia limitada - Limited Power Source.
Fuente de poder limitada - Limited Power Source.

M M Baseado na VDE0710-14, pode ser instalado dentro de um material inflamável tal como uma caixa de madeira.
Determina a distância mínima entre a fonte e os laterais da caixa inflamável.
Basado en VDE0710-14, se puede instalar dentro de un material inflamable como una caja de madera. Determina la distancia mínima entre la fuente y los lados de la caja inflamable.

**t:80°C
t:40°C** Funciona à plena carga até 40°C e a temperatura da sua superfície não superará < 80 °C.
Funciona a plena carga hasta 40°C y su temperatura superficial no superará los < 80°C.

SELV Baseada na EN61347, Vo< 34Vpico/48VDC.
Baseada na EN61347, Vo< 34Vpico/48VDC.



FONTE IP20
FUENTE

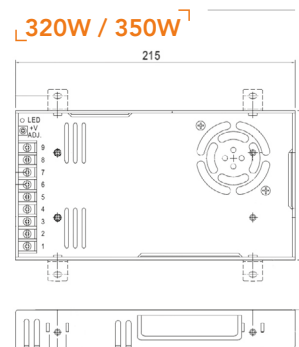
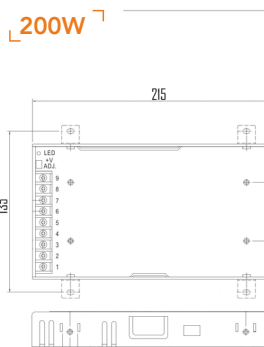
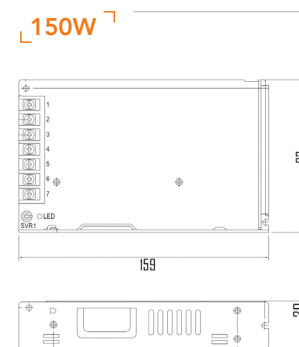
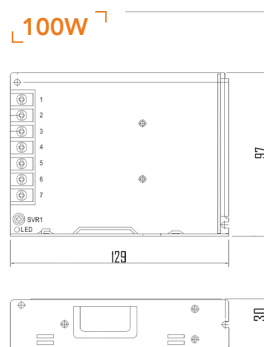
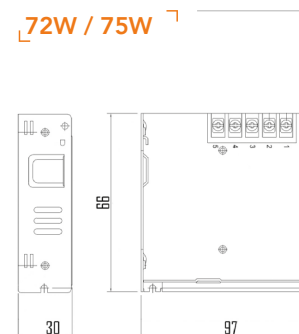
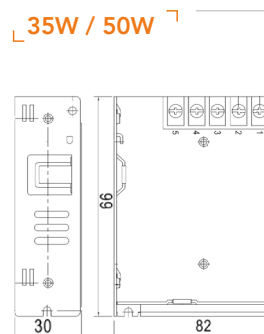
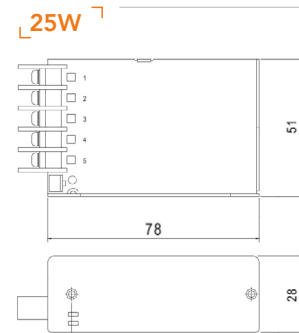
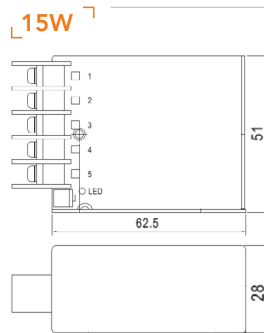

Modelo	Ref.	Input	Tensão Tensión	Potência Potencia
RS	201171.115	85-264Vac	12V	15W
	201171.125	88-264Vac	12V	25W
	201161.135	85-264Vac	12V	35W
LRS	201161.150	85-264Vac	12V	50W
	201161.175	85-264Vac	12V	72W
	201161.1100	85-264Vac	12V	100W
RSP	201161.1150	85-132/170-264	12V	150W
	201161.1350	90-132/180-264	12V	348W
	201161.1200	90-132/180-264	12V	200W
UHP	201161.1320	88-264Vac	12V	320W
	201371.1350	90-264Vac	12V	350W
	201371.1500	90-264Vac	12V	500W
RS	201371.1750	90-264Vac	12V	720W
	201171.215	85-264Vac	24V	15W
	201171.225	88-264Vac	24V	25W
LRS	201161.235	85-264Vac	24V	35W
	201161.250	85-264Vac	24V	50W
	201161.275	85-264Vac	24V	75W
RSP	201161.2100	85-264Vac	24V	100W
	201161.2150	85-132/170-264	24V	150W
	201701.2200	90-132/180-264	24V	200W
RSP	201161.2350	90-132/180-264	24V	350W
	201161.7600	90-132/180-264	48V	600W
	201161.2200	90-132/180-264	24V	200W
UHP	201161.2320	88-264Vac	24V	320W
	201371.2350	90-264Vac	24V	350W
	201371.2500	90-264Vac	24V	500W
	201371.2750	90-264Vac	24V	751W

PFC ATIVO

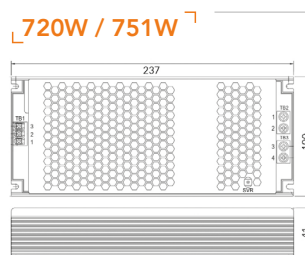
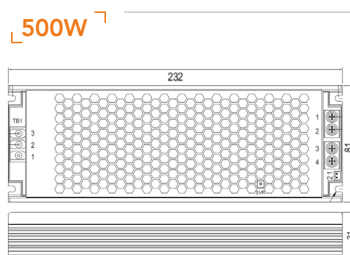
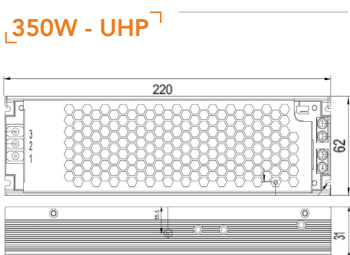

NOTA:
Outras potências e tensões disponíveis por consulta.
Otras potencias y tensiones disponibles bajo pedido.



FONTE IP20
FUENTE



Modelo	Ref.	Input	Tensão Tensión	Potência Potencia
LS	201561.16	176-264Vac	12V	6W
	201561.26	176-264Vac	24V	6W

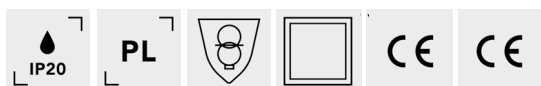
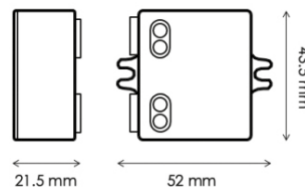

Modelo	Ref.	Input	Tensão Tensión	Potência Potencia
SS - MB	201561.112	198-264Vac	12V	12W
	201561.118	176-264Vac	12V	18W
	201561.212	198-264Vac	24V	12W
	201561.218	176-264Vac	24V	18W

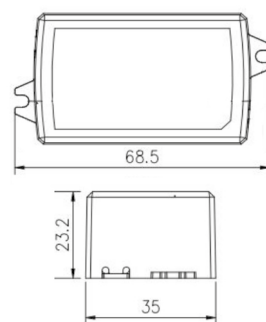

Modelo	Ref.	Input	Tensão Tensión	Potência Potencia	Dimensões Dimensiones
LS	201561.130	198-264Vac	12V	30W	160x42x30mm
	201561.160	176-264Vac	12V	60W	187x42x30mm
	201561.175	176-264Vac	12V	75W	187x42x30mm
LS	201561.230	198-264Vac	24V	30W	160x42x30mm
	201561.260	176-264Vac	24V	60W	187x42x30mm
	201561.275	176-264Vac	24V	75W	187x42x30mm
	201561.2120	198-264Vac	24V	120W	268x42x30mm
	201561.2150	198-264Vac	24V	150W	268x42x30mm
	201561.2200	198-264Vac	24V	200W	168x38x30mm
	201561.2250	198-264Vac	24V	250W	168x38x30mm
	201561.775	198-264Vac	48V	75W	168x38x30mm
	201561.7150	198-264Vac	48V	150W	268x42x30mm
	201561.7200	198-264Vac	48V	200W	168x38x30mm
	201561.7250	198-264Vac	48V	250W	168x38x30mm

NOTA:
Imagem representativa.
Imagen representativa.





— FONTE IP20
FUENTE



Modelo	Ref.	Input	Tensão Tensión	Potência Potencia
UNTERPUTZDOSE	20122740	198-264Vac	12V	12W
	20122742	198-264Vac	24V	12W

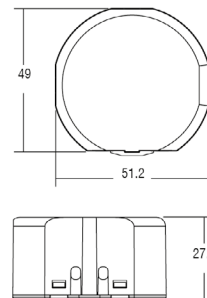

Modelo	Ref.	Input	Tensão Tensión	Potência Potencia
SLIM/U	20122444	90-264Vac	12V	13W
	20122442	90-264Vac	24V	13W

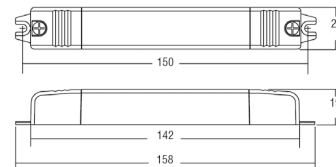

— FONTE LINEAR SLIM IP20
FUENTE LINEAL SLIM



Modelo	Ref.	Input	Tensão Tensión	Potência Potencia	Modelo	Ref.	Input	Tensão Tensión	Potência Potencia
EIP030	201281.130	198-264Vac	12V	30W	EIP030	201281.230	198-264Vac	24V	30W
US	201281.160	198-264Vac	12V	60W	US	201281.260	198-264Vac	24V	60W
US	201281.1100	198-264Vac	12V	100W	US	201281.2100	198-264Vac	24V	100W
					US	201281.2160	198-264Vac	24V	160W

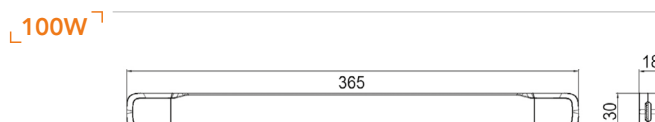
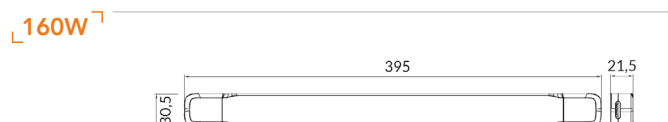
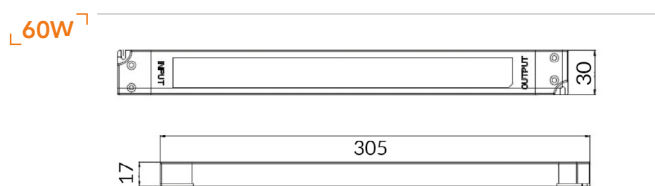
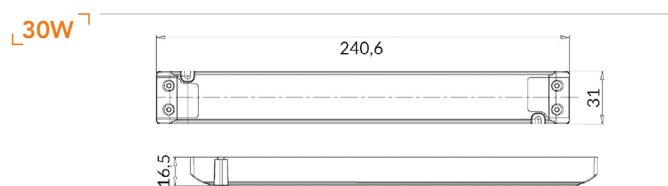



— FONTE LINEAR SLIM IP20

FUENTE LINEAL SLIM

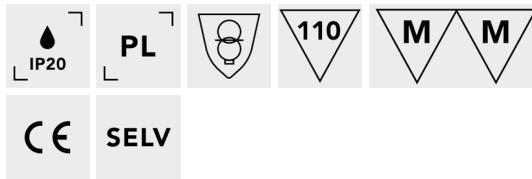

Modelo	Ref.	Input	Tensão Tensión	Potência Potencia
CV	201801.130	200-240Vac	12V	30W
	201801.160	198-264Vac	12V	60W

Modelo	Ref.	Input	Tensão Tensión	Potência Potencia
CV	201801.230	200-240Vac	24V	30W
	201801.260	198-264Vac	24V	60W
	201801.2100	180-264Vac	24V	100W
	201801.2150	180-264Vac	24V	150W
	201801.2200	220-240Vac	24V	200W
	201801.2240	220-240Vac	24V	240W

30W

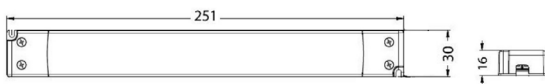

60W



200W

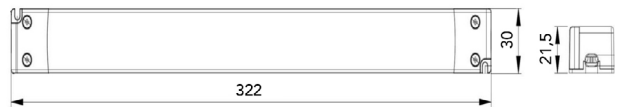

100W / 150W

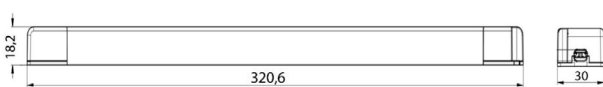

240W

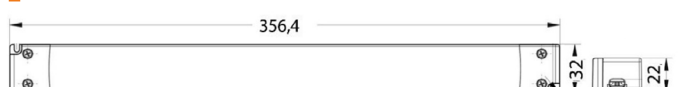

— FONTE LINEAR SLIM IP66

FUENTE LINEAL SLIM

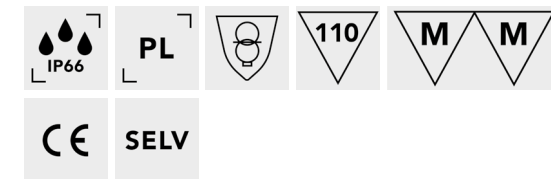

Modelo	Ref.	Input	Tensão Tensión	Potência Potencia
CV-L66	2018010.130	200-240Vac	12V	30W
	2018010.160	200-240Vac	12V	60W
	2018010.1100	200-240Vac	12V	100W
	2018010.1132	200-240Vac	12V	132W

Modelo	Ref.	Input	Tensão Tensión	Potência Potencia
CV-L66	2018010.230	200-240Vac	24V	30W
	2018010.260	200-240Vac	24V	60W
	2018010.2100	200-240Vac	24V	100W
	2018010.2150	200-240Vac	24V	150W

30W / 60W



100W / 132W / 150W

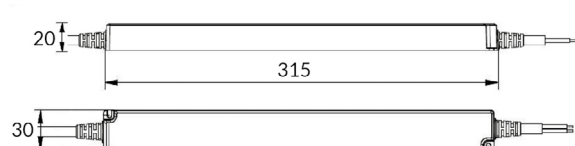



FONTE APV IP42

FUENTE APV

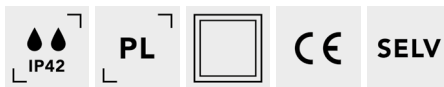

Modelo	Ref.	Input	Tensão Tensión	Potência Potencia
APV	201153.18	90-264Vac	12V	8W
	201153.112	90-264Vac	12V	12W
	201153.116	90-264Vac	12V	16W
APV	201153.125	90-264Vac	12V	25W
	201153.135	90-264Vac	12V	35W
APV	201153.28	90-264Vac	24V	8W
	201153.212	90-264Vac	24V	12W
	201153.216	90-264Vac	24V	16W
	201153.225	90-264Vac	24V	25W
	201153.235	90-264Vac	24V	35W

NOTA: Outras tensões disponíveis por consulta. Otros voltajes disponibles bajo pedido.

8W

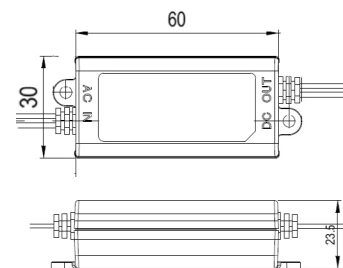

12W / 16W

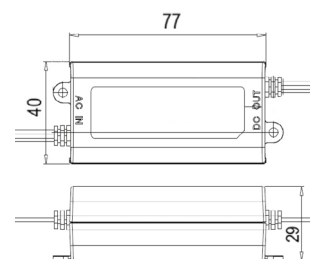

25W / 35W

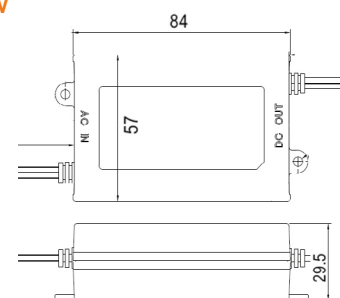

FONTE SH IP44

FUENTE SH

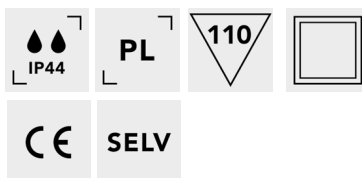

Modelo	Ref.	Input	Tensão Tensión	Potência Potencia
SH	201929.18	90-264Vac	12V	8W
	201929.116	90-264Vac	12V	16W
	201929.135	90-264Vac	12V	35W
SH	201929.28	90-264Vac	24V	8W
	201929.216	90-264Vac	24V	16W
	201929.235	90-264Vac	24V	35W



8W

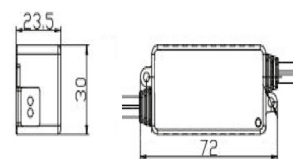

16W

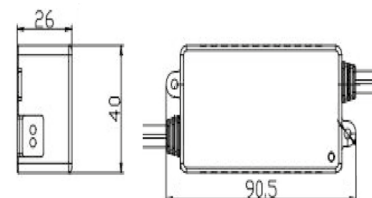

35W

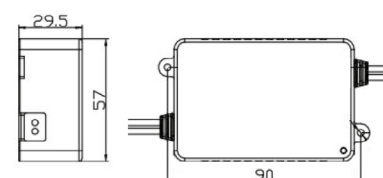

FONTE LPH IP67

FUENTE LPH

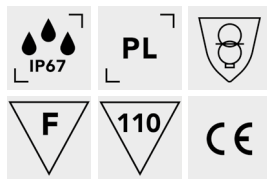

Modelo	Ref.	Input	Tensão Tensión	Potência Potencia
LPH	201176.118	180-264Vac	12V	18W
	201176.218	180-264Vac	24V	18W

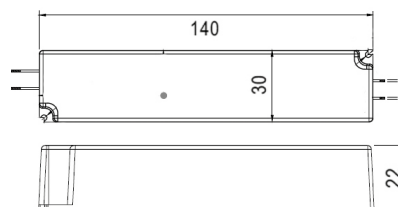

FONTE LPV IP67

FUENTE LPV



Modelo	Ref.	Input	Tensão Tensión	Potência Potencia	Modelo	Ref.	Input	Tensão Tensión	Potência Potencia
	201176.120	90-264Vac	12V	20W		201176.220	90-264Vac	24V	20W
	201176.135	90-264Vac	12V	35W		201176.235	90-264Vac	24V	35W
LPV	201176.160	90-264Vac	12V	60W	LPV	201176.260	90-264Vac	24V	60W
	201176.1100	90-264Vac	12V	100W		201176.2100	90-264Vac	24V	100W
	201176.1150	180-305Vac	12V	120W		201176.2150	90-264Vac	24V	150W

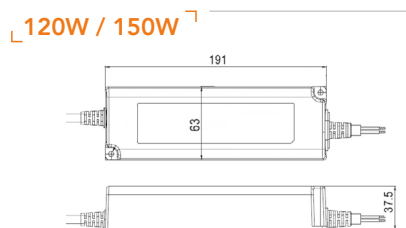
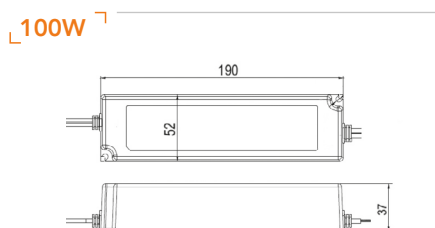
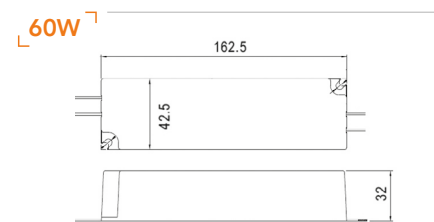
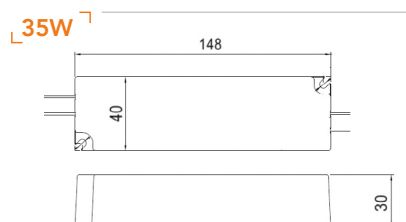
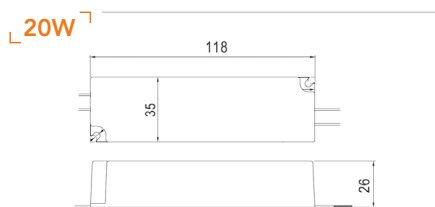

NOTA:
Outras tensões disponíveis por consulta.
Otros voltajes disponibles bajo pedido.

FONTE VTS IP67

FUENTE VTS



Modelo	Ref.	Input	Tensão Tensión	Potência Potencia
	2018352.124	198-264Vac	12V	24W
	2018352.140	198-264Vac	12V	40W
VTS	2018352.160	176-264Vac	12V	60W
	2018352.1100	176-264Vac	12V	100W
	2018352.1160	220-240Vac	12V	160W
	2018352.224	198-264Vac	24V	24W
	2018352.240	198-264Vac	24V	40W
VTS	2018352.260	176-264Vac	24V	60W
	2018352.2100	176-264Vac	24V	100W
	2018352.2160	176-264Vca	24V	160W

24W

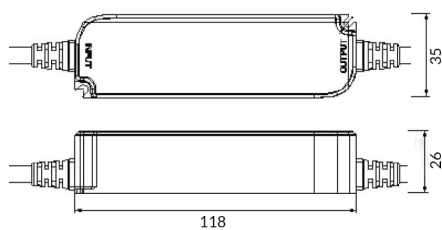

40W

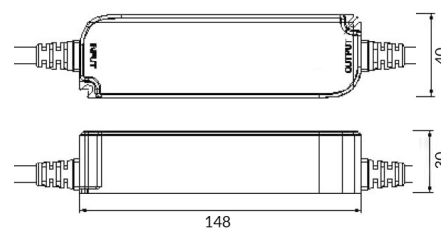

60W

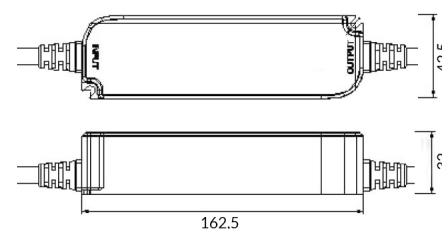

100W

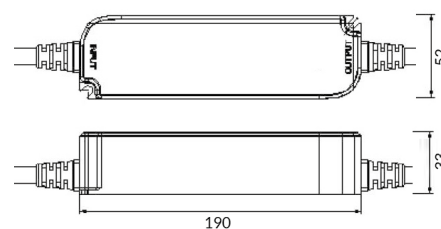

160W

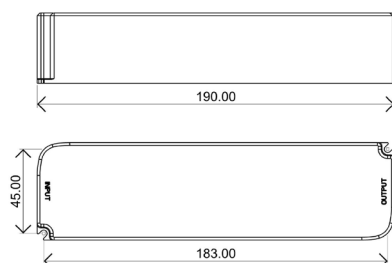

— FONTE LPF

FUENTE LPF

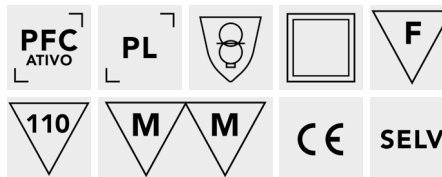

	Modelo	Ref.	Input	Tensão Tensión	Potência Potencia
	LPF	201116.116	90-305Vac	12V	16W
		201116.216	90-305Vac	24V	16W
	LPF	201116.125	90-305Vac	12V	25W
		201116.225	90-305Vac	24V	25W

40W / 60W

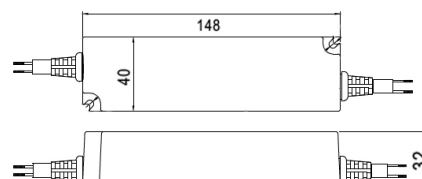

— FONTE NPF IP67

FUENTE NPF

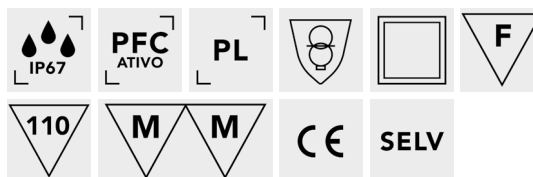

Modelo	Ref.	Input	Tensão Tensión	Potência Potencia	Modelo	Ref.	Input	Tensão Tensión	Potência Potencia
NPF	201266.140	90-305Vac	12V	40W	NPF	201266.240	90-305Vac	24V	40W
	201266.160	90-305Vac	12V	60W		201266.260	90-305Vac	24V	60W
	201266.190	90-305Vac	12V	90W		201266.290	90-305Vac	24V	90W
	201266.1120	90-305Vac	12V	120W		201266.2120	90-305Vac	24V	120W
	201266.1200	100-305Vac	12V	180W		201266.2200	100-305Vac	24V	200W

40W / 60W

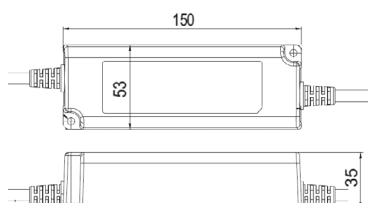

90W

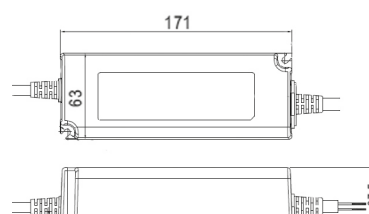

120W

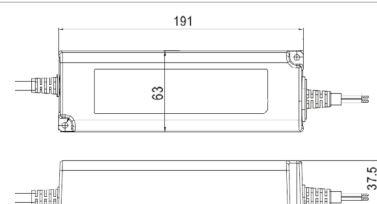

180W / 200W

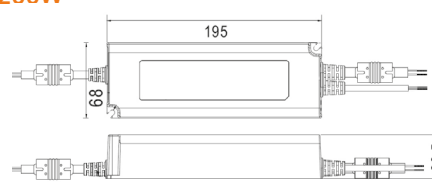

ILUMINAÇÃO DO WC

ILUMINACIÓN DO WC

O WC, apesar de ser um ambiente pequeno, necessita de uma iluminação bem idealizada, pois é um local onde são executadas várias tarefas que necessitam de acuidade visual. Um dos fatores mais importantes do ambiente é a correta escolha da fita de led e da fonte de alimentação. Uma boa iluminação oferece a condição ideal para realizar as atividades diárias sem esforço e com prazer.

A série de fontes de alimentação CVB é caracterizada pelo seu tamanho bastante compacto e modo de potência constante. Devido ao seu formato super slim e IP44, é ideal para zonas com humidade, como WC's (aplicação em espelhos, etc).

El WC, a pesar de ser un ambiente pequeño, necesita una iluminación bien diseñada, ya que es un lugar donde se realizan diversas tareas que requieren agudeza visual. Uno de los factores ambientales más importantes es la elección correcta de la tira LED y la fuente de alimentación. Una buena iluminación proporciona la condición ideal para realizar las actividades diarias sin esfuerzo y con placer.

La serie CVB de Fuentes de Alimentación se caracteriza por su tamaño muy compacto y modo de potencia constante. Por su formato superplano e IP44, es ideal para zonas con humedad, como WC (aplicación en espejos, etc).

FONTE CVB

Fuente CVB



— FONTE SLIM CVB IP44

FUENTE SLIM CVB

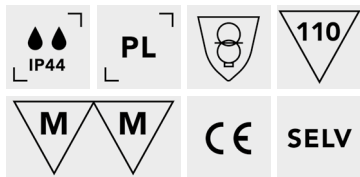

Modelo	Ref.	Input	Tensão Tensión	Potência Potencia
	201689.115	180-264Vac	12V	15W
	201689.130	200-240Vac	12V	30W
	201689.160	180-264Vac	12V	60W
CVB	201689.1100	200-240Vac	12V	100W
	201689.215	180-264Vac	24V	15W
	201689.230	200-240Vac	24V	30W
	201689.260	180-264Vac	24V	60W
	201689.2100	200-240Vac	24V	100W

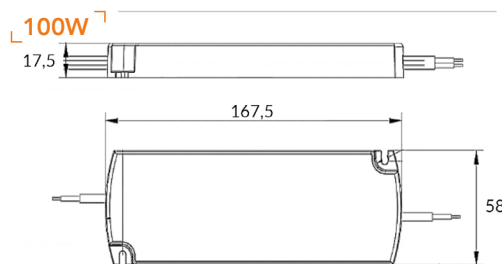
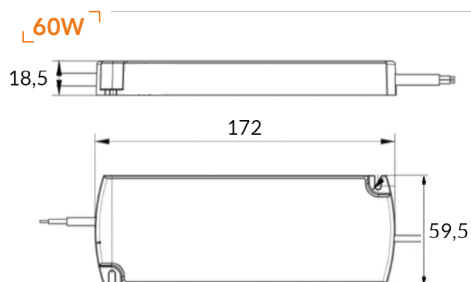
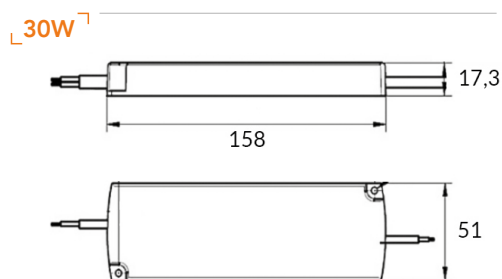

FONTE CV XLG IP67
FUENTE CV XLG



Modelo	Ref.	Input	Tensão Tensión	Potência Potencia
XLG	203535.1100	100-305Vac	12V	96W
	203535.1150	100-305Vac	12V	150W
	203535.1200	100-305Vac	12V	192W
	203535.275	100-305Vac	24V	75W
	203535.2100	100-305Vac	24V	96W
	203535.2150	100-305Vac	24V	150W
	203535.2200	100-305Vac	24V	200W
	203535.2320	100-305Vac	24V	312W
	203535.7240	100-305Vac	48V	240W
	203535.7320	100-305Vac	48V	312W

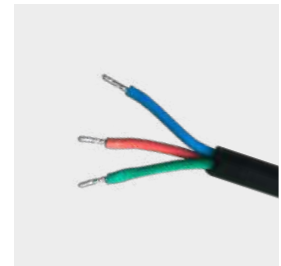

Cabo em silicone
Cable de silicona



Corpo em alumínio
cuerpo de aluminio

60W / 75W / 96W

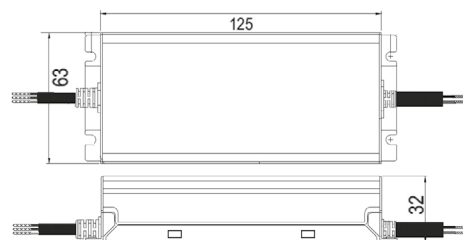

150W

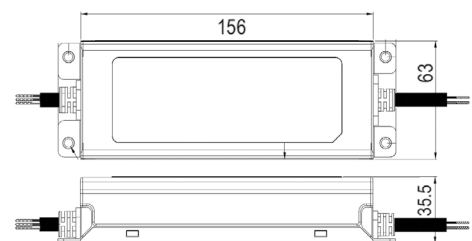

192W / 200W

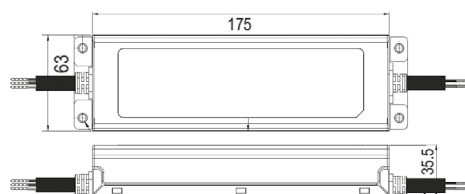

216W / 312W

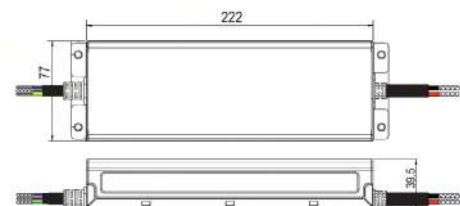

NOTA:

Outras tensões disponíveis por consulta. | Otros voltajes disponibles bajo pedido.

FONTE ELG / HLG IP65 IP67

FUENTE ELG / HLG

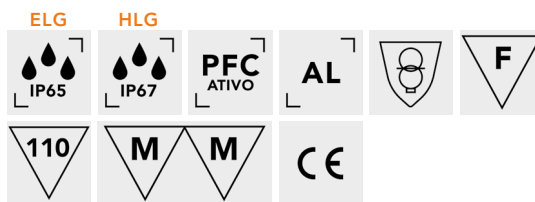

Modelo	Ref.	Input	Tensão Tensión	Potência Potencia	Modelo	Ref.	Input	Tensão Tensión	Potência Potencia
ELG	203205.1150	100-305Vac	12V	120W	ELG	203246.275	100-305Vac	24V	75W
ELG	203246.1200	100-305Vac	12V	192W	ELG	203246.2100	100-305Vac	24V	96W
HLG	203146.1240	90-305Vac	12V	192W	ELG	203246.2150	100-305Vac	24V	150W
ELG	203246.1300	100-305Vac	12V	264W	ELG	203246.2200	100-305Vac	24V	201W
HLG	203146.1320	100-305Vac	12V	264W	ELG	203246.2240	100-305Vac	24V	240W
HLG	203146.1600	90-305Vac	12V	480W	ELG	203246.2300	100-305Vac	24V	300W
					HLG	203146.2320	100-305Vac	24V	320W
					HLG	203146.2480	90-305Vac	24V	480W
					HLG	203146.2600	90-305Vac	24V	600W

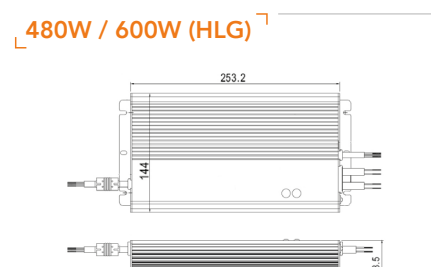
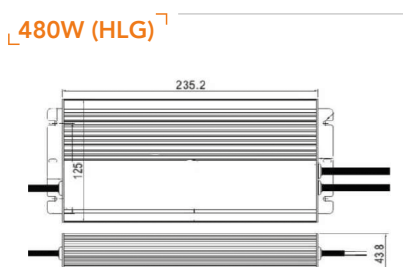
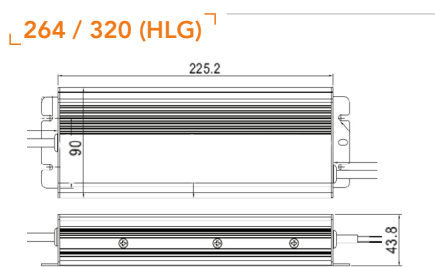
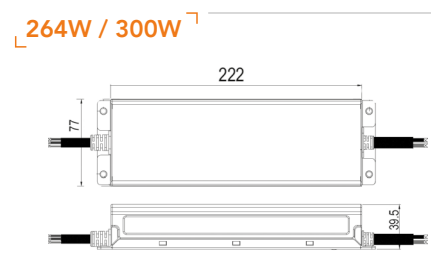
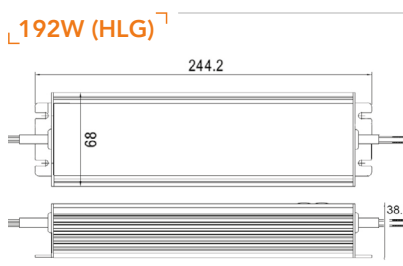
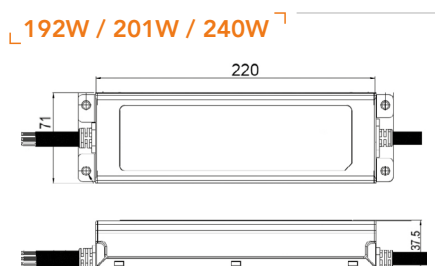
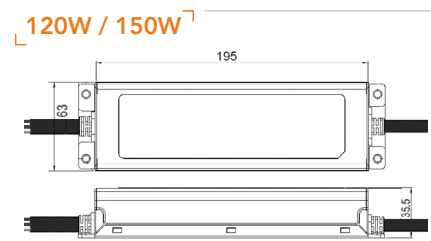
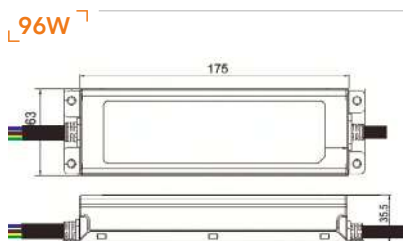
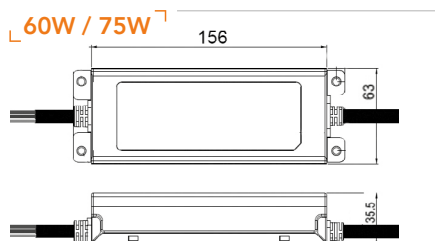

NOTA:
Outras tensões disponíveis por consulta. | Otros voltajes disponibles bajo pedido.

FONTE PARA CALHA DIN HDR IP20

FUENTE DE CARRIL DIN HDR



Modelo	Ref.	Input	Tensão Tensión	Potência Potencia	Modelo	Ref.	Input	Tensão Tensión	Potência Potencia
	201211.115	85-264Vac	12V	15W		201211.215	85-264Vac	24V	15W
	201211.130	85-264Vac	12V	24W		201211.230	85-264Vac	24V	36W
HDR	201211.160	85-264Vac	12V	54W	HDR	201211.260	85-264Vac	24V	60W
	201211.1100	85-264Vac	12V	90W		201211.2100	85-264Vac	24V	100W
	201211.1150	85-264Vac	12V	135W		201211.2150	85-264Vac	24V	150W

VISTA LATERAL

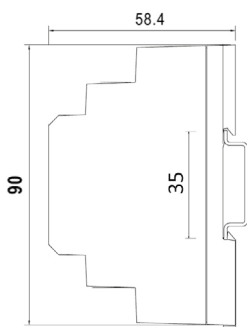

15W

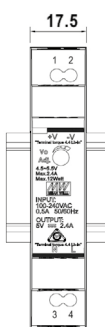

24W / 36W

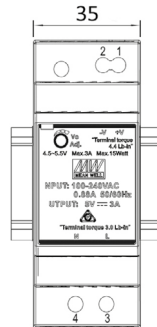

54W / 60W

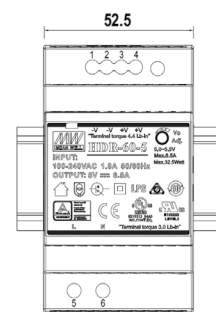

90W / 100W

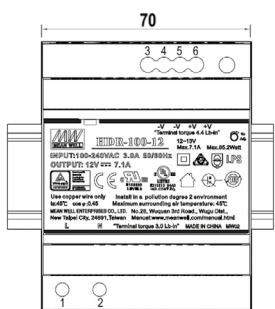

135W / 150W

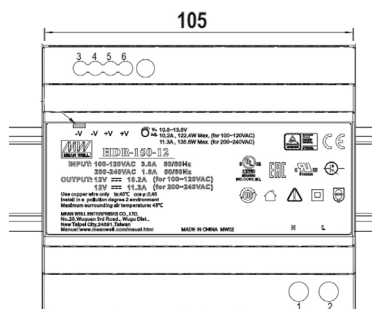

NOTA:
 Outras potências, tensões e modelos:
 DRP, NDR, MDR, HDR e SDR, disponíveis
 por consulta.
 Otras potencias, voltajes y modelos:
 DRP, NDR, MDR, HDR Y SDR, disponibles
 bajo pedido.



FONTES DIMÁVEIS

Fuentes Regulables



FONTE DIMÁVEL 2 EM 1 RF+PUSH IP20

FUENTE REGULABLE 2 EN 1



Modelo	Ref.	Input	Tensão Tensión	Potência Potencia
	2021881.240	100-240Vac	24V	40W
2 EM 1	2021881.275	200-240Vac	24V	75W
	2021881.2150	100-240Vac	24V	150W



_Funciona com o comando da serie ECO 2121244.DIM

_Funciona con el control de la serie ECO 2121244.DIM

40W

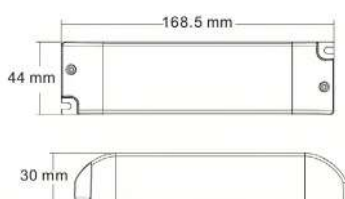

75W



150W

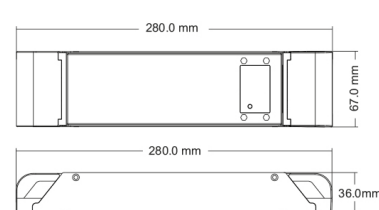

FONTE DIMÁVEL CV010 IP66

FUENTE REGULABLE CV010



Modelo	Ref.	Input	Tensão Tensión	Potência Potencia	Modelo	Ref.	Input	Tensão Tensión	Potência Potencia
	207516.1150	100-265Vac	12V	150W		207516.2150	100-265Vac	24V	150W
CV010	207516.1200	100-265Vac	12V	180W	CV010	207516.2200	100-265Vac	24V	200W
	207516.1320	200-240VAC	12V	320W		207516.2360	100-265Vac	24V	360W

150W / 180W / 200W

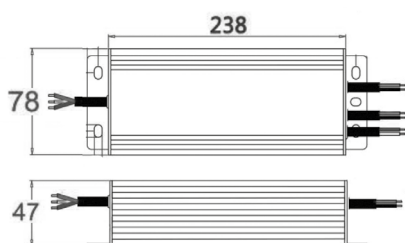

320W / 360W

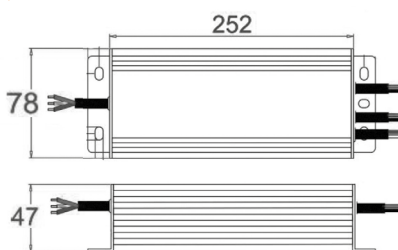

DESTAQUE | DESTACADO

Fontes dimáveis por comando 0/1-10V. Permite a regulação com qualquer regulador de 0/1-10V.

Fuentes Regulables de

Mando 0/1-10V. Permite la regulación con cualquier regulador 0/1-10V.

FONTE DIMÁVEL PWM IP67

FUENTE REGULABLE PWM

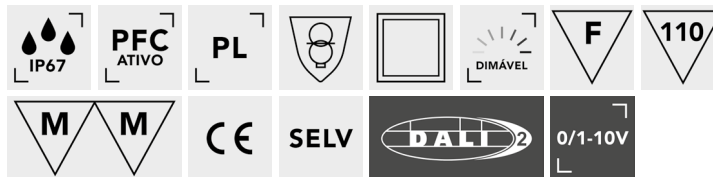

Modelo	Ref.	Input	Tensão Tensión	Potência Potencia
0/1-10V	20766.140	90-305Vac	12V	40W
	20766.160	90-305Vac	12V	60W
	20766.190	90-305Vac	12V	90W
	20766.1120	90-305Vac	12V	120W
	20766.1200	100-305Vac	12V	180W
DALI2	20766.160DA2	90-305Vac	12V	60W
	20766.190DA2	90-305Vac	12V	90W
	20766.1120DA2	90-305Vac	12V	120W
	20766.1200DA2	100-305Vac	12V	180W

Modelo	Ref.	Input	Tensão Tensión	Potência Potencia
0/1-10V	20766.240	90-305Vac	24V	40W
	2015966.260	90-305Vac	24V	60W
	20766.290	90-305Vac	24V	90W
	20766.2120	90-305Vac	24V	120W
	20766.2200	100-305Vac	24V	200W
DALI2	2015966.260DA2	90-305Vac	24V	60W
	20766.290DA2	90-305Vac	24V	90W
	20766.2120DA2	90-305Vac	24V	120W
	20766.2200DA	100-305Vac	24V	200W

0/1-10V	20766.740	90-305Vac	48V	40W
	20766.760	90-305Vac	48V	60W
	20766.790	90-305Vac	48V	90W
	20766.7120	90-305Vac	48V	120W
	20766.7200	100-305Vac	48V	200W
DALI2	2015966.760	110-305Vac	48V	60W
	20766.790DA2	90-305Vac	48V	90W
	20766.7200DA2	100-305Vac	48V	200W

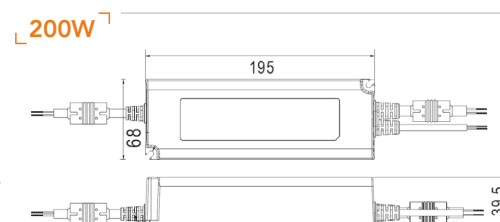
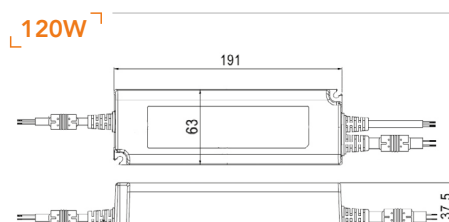
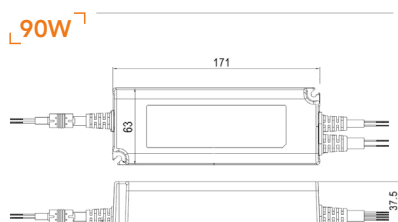
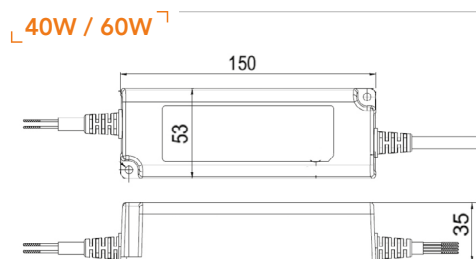

SUGESTÕES | SUGERENCIAS

Estas fontes são controladas pelo controlador de Ref. 2118237, pág.359. Fontes disponíveis para controlo direto em CASAMBI e KNX.

Estas fuentes están controladas por el controlador Ref. 2118237, página 359. Fuentes disponibles para el control directo en CASAMBI e KNX.



FONTE DIMÁVEL SPWM CONTROLO DIM/CTT/RGB/RGBW

FUENTE REGULABLE SPWM CONTROL DIM/CTT/RGB/RGBW

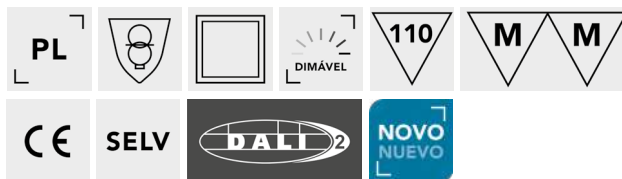

Modelo	Ref.	Input	Tensão Tensión	Corrente Corriente	Potência Potencia
DALI 2 DT6 1CH	2011052.175	100-305Vac	12V	6.3A	75W
	2011052.275	100-305Vac	24V	3.2A	75W
DALI 2 DT8 4CH	20331052.175	100-305Vac	12V	6.3A	75W*
	20331052.275	100-305Vac	24V	3.2A	75W*

*Seleccionável por Dip-Switch | Seleccionable mediante Dip-Switch

75W

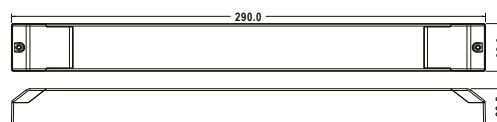

Modelo	Ref.	Input	Tensão Tensión	Corrente Corriente	Potência Potencia
DALI 2 DT6 1CH	2011052.1150	100-305Vac	12V	12.5A	150W
	2011052.2150	100-305Vac	24V	6.3A	150W
DALI 2 DT8 4CH	20331052.1150	100-305Vac	12V	12.5A	150W*
	20331052.2150	100-305Vac	24V	6.3A	150W*

*Seleccionável por Dip-Switch | Seleccionable mediante Dip-Switch

150W

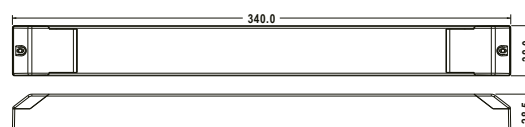

Modelo	Ref.	Input	Tensão Tensión	Corrente Corriente	Potência Potencia
DALI 2 DT6 1CH	2011052.2240	180-305Vac	24V	10A	240W
	2011052.7240	180-305Vac	48V	5A	240W
DALI 2 DT8 4CH	20331052.2240	180-305Vac	24V	10A	240W*
	20331052.7240	180-305Vac	48V	5A	240W*

*Seleccionável por Dip-Switch | Seleccionable mediante Dip-Switch

240W

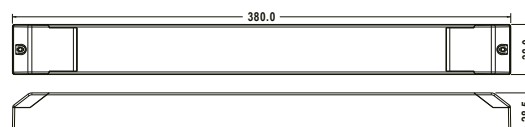



— FONTE DIMÁVEL IP20

FUENTE REGULABLE

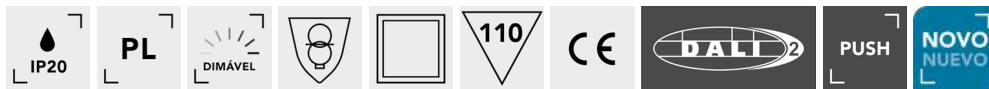

Ref.	Tensão Tensión	Corrente Corriente (Intervalo 50mA)	Potência Potencia
20271001.5742	2.5-49V	150-800mA	42W

42W

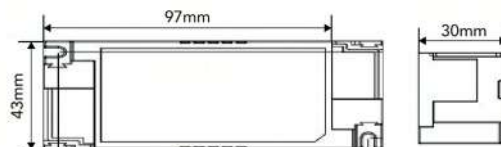

Ref.	Tensão Tensión	Corrente Corriente (Intervalo 50mA)	Potência Potencia
2019401.260	24V	2500mA	60W
2019401.2100	24V	4170mA	100W

60W

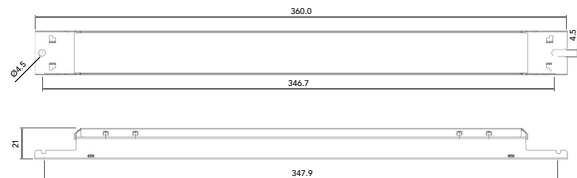

100W

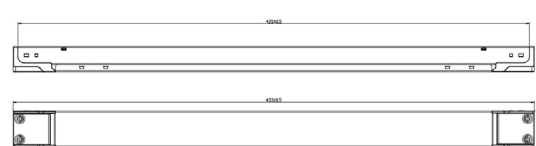

— FONTE DIMÁVEL SLIM CVPD2 IP66

FUENTE REGULABLE SLIM CVPD2

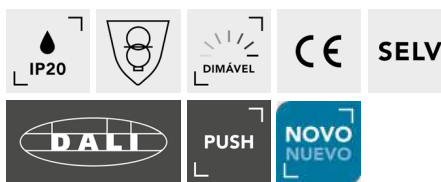

Modelo	Ref.	Input	Tensão Tensión	Potência Potencia
	2061011.2150	220-240Vca	24V	150W
	2061011.2200	220-240Vca	24V	200W
CVPD2	2061011.2240	220-240Vca	24V	240W
	2061011.7240	220-240Vca	48V	240W
	2061011.7200	100-265Vac	48V	200W

150W

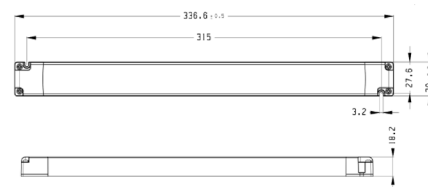

200W / 240W

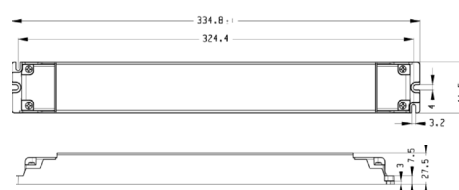



FONTE DIMÁVEL CVPD2 IP20

FUENTE REGULABLE CVPD2



Modelo	Ref.	Input	Tensão Tensión	Potência Potencia
CVPD2	206861.130*	100-277Vac	12V	30W
	206861.160*	100-277Vac	12V	60W

Modelo	Ref.	Input	Tensão Tensión	Potência Potencia
CVPD2	206861.230*	100-277Vac	24V	30W
	206861.260*	100-277Vac	24V	60W
	206861.730*	100-277Vac	48V	30W
	206861.760*	100-277Vac	48V	60W

*NOTA:
Alternativa às referências 206341.XX após descontinuação.
Alternativa a las referencias 206341.XX después de la discontinuación.

30W

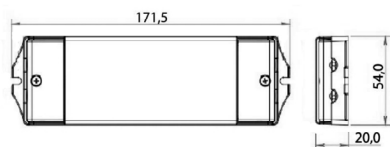

60W

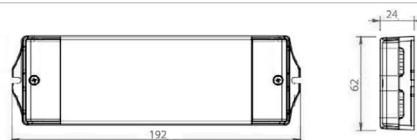

FONTE DIMÁVEL CVPD2 IP66

FUENTE REGULABLE CVPD2



Ref.	Input	Tensão Tensión	Potência Potencia	Dimensões Dimensiones
2068610.1100	110-277Vac	12V	100W	206x78x25mm
2068610.1120	110-277Vac	12V	120W	206x78x25mm
2068610.1150	100-277Vac	12V	150W	253x78x25mm
2068610.1200	100-277Vac	12V	200W	253x78x25mm
2068610.1300	100-277Vac	12V	300W	276x78x25mm
2068610.2100	110-277Vac	24V	100W	206x78x25mm
2068610.2120	110-277Vac	24V	120W	206x78x25mm
2068610.2150	100-277Vac	24V	150W	253x78x25mm
2068610.2200	100-277Vac	24V	200W	253x78x25mm
2068610.2300	100-277Vac	24V	300W	276x78x25mm
2068610.7100	110-277Vac	48V	100W	231x78x25,1mm
2068610.7150	100-277Vac	48V	150W	278x78x25,1mm
2068610.7200	100-277Vac	48V	200W	278x78x25,1mm
2068610.7300	100-277Vac	48V	300W	301x78x25,1mm

*NOTA:
Alternativa às referências 206345.XX após descontinuação.

Alternativa a las referencias 206345.XX después de la discontinuación.

FONTE DIMÁVEL UPOWERTEK IP66

FUENTE REGULABLE UPOWERTEK IP66



206976.2400	90-305 Vac	24V	400W	251x90x41,5mm
206976.2500	176-305 Vac	24V	500W	251x90x41,5mm

FONTE DIMÁVEL LS-DA IP20
FUENTE REGULABLE LS-DA

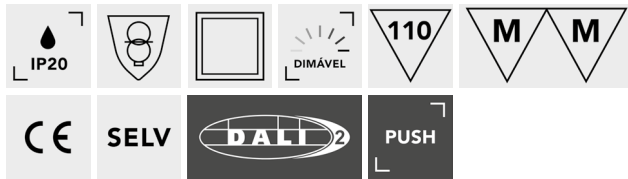

Modelo	Ref.	Input	Tensão Tensión	Potência Potencia
LS-DA	206561.245	220-240Vac	24V	45W
	206561.280	220-240Vac	24V	80W
	206561.2150	220-240Vac	24V	150W
	206561.2250	220-240Vac	24V	250W
LS DALI2 CCT	2019281.245	176-264Vac	24V	45W
	2019281.280	176-264Vac	24V	80W
	2019281.2150	198-264Vac	24V	150W

45W

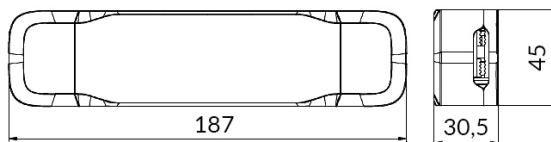

80W / 150W MODELO LS-DA

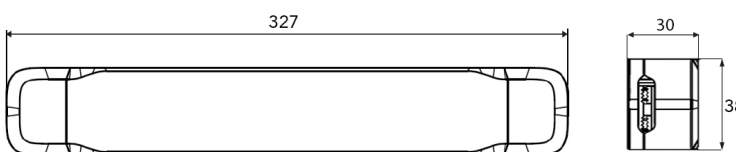

80W / 150W MODELO LS DALI2 CCT



250W





FONTE SLIM DIMÁVEL CVT IP20

FUENTE SLIM REGULABLE CVT

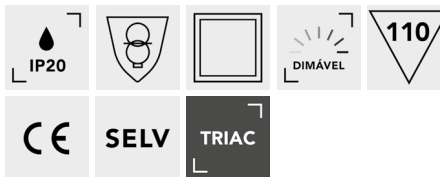

Modelo	Ref.	Input	Tensão Tensión	Potência Potencia
	205801.136	200-240Vac	12V	36W
	205801.160	200-240Vac	12V	60W
	205801.1100	200-240Vac	12V	100W
CVT-L20	205801.1150	200-240Vac	12V	150W
	205801.236	200-240Vac	24V	36W
	205801.260	200-240Vac	24V	60W
	205801.2100	200-240Vac	24V	100W
	205801.2150	200-240Vac	24V	150W

MODELO CVT SLIM

Fontes SLIM dimáveis no primário por TRIAC, compatíveis com os reguladores dímmer convencionais.

Fuentes SLIM Regulables en el primario por TRIAC, compatibles con reguladores regulable convencionales.

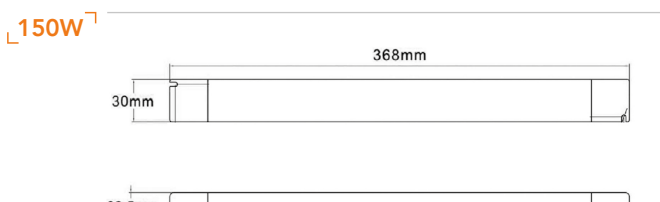
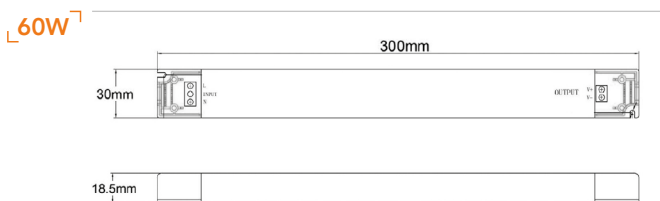
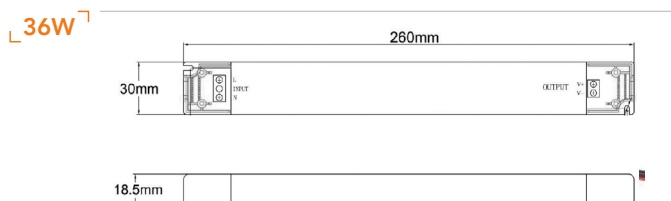

DIMMERS COMPATÍVEIS

REGULABLES COMPATIBLES

Marca	Ref.	Potência Máxima Potencia Máxima
Motako	211218.3400	200W
Motako	211244.3240	240W
Motako	2110226.3576	460W
Efapel	21217	5 a 150W
Efapel	21218	80W
Efapel	45218	80W
Casambi	2117229.3200	200W
Legrand Netatmo	752184	60W
Bitcino Netatmo	L4411CM2	60W

SUGESTÕES | SUGERENCIAS

Filtro de Proteção
230Vac 480W Triac
Filtro de Protección
Ref. 2238280.3480

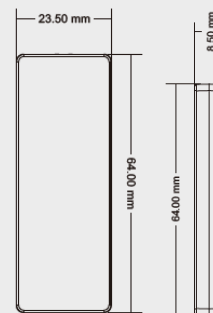

FONTE DIMÁVEL CVT IP20 FUENTE REGULABLE CVT



Modelo	Ref.	Input	Tensão Tensión	Potência Potencia
CVT	205313.130	200-240Vac	12V	30W
	205313.160	200-240Vac	12V	60W
	205313.230	200-240Vac	24V	30W
	205313.260	200-240Vac	24V	60W

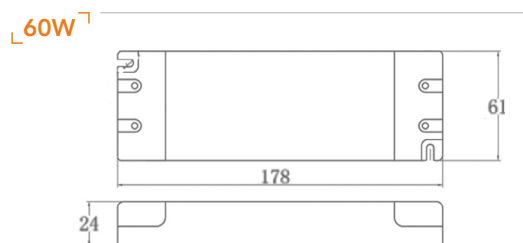
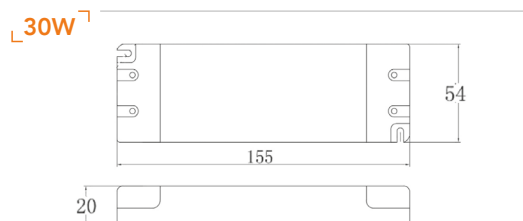

MODELO CVT

Fontes Dimáveis no primário por TRIAC, compatíveis com os reguladores dímmer convencionais.

Fuentes regulables en el primario por TRIAC, compatibles con reguladores regulable convencionales.

FONTE DIMÁVEL CVT IP66 FUENTE REGULABLE CVT

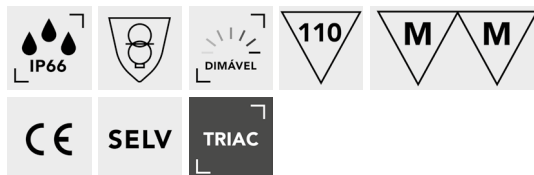

Modelo	Ref.	Input	Tensão Tensión	Potência Potencia	Modelo	Ref.	Input	Tensão Tensión	Potência Potencia
CVT	205313.1100	200-240Vac	12V	100W	CVT	205313.2100	200-240Vac	24V	100W
	205313.1150	200-240Vac	12V	150W		205313.2150	200-240Vac	24V	150W
	205313.1200	200-240Vac	12V	200W		205313.2200	200-240Vac	24V	200W
	205313.1300	200-240Vac	12V	300W		205313.2300	200-240Vac	24V	300W

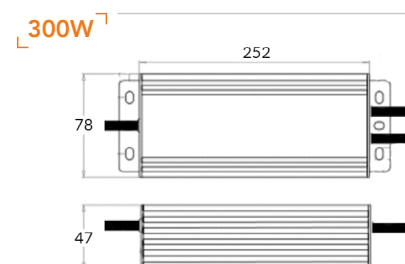
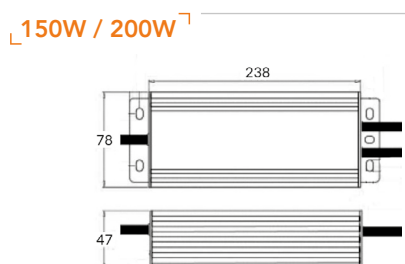
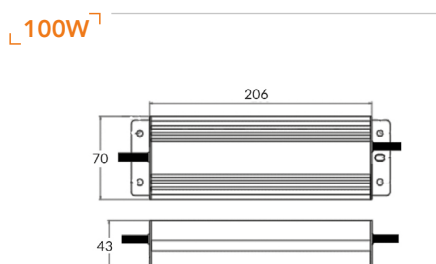



DRIVERS NÃO DIMÁVEIS

Controladores no Regulables

DRIVER CC APC IP42

DRIVER CC APC



Ref.	Tensão Tensión	Corrente Corriente	Potência Potencia
202233.1210	16-32V	250mA	8W
202233.171	11-23V	350mA	8W
202233.295	8-16V	500mA	8W
202233.12	6-11V	700mA	8W

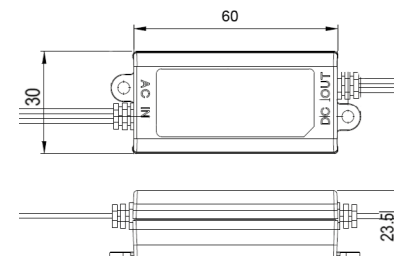

Ref.	Tensão Tensión	Corrente Corriente	Potência Potencia
202233.91*	9-36V	350mA	12W
202233.970	9-18V	700mA	12W

* Ideal para painéis de 3W a 12W
Ideal para paneles de 3W a 12W

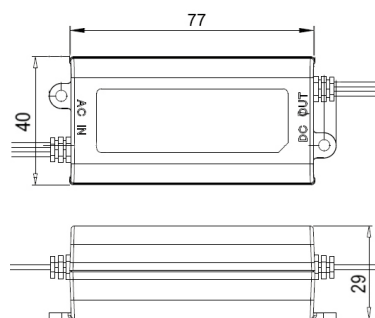

Ref.	Tensão Tensión	Corrente Corriente	Potência Potencia
202233.191	12-48V	350mA	16W
202233.252	9-24V	700mA	16W

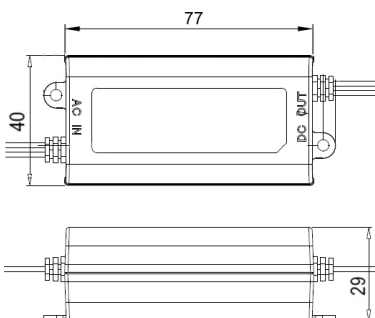

Ref.	Tensão Tensión	Corrente Corriente	Potência Potencia
202233.101*	25-70V	350mA	25W
202233.75	15-50V	500mA	25W
202233.1270	11-36V	700mA	25W

* Ideal para painéis de 12W a 24W
Ideal para paneles de 12W a 24W

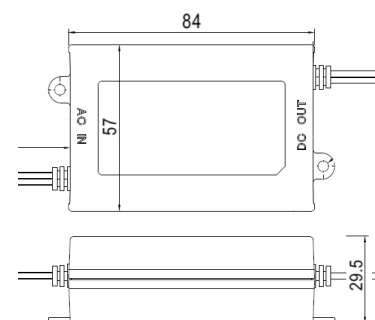

DRIVER CC APC IP42
DRIVER CC APC



Ref.	Tensão Tensión	Corrente Corriente	Potência Potencia
202233.181	28-100V	350mA	35W
202233.105	25-70V	500mA	35W
202233.770	15-50V	700mA	35W
202233.533	11-33V	1050mA	35W

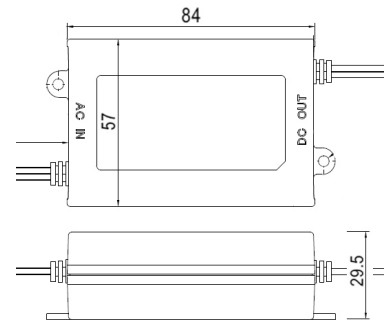

DRIVER CC MINI
DRIVER CC MINI



Ref.	Output	Corrente Corriente	Potência Potencia
202135.635	2.5-8V	500mA	4W

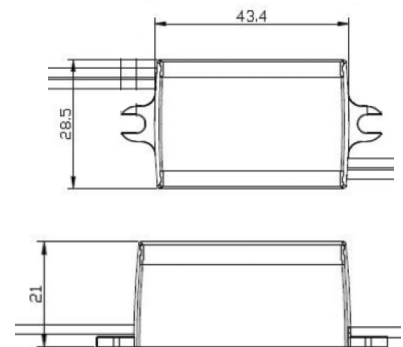

SB

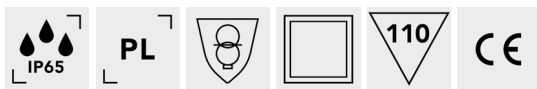

Ref.	Output	Corrente Corriente	Potência Potencia
202405.721	2.5-10V	350mA	3,5W

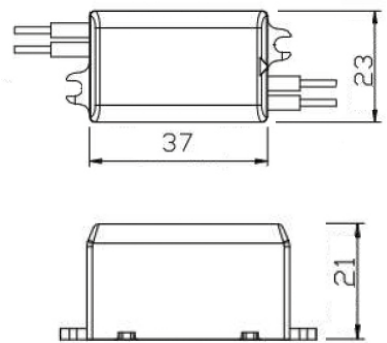

SB



Ref.	Output	Corrente Corriente	Potência Potencia
202405.734	2.5-4.5V	700mA	3,2W

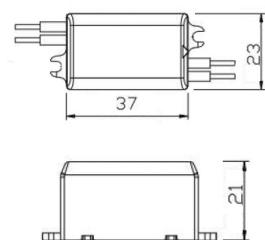

DRIVER CC MINI IP20

DRIVER CC MINI

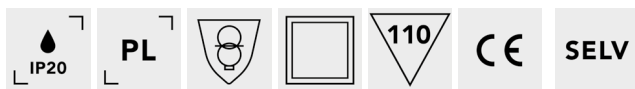

SH LB-G



Ref.	Tensão Tensión	Corrente Corriente	Potência Potencia
202921.851	12-21V	350mA	6W
202921.862	5,5-10,5V	700mA	6W

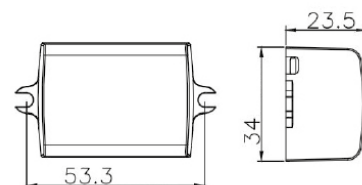

Ref.	Tensão Tensión	Corrente Corriente	Potência Potencia
202841.9960	2,5-20Vdc	100-700mA	7W

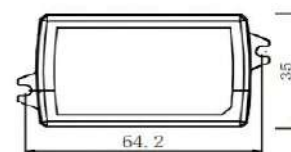

SH LB-G



Ref.	Tensão Tensión	Corrente Corriente	Potência Potencia
202921.871	20-36V	350mA	12W
202921.882	11-18,5V	700mA	12W

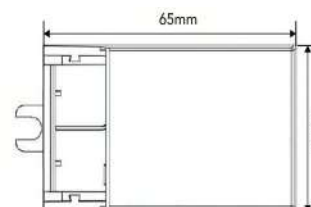

Ref.	Tensão Tensión	Corrente Corriente	Potência Potencia
2019801.6098	2,5-46Vcc	100-700mA	15W

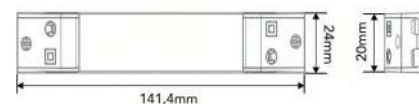

DRIVER CC IP20

DRIVER CC

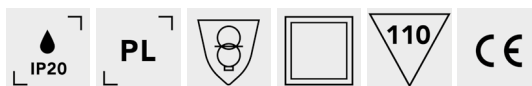

FLS-LD



Ref.	Tensão Tensión	Corrente Corriente (Intervalo 50mA)	Potência Potencia
202401.7439	10-42V	150-500mA	6,3-21W

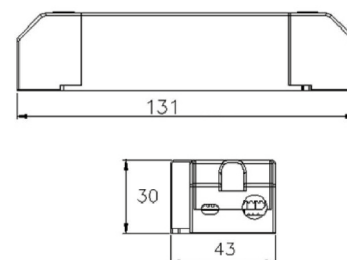

FLS-LD-ADV



Ref.	Tensão Tensión	Corrente Corriente (Intervalo 50mA)	Potência Potencia
202451.7735	9-52V	300-800mA	15,6 - 41,6W
	9-42V	850-1000mA	37,5 - 42W
	9-40V	1050mA	42W

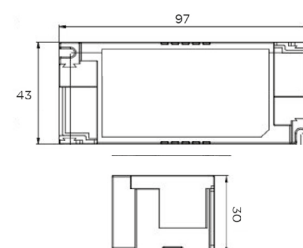

DRIVER CC IP67
DRIVER CC



LPHC



Ref.	Tensão Tensión	Corrente Corriente	Potência Potencia
20286.41	6-48V	350mA	16,8W
20286.202	6-25V	700mA	17,5W



LPC



Ref.	Tensão Tensión	Corrente Corriente	Potência Potencia
202186.41	9-48V	350mA	16,8W
202186.442	9-30V	700mA	21W



LPC



Ref.	Tensão Tensión	Corrente Corriente	Potência Potencia
202186.47	9-48V	700mA	33.6W
202186.443	9-30V	1050mA	31.5W
202186.2515	9-24V	1400mA	33.6W



LPC



Ref.	Tensão Tensión	Corrente Corriente	Potência Potencia
202186.43	9-48V	1050mA	50.4W
202186.415	9-42V	1400mA	58.8W

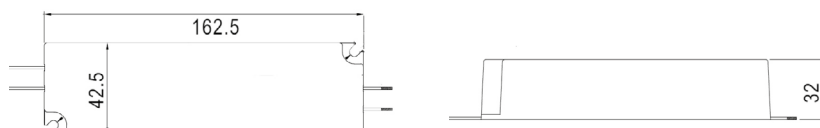

NOTA: Outras potências e tensões disponíveis por consulta. Otras potencias y voltajes disponibles bajo pedido.

DRIVER CC IP67

DRIVER CC



LPC

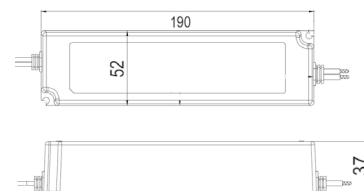

Ref.	Tensão Tensión	Corrente Corriente	Potência Potencia
202186.341	143-286V	350mA	100W
202186.352	72-143V	700mA	100W
202186.363	48-96V	1050mA	100W
202186.3715	36-72V	1400mA	100W
202186.157	24-48V	2100mA	100W

LPC

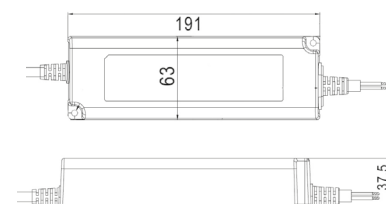

Ref.	Tensão Tensión	Corrente Corriente	Potência Potencia
202186.541	215-430V	350mA	150W
202186.302	107-215V	700mA	150W
202186.343	72-144V	1050mA	150W
202186.68	31-62V	2450mA	150W
202186.1527	24-48V	3150mA	150W

ELG

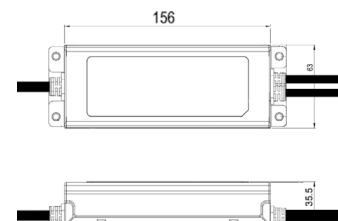

Ref.	Tensão Tensión	Corrente Corriente	Potência Potencia
202245.482	53-107V	700mA	75W

NOTA:

Outras potências e tensões disponíveis por consulta.
Otras potencias y voltajes disponibles bajo pedido.

DRIVER CC MINI (formato compacto) IP20

DRIVER CC MINI (formato compacto)



BULL/U



Ref.	Tensão Tensión	Corrente Corriente	Potência Potencia
20122604	5-40V	150mA	6W
20141133	2-36V	250mA	6W
20122596	2-11,5V	350mA	4W

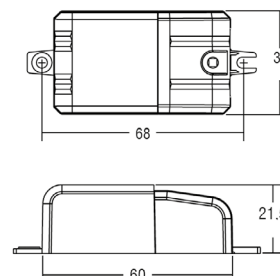

BMU



Ref.	Tensão Tensión	Corrente Corriente	Potência Potencia
20141070	2-34V	350mA	12W
20122794	2-24V	500mA	12W
20141074	2-17V	700mA	12W

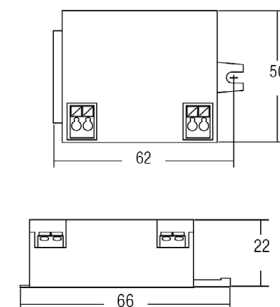

STM



Ref.	Tensão Tensión	Corrente Corriente	Potência Potencia
20122799	2-40V	150mA	6W
20127715	2-23V	350mA	8W
20122815	2-8,5V	700mA	6W

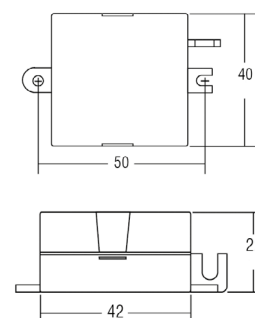

STC



Ref.	Tensão Tensión	Corrente Corriente	Potência Potencia
20141052	2-27V	350mA	9W
20122635	2-11,5V	500mA	6W

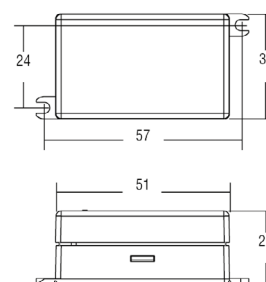

NOTA:: Outros modelos disponíveis por consulta. Otros modelos disponibles bajo pedido.

DRIVER CC STANDARD IP20

DRIVER CC STANDARD



DCC/HPFU



Ref.	Tensão Tensión	Corrente Corriente	Potência Potencia
20127713	2-41,5V	350mA	14,5W
20127712	2-16V	700mA	12W

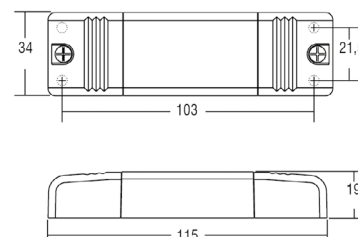

WU 2C



Ref.	Tensão Tensión	Corrente Corriente	Potência Potencia
20122248	3-40V	500mA	20W
20122236	2-21V	1500mA	20W

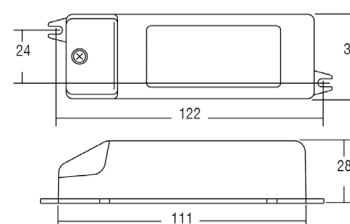

SLIM HPFU



Ref.	Tensão Tensión	Corrente Corriente	Potência Potencia
20141112	2-27V	500mA	14W

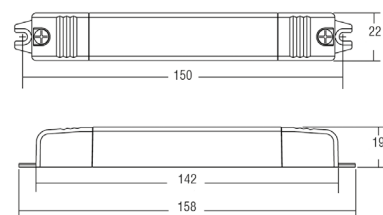

HPFU



Ref.	Tensão Tensión	Corrente Corriente	Potência Potencia
20141114IP	2-17V	700mA	11W

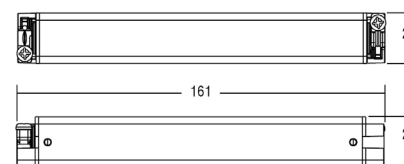

DRIVER CC MULTI-CORRENTE IP20

DRIVER CC MULTICORRIENTE

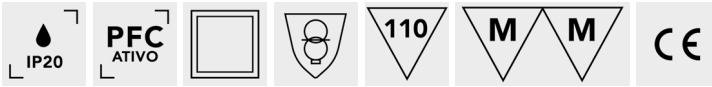

SQUARE 38 NFC



Ref.	Tensão Tensión	Corrente Corriente	Potência Potencia
20142024	10-48V	300-1050mA	3-38W

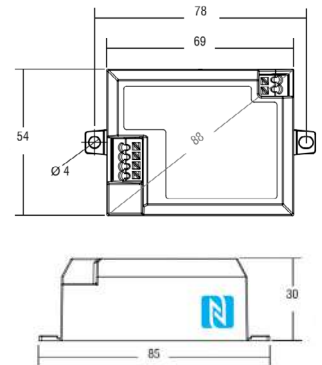

MP 15 HPFU



Ref.	Tensão Tensión	Corrente Corriente (Intervalo 20mA)	Potência Potencia
20127710	2-41,5V	60-360mA	2,5-15W

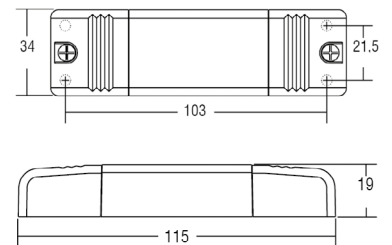

DCC HPFU



Ref.	Tensão Tensión	Corrente Corriente (Intervalo 50mA)	Potência Potencia
20127484N	3-44V	300-750mA	13-32W
	3-42V	800-1000mA	33-42W
	3-40V	1050mA	42W

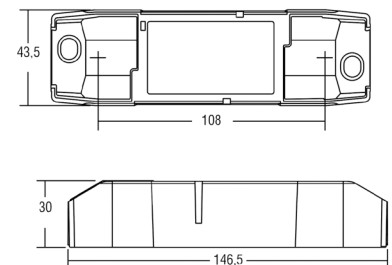

PROFESSIONALE HC



Ref.	Tensão Tensión	Corrente Corriente (Intervalo 50mA)	Potência Potencia
20127690	8-45V	650-700mA	29-31W
	8-44V	750mA	32W
	8-43V	800-950mA	34-40W
	8-42V	1000-1050mA	42-44W
	8-41V	1100mA	45W
	8-39V	1150mA	45W
	8-37,5V	1200mA	45W
	8-36V	1250mA	45W
	8-34,5V	1300mA	45W
	8-33V	1350mA	45W
	8-32V	1400mA	45W

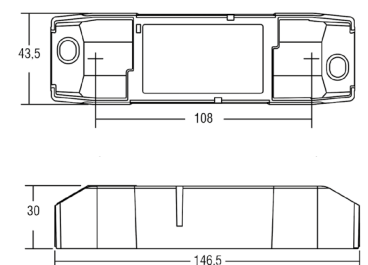

DRIVER CC MULTI-CORRENTE IP20

DRIVER CC MULTICORRIENTE

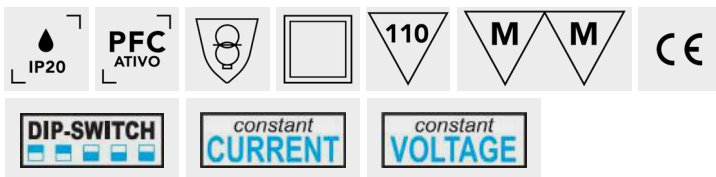

MP 32 K2



Ref.	Tensão Tensión	Corrente Corriente	Potência Potencia
20122200	2-47V	350mA	17W
	2-47V	500mA	24W
	2-47V	550mA	25W
	2-46V	700mA	32W
	2-24V	850mA	20W
	2-22V	900mA	20W
CV	10Vdc	1,05A	10W
	12Vdc	1,05A	13W
	24Vdc	1,05A	20W

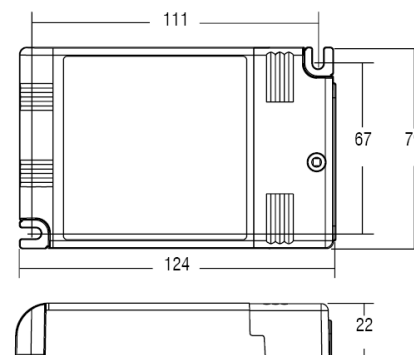

UNIVERSALE 20 LC



Ref.	Tensão Tensión	Corrente Corriente (Intervalo 40mA)	Potência Potencia
20122203	20-54V	100mA	5,4W
	10-54V	140mA	7,5W
	2-54V	180-380mA	10-20W

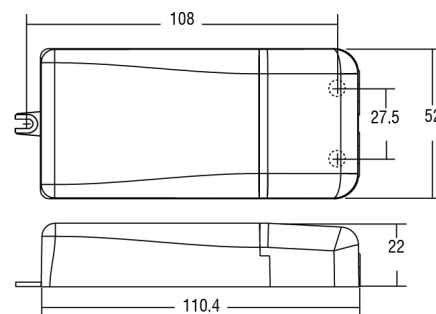

UNIVERSALE 20



Ref.	Tensão Tensión	Corrente Corriente	Potência Potencia
20122201	10-54V	250mA	13W
	2-54V	350mA	19W
	2-50V	400mA	20W
	2-44V	450mA	20W
	2-40V	500mA	20W
	2-37V	550mA	20W
	2-34V	600mA	20W
	2-29V	700mA	20W

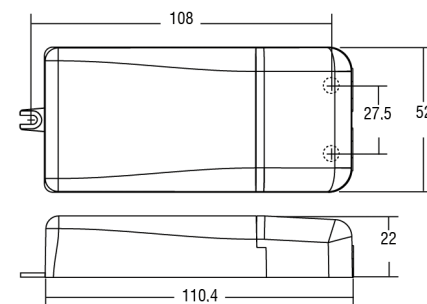

DRIVER LINEAR MULTI-CORRENTE IP20

DRIVER LINEAL MULTICORRIENTE

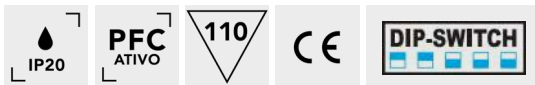

MPSE40350S

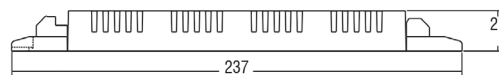
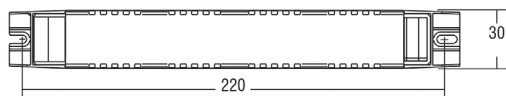

Ref.	Tensão Tensión	Corrente Corriente (Intervalo 10mA)	Potência Potencia
20127527	30-120V	200-330mA	24-39,6W
	20-118V	340mA	40W
	20-115V	350mA	40W

MP80 350SLI

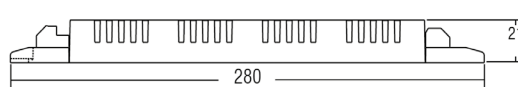
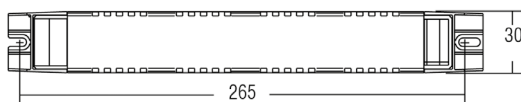

Ref.	Tensão Tensión	Corrente Corriente (Intervalo 10mA)	Potência Potencia
20122212	30-270V	200-290mA	54-78W
	30-266V	300mA	80W
	30-258V	310mA	80W
	30-250V	320mA	80W
	30-242V	330mA	80W
	30-235V	340mA	80W
	30-228V	350mA	80W

MPSE 55/350 SLIM

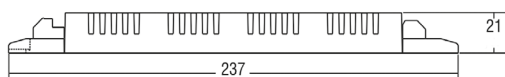
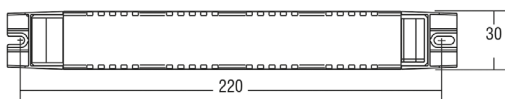

Ref.	Tensão Tensión	Corrente Corriente	Potência Potencia
20127524	70-260V	100mA	26W
	60-260V	117mA	30,5W
	60-260V	134mA	35W
	60-260V	150mA	39W
	60-260V	167mA	43,5W
	60-260V	184mA	48W
	40-260V	200mA	52W
	40-253V	217mA	55W
	40-235V	234mA	55W
	40-220V	250mA	55W
	40-206V	267mA	55W
	40-194V	284mA	55W
	40-183V	300mA	55W
	40-174V	317mA	55W
	40-165V	334mA	55W
	40-158V	350mA	55W

NOTA: Outros modelos disponíveis por consulta. Otros modelos disponibles bajo pedido.

DRIVER LINEAR MULTI-CORRENTE IP20
DRIVER LINEAL MULTICORRIENTE

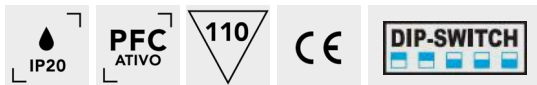

MPSE55/700S



Ref.	Tensão Tensión	Corrente Corriente (Intervalo 25mA)	Potência Potencia
20127526	50-140V	325-375mA	45,5-52,5W
	50-138V	400mA	55W
	50-130V	425mA	55W
	50-123V	450mA	55W
	50-116V	475mA	55W
	50-110V	500mA	55W
	50-105V	525mA	55W
	50-100V	550mA	55W
	50-96V	575mA	55W
	50-92V	600mA	55W
	50-88V	625mA	55W
	50-85V	650mA	55W
	50-82V	675mA	55W
	50-79V	700mA	55W

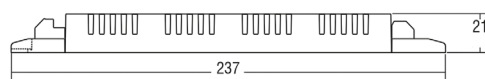
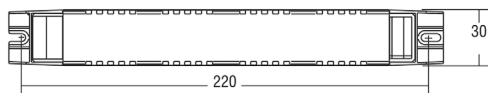

MP80/700SLI



Ref.	Tensão Tensión	Corrente Corriente (Intervalo 25mA)	Potência Potencia
20122213	30-160V	325-500mA	52-80W
	30-152V	525mA	80W
	30-145V	550mA	80W
	30-139V	575mA	80W
	30-133V	600mA	80W
	30-128V	625mA	80W
	30-123V	650mA	80W
	30-118V	675mA	80W
	30-114V	700mA	80W

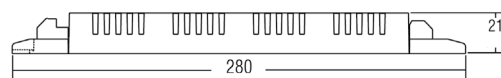
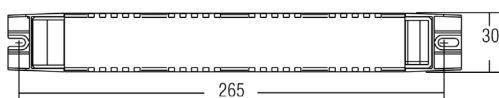

DRIVER LINEAR MULTI-CORRENTE IP20

DRIVER LINEAL MULTICORRIENTE



MP80/1400SV



AL

Ref.	Tensão Tensión	Corrente Corriente (Intervalo 50mA)	Potência Potencia
20127568	20-56V	350-1400mA	19,5-78W



MPX120 700SLIM



PL

Ref.	Tensão Tensión	Corrente Corriente (Intervalo 25mA)	Potência Potencia
20127172	60-243V	325-475mA	79-115W
	60-242V	500mA	120W
	60-229V	525mA	120W
	60-219V	550mA	120W
	60-209V	575mA	120W
	60-200V	600mA	120W
	60-192V	625mA	120W
	60-185V	650mA	120W
	60-178V	675mA	120W
	60-172V	700mA	120W

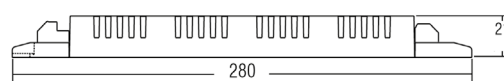
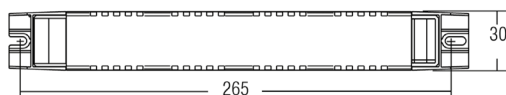

NOTA:

Outros modelos disponíveis por consulta.

Otros modelos disponibles bajo pedido.

DRIVER LINEAR MULTI-CORRENTE IP20
DRIVER LINEAL MULTICORRIENTE



MPX165 800SLI



Ref.	Tensão Tensión	Corrente Corriente (Intervalo 25mA)	Potência Potencia
20127678	60-244V	425-575mA	102-140W
	60-242V	600mA	145W
	60-241V	625-675mA	150-162W
	60-236V	700mA	165W
	60-228V	725mA	165W
	60-221V	750mA	165W
	60-213V	775mA	165W
	60-207V	800mA	165W

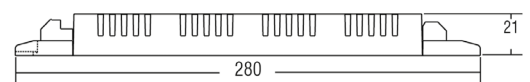
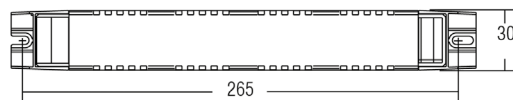

ATON 30



Ref.	Tensão Tensión	Corrente Corriente (Intervalo 30mA)	Potência Potencia
20151370BI	20-52V	250mA	13W
	15-52V	280mA	15W
	10-52V	310mA	16W
	3-52V	340-490mA	18-26W
	3-50V	520-610mA	26-30W
	3-46V	640mA	30W
	3-45V	670mA	30W
	3-43V	700mA	30W

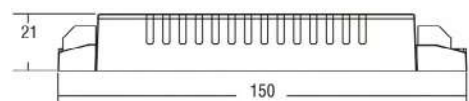
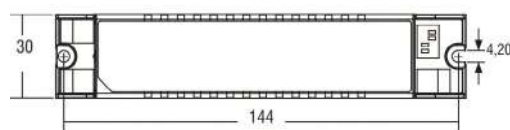

NOTA: Outros modelos disponíveis por consulta. Otros modelos disponibles bajo pedido.

DRIVER LINEAR MULTI-CORRENTE IP20

DRIVER LINEAL MULTICORRIENTE



ATON 30



Ref.	Tensão Tensión	Corrente Corriente (Intervalo 30mA)	Potência Potencia
20127360BI	20-54V	250mA	13W
	15-54V	280mA	15W
	10-54V	310mA	16,5W
	2-54V	340-490mA	18-26W
	2-50V	520-610mA	27,5-30W
	2-46V	640mA	30W
	2-45V	670mA	30W
	2-43V	700mA	30W

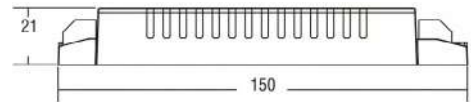
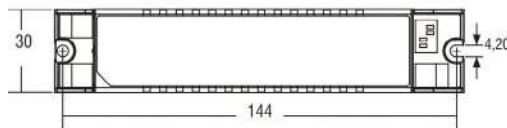

DRIVER LINEAR MULTI-CORRENTE IP20

DRIVER LINEAL MULTICORRIENTE



FMS NFC



Ref.	Tensão Tensión	Corrente Corriente	Potência Potencia
202871.8352	50-220V	80-350mA	35W
202871.8353	50-220V	120-600mA	75W
202871.4750	64-300V	200-700mA	100W

35W / 75W

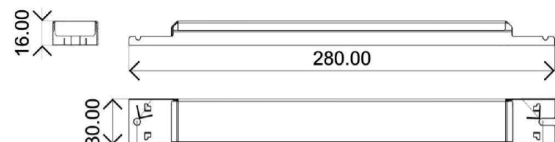

100W

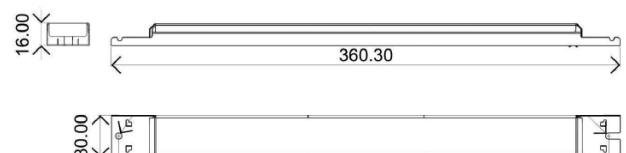



DRIVERS DIMÁVEIS

Drivers Regulables

DRIVER CC DIMÁVEL TRIAC PCD IP42

DRIVER CC REGULABLE TRIAC PCD

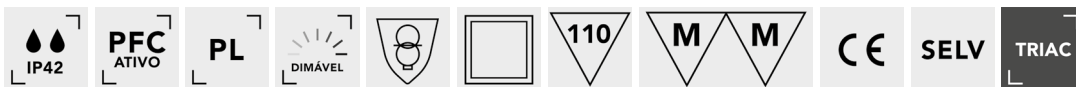

Ref.	Tensão Tensión	Corrente Corriente	Potência Potencia
202293.151	24-48V	350mA	16,8W

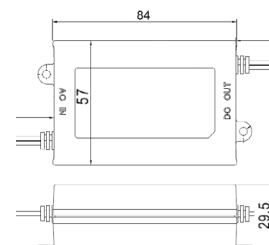

Ref.	Tensão Tensión	Corrente Corriente	Potência Potencia
202293.142*	40-58V	350mA	20,3W
202293.262	24-36V	700mA	25,2W

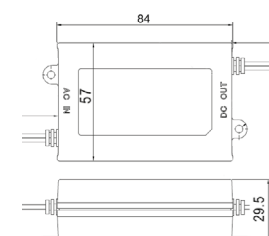

_*Ideal para dimar painéis de 15W a 18W

_*Ideal para paneles de 15W a 18W



Ref.	Tensão Tensión	Corrente Corriente	Potência Potencia
202293.241	70-108V	350mA	37,8W
202293.85	45-80V	500mA	40W
202293.62*1	34-57V	700mA	40W
202293.132*2	22-38V	1050mA	40W

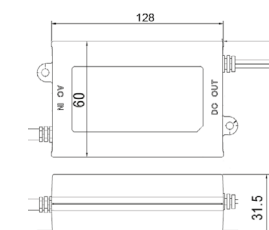

_*1Ideal para dimar painéis 60x60, 40W | Ideal para paneles de 60x60, 40W

_*2Ideal para dimar painéis 60x60, 48W | Ideal para paneles de 60x60, 48W



Ref.	Tensão Tensión	Corrente Corriente	Potência Potencia
202293.245	70-108V	500mA	54W
202293.212	50-86V	700mA	60,2W
202293.253*	34-57V	1050mA	59,8W
202293.6115	24-43V	1400mA	60,2W

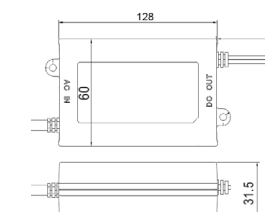

_*Ideal para dimar painéis 60x60, 48W | Ideal para paneles de 60x60, 48W

DRIVER CC DIMÁVEL TRIAC IP20

DRIVER CC REGULABLE TRIAC

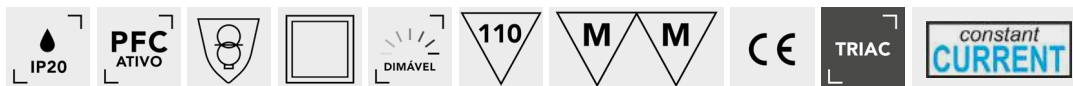

MINI MD



Ref.	Tensão Tensión	Corrente Corriente	Potência Potencia
20127037	25-50V	250mA	12,5W
20127031	25-51V	350mA	18W
20127033	16-42V	500mA	20W
20127447	16-28V	700mA	20W

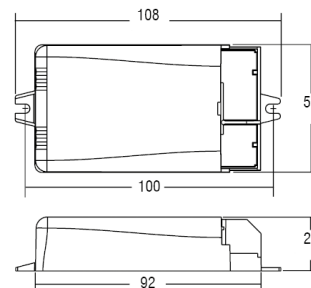

MICRO MD



Ref.	Tensão Tensión	Corrente Corriente	Potência Potencia
20127041	12-28V	350mA	10W
20127042	6-20V	500mA	10W
20127047	6-14V	700mA	10W

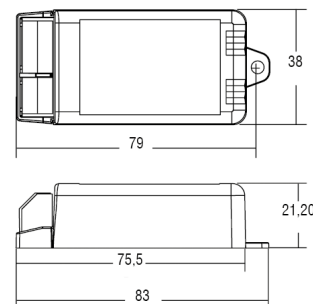

BMU MD CC



Ref.	Tensão Tensión	Corrente Corriente	Potência Potencia
20127390	12-28V	350mA	10W
20127392	10-20V	500mA	10W
20127394	6-14V	700mA	10W

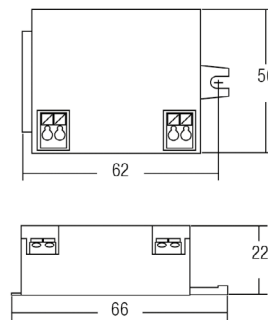

DRIVER CC MULTI-CORRENTE DIMÁVEL TRIAC IP20

DRIVER CC MULTICORRIENTE REGULABLE TRIAC



MINI JOLLY MD 20



Ref.	Tensão Tensión	Corrente Corriente	Potência Potencia
20127557	15-48V	250mA	12W
	15-48V	300mA	14W
	10-48V	350mA	17W
	5-48V	400mA	19W
	5-44V	450mA	20W
	5-40V	500mA	20W
	5-36V	550mA	20W
	5-33V	600mA	20W
	5-31V	650mA	20W
	5-29V	700mA	20W
	5-27V	750mA	20W
	5-25V	800mA	20W
	5-23V	850mA	20W
	5-22V	900mA	20W
	CV	12V	900mA
	24V	830mA	20W

constant
VOLTAGE

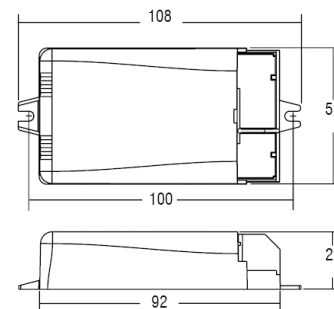

PUMA MD 20MD 20



Ref.	Tensão Tensión	Corrente Corriente (Intervalo 50mA)	Potência Potencia
20127102	7-44V	150-450mA	6-19W
	7-40V	500mA	20W
	7-36V	550mA	20W
	7-33V	600mA	20W
	7-30V	650mA	20W
	7-28V	700mA	20W

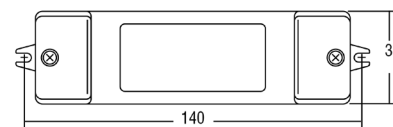
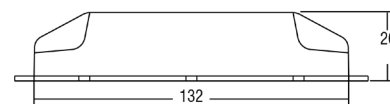

JOLLY MD



Ref.	Tensão Tensión	Corrente Corriente	Potência Potencia
20122260	2-47V	350mA	17W
	2-47V	500mA	24W
	2-47V	550mA	25W
	2-46V	700mA	32W
	2-43V	750mA	32W
CV	12V	900mA	10W
	24V	900mA	20W

constant
VOLTAGE

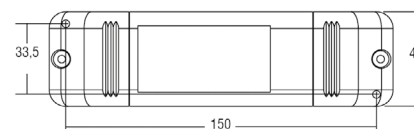
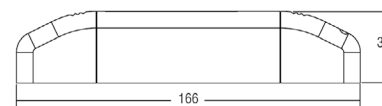

DRIVER CC MULTI-CORRENTE DIMÁVEL TRIAC

DRIVER CC MULTICORRIENTE REGULABLE TRIAC

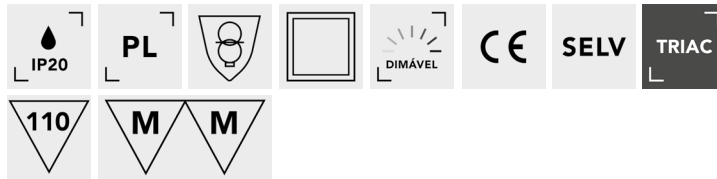

Ref.	Tensão Tensión	Corrente Corriente (Intervalo 50mA)	Potência Potencia
2018851.8146	3-42V	100-200mA	4,2-8,4W
	3-40V	250mA	10W
	3-33V	300mA	10W
	3-28V	350mA	10W
	3-25V	400mA	10W
	3-22V	450mA	10W

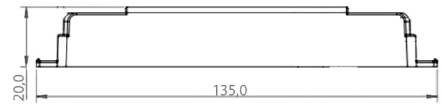
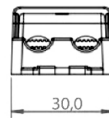

Ref.	Tensão Tensión	Corrente Corriente (Intervalo 50mA)	Potência Potencia
2018851.8147	3-42V	300-450mA	10,5-18,9W
	3-40V	500mA	20W
	3-36V	550mA	19,8W
	3-33V	600mA	19,8W
	3-29V	700mA	20,3W

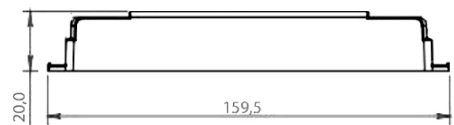
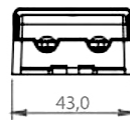

NOTA: Outros modelos disponíveis por consulta. Otros modelos disponibles bajo pedido.



DRIVER CC MULTI-CORRENTE DIMÁVEL TRIAC

DRIVER CC MULTICORRIENTE REGULABLE TRIAC

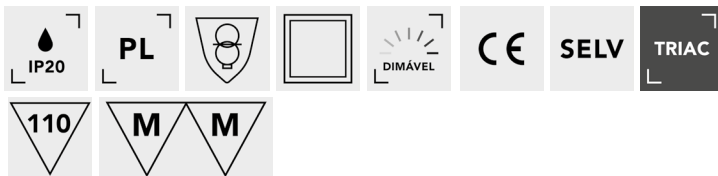

Ref.	Tensão Tensión	Corrente Corriente (Intervalo 50mA)	Potência Potencia
2018851.8248	3-65V	300-600mA	19,5-39W
	3-62V	650mA	40W
	3-57V	700mA	40W
	3-50V	800mA	40W
	3-45V	900mA	40W
	3-40V	1000mA	40W
	3-37V	1100mA	40W
	3-34V	1200mA	40W
	3-31V	1300mA	40W
	3-29V	1400mA	40W

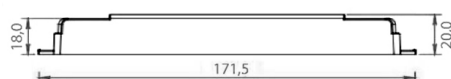
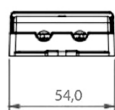

Ref.	Tensão Tensión	Corrente Corriente (Intervalo 100mA)	Potência Potencia
2018851.8249	3-65V	600-900mA	39-58,5W
	3-60V	1000mA	60W
	3-54V	1100mA	60W
	3-50V	1200mA	60W
	3-46V	1300mA	60W
	3-43V	1400mA	60W
	3-40V	1500mA	60W
	3-38V	1600mA	60W
	3-35V	1700mA	60W
	3-33V	1800mA	60W
	3-32V	1900mA	60W
	3-30V	2000mA	60W
	3-29V	2100mA	60W

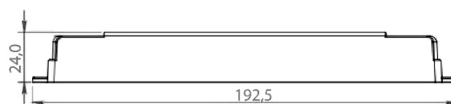
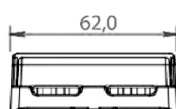

DRIVER CC MULTI-CORRENTE DIMÁVEL 0/1-10V XLG IP67
DRIVER CC MULTICORRIENTE REGULABLE 0/1-10V XLG

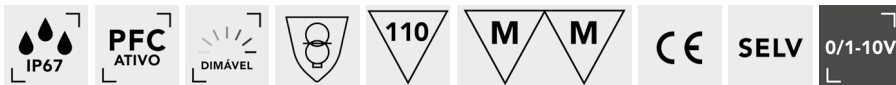

XLN



Ref.	Tensão Tensión	Corrente Corriente	Potência Potencia
2028966.952	9-54Vd	700mA	25W

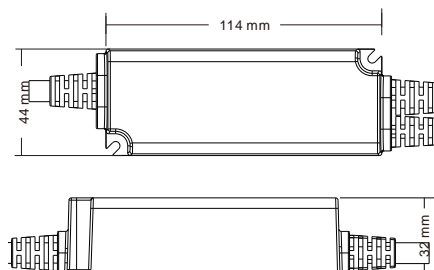

XLG-25 E XLG-50



Ref.	Tensão Tensión	Corrente Corriente	Potência Potencia
202535.443	22-54V	250-1050mA	25W
202535.4426	22-54V	530-2100mA	50W

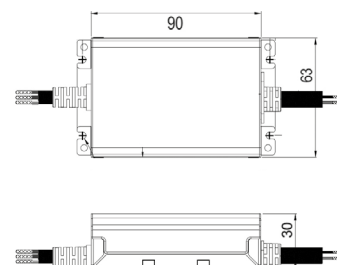

XLG-75



Ref.	Tensão Tensión	Corrente Corriente	Potência Potencia
2015535.4814	53-107V	350-1050mA	75W
202535.5242	27-56V	650-2100mA	75W

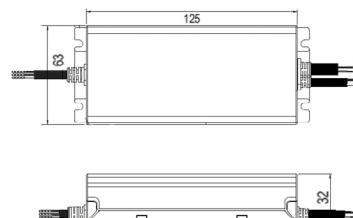

XLG-100



Ref.	Tensão Tensión	Corrente Corriente	Potência Potencia
201535.6114	71-142V	350-1050mA	100W
201535.527	27-56V	875-2780mA	100W

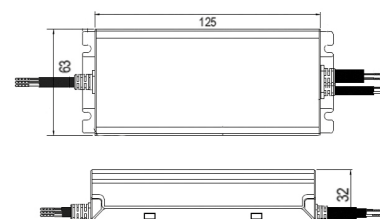

XLG-150



Ref.	Tensão Tensión	Corrente Corriente	Potência Potencia
202535.6614	120-214V	350-1050mA	150W
202535.7845	60-107V	700-2100mA	150W
202535.5243	27-56V	1400-4170mA	150W

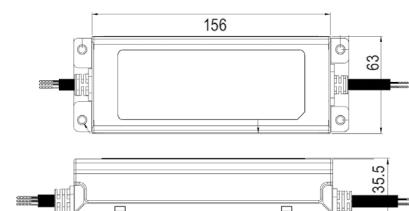

DRIVER CC MULTI-CORRENTE DIMÁVEL 0/1-10V XLG IP67

DRIVER CC MULTICORRIENTE REGULABLE 0/1-10V XLG

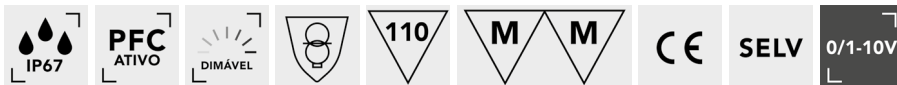

XLG-200



Ref.	Tensão Tensión	Corrente Corriente	Potência Potencia
202536.3414	142-285V	350-1050mA	200W
202536.5234	27-56V	1750-5550mA	200W

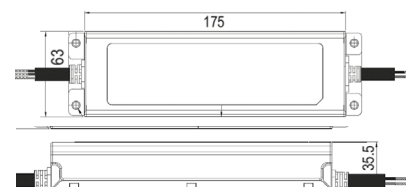

XLG-200-DA2



Ref.	Tensão Tensión	Corrente Corriente	Potência Potencia
2019536.3441	142-285Vdc	700-1050mA	200W

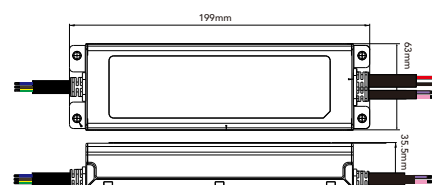

XLG-240



Ref.	Tensão Tensión	Corrente Corriente	Potência Potencia
202536.6414	178-342V	350-1050mA	240W
202535.7945	90-171V	700-2100mA	240W
202535.5244	27-56V	2400-6660mA	240W

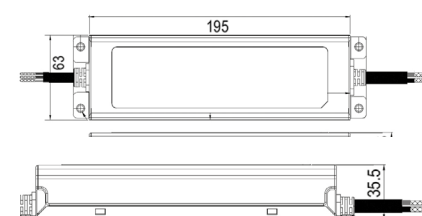

DRIVER CC MULTI-CORRENTE DIMÁVEL DALI XLG IP67

DRIVER CC MULTICORRIENTE REGULABLE DALI XLG



XLG-240-DA2



Ref.	Tensão Tensión	Corrente Corriente	Potência Potencia
2019535.4155	27-56V	4280-6660mA	240W

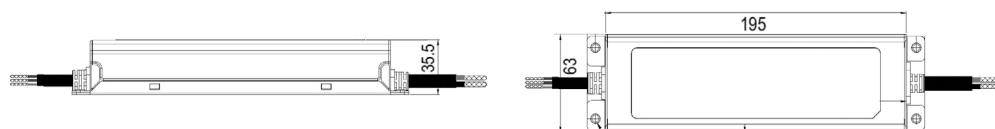



DRIVER CC MULTI-CORRENTE DIMÁVEL LCM

DRIVER CC MULTICORRIENTE REGULABLE LCM

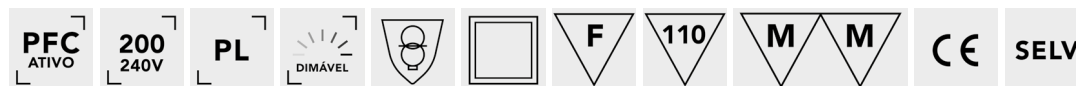

Ref.	Potência Potencia	Corrente Corriente	Tensão Tensión
209191.25	25W	350mA	6-54V
		500mA	6-50V
202191.25	25W	600mA	6-42V
		700mA	6-36V
		1050mA	6-24V

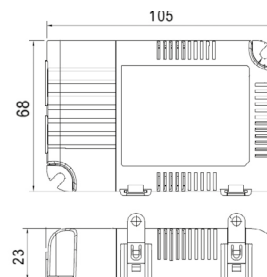

Ref.	Potência Potencia	Corrente Corriente	Tensão Tensión
209191.40	40W	350mA	2-100V
		500mA	2-80V
202191.40	40W	600mA	2-67V
		700mA	2-57V
		1050mA	2-40V

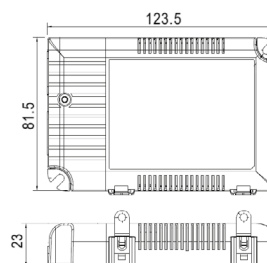

Ref.	Potência Potencia	Corrente Corriente	Tensão Tensión
209191.60	60W	500mA	2-90V
		600mA	2-90V
		700mA	2-86V
202191.60	60W	900mA	2-67V
		1050mA	2-57V
		1400mA	2-42V

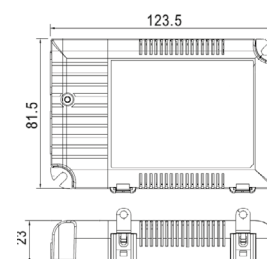

DRIVER CC MULTI-CORRENTE DIMÁVEL IP20

DRIVER CC MULTICORRIENTE REGULABLE



Ref.	Tensão Tensión	Corrente Corriente	Potência Potencia
2012521.4322	6-42V	200mA	8.4W
	6-40V	250mA	10W
	6-33V	300mA	9.9W
	6-28V	350mA	9.8W

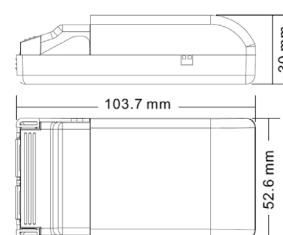

DRIVER DIMÁVEL 0/1-10V E PUSH IP20
DRIVER REGULABLE 0/1-10V Y PUSH



MICRO JOLLY 6 Mini



Ref.	Tensão Tensión	Corrente Corriente	Potência Potencia
20122426	2-18V	350mA	6W

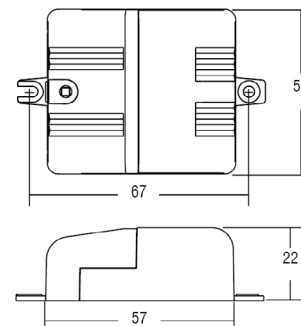

RD57 CC CIRCULAR



Ref.	Tensão Tensión	Corrente Corriente	Potência Potencia
20127342	2.85-24V	350mA	9W
20127344	1.43-12V	700mA	9W

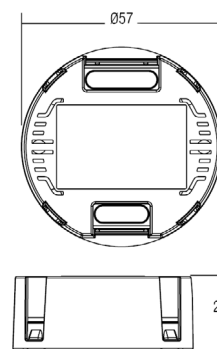

DRIVER CC MULTI-CORRENTE DIMÁVEL 0/1-10V IP20
DRIVER CC MULTICORRIENTE REGULABLE 0/1-10V

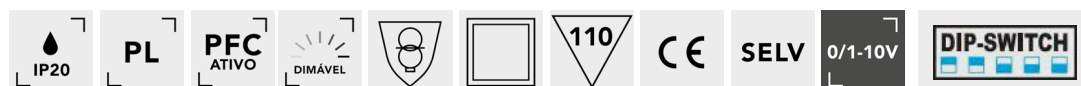

Jolly HC 39



Ref.	Tensão Tensión	Corrente Corriente (Intervalo 20mA)	Potência Potencia
20151401	20-54V	100-120mA	4,5-6,4W
	10-53V	140mA	7,5W
	2-53V	160-280mA	8,5-15W
	2-52,5V	300mA	16W
	2-52V	320-380mA	17-20W

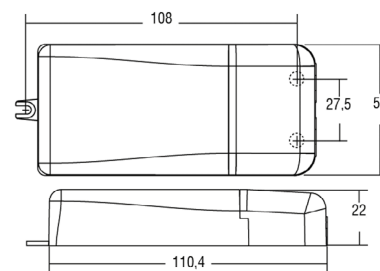

DRIVER CC MULTI-CORRENTE DIMÁVEL 0/1-10V IP20

DRIVER CC MULTICORRIENTE REGULABLE 0/1-10V

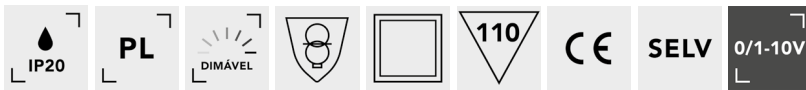

FLS



Ref.	Tensão Tensión	Corrente Corriente	Potência Potencia
209451.3317	12-40V	120mA	4,8W
	12-40V	150mA	6W
	12-40V	200mA	8W
	12-40V	300mA	12W
	12-40V	350mA	12,1W

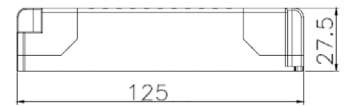

Ref.	Tensão Tensión	Corrente Corriente (Intervalo 50mA)	Potência Potencia
207411.2333	12-40V	400-700mA	16-20,3W

FLS



Ref.	Tensão Tensión	Corrente Corriente	Potência Potencia
207411.2433	12-45V	600mA	27W
	12-43V	700mA	30.1W
	12-37.5V	800mA	30W
	12-33.5V	900mA	30.2W

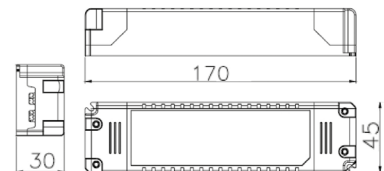

Ref.	Tensão Tensión	Corrente Corriente	Potência Potencia
207411.2533	12-45V	850mA	38,3W
	12-45V	900mA	40,1W
	12-45V	1000mA	40W
	12-45V	1050mA	40,4W

NOTA Todas estas fontes são de corrente ajustável por switch. Todas estas fuentes son ajustables por interruptor de corriente.

DRIVER MULTI-CORRENTE DIMÁVEL 0/1-10V E PUSH IP20

DRIVER MULTICORRIENTE REGULABLE 0/1-10V Y PUSH



Maxi Jolly



Ref.	Tensão Tensión	Corrente Corriente (Intervalo 50mA)	Potência Potencia
20151414	20-112V	250-450mA	28-50W
	2-112V	500mA	56W
	2-110V	550mA	60W
	2-100V	600mA	60W
	2-92Vd	650mA	60W
	2-86V	700mA	60W

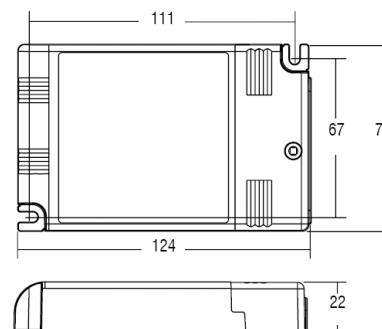

Maxi Jolly 20



Ref.	Tensão Tensión	Corrente Corriente	Potência Potencia	
20151400	20-53V	250mA	13W	
	20-52V	300mA	15W	
	15-50V	350mA	18W	
	15-50V	400mA	20W	
	5-45V	450mA	20W	
	5-40V	500mA	20W	
	3-37V	550mA	20W	
	20125400	3-34V	600mA	20W
		3-31V	650mA	20W
		3-29V	700mA	20W
3-27V		750mA	20W	
3-25V		800mA	20W	
3-24V		850mA	20W	
3-23V		900mA	20W	
CV		12V	900mA	11W
		24V	900mA	20W

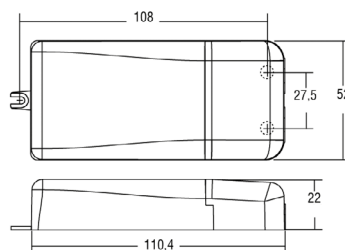

NOTA: Outros modelos disponíveis por consulta. Outros modelos disponíveis por consulta.

DRIVER MULTI-CORRENTE DIMÁVEL 0/1-10V E PUSH IP20

DRIVER MULTICORRIENTE REGULABLE 0/1-10V Y PUSH

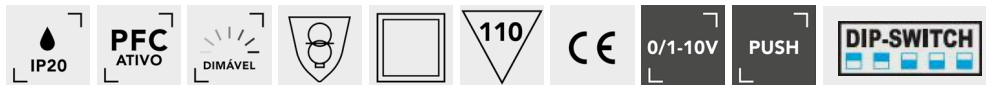

Maxi Jolly US60



Ref.	Tensão Tensión	Corrente Corriente	Potência Potencia
20127411	2-74V	350mA	25W
	2-72V	500mA	35W
	2-72V	550mA	39W
	2-72V	650mA	46W
	2-72V	700mA	50W
	2-72V	750mA	54W
	2-70V	850mA	60W
	2-66V	900mA	60W
	2-60V	1000mA	60W
	2-57V	1050mA	60W

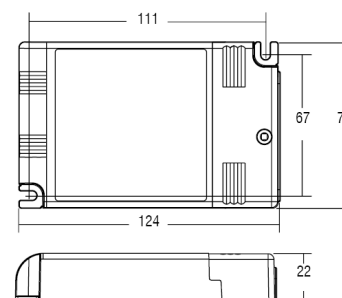

Maxi Jolly SV50



Ref.	Tensão Tensión	Corrente Corriente (Intervalo 50mA)	Potência Potencia
20125502	10-53V	350-900mA	18.5-47.5W
	10-52V	950mA	50W
	10-50V	1000mA	50W
	10-48V	1050mA	50W
	10-45V	1100mA	50W
	10-43V	1150mA	50W
	10-41V	1200mA	50W

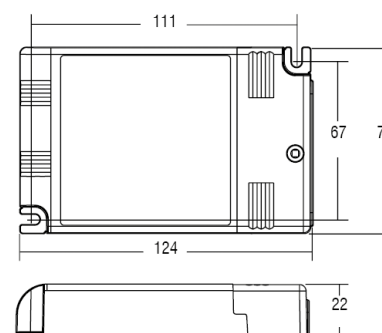

DRIVER MULTI-CORRENTE DIMÁVEL DALI NFC

DRIVER MULTICORRIENTE REGULABLE DALI NFC



Ref.	Tensão Tensión	Corrente Corriente	Potência Potencia
2019901.8154	3-42V	100-500mA	10W

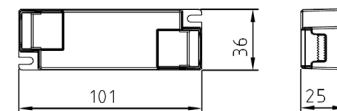

Ref.	Tensão Tensión	Corrente Corriente	Potência Potencia
2019901.434	6-58V	250-700mA	25W

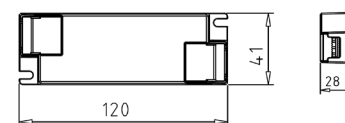

DRIVER MULTI-CORRENTE DIMÁVEL DALI IP20

DRIVER MULTICORRIENTE REGULABLE DALI

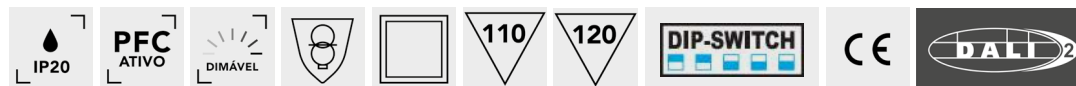

Mini Jolly OS60



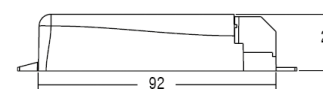
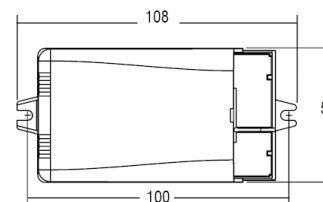
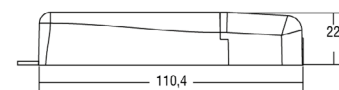
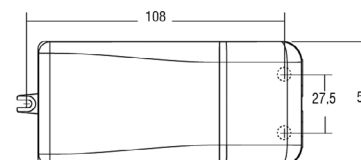

Ref.	Tensão Tensión	Corrente Corriente	Potência Potencia
20125403	15-49V	250mA	12W
	10-49V	350mA	17W
20151403	5-49V	400mA	19W
20125403BI	5-45V	450mA	20W
	5-40V	500mA	20W
	3-36V	550mA	20W
CV	3-33V	600mA	20W
	3-28V	700mA	20W
	24V	700mA	16W

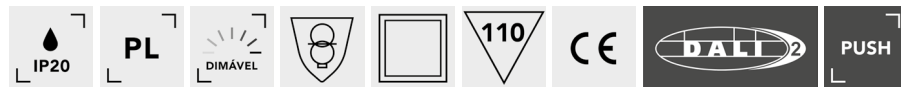

DRIVER CC MULTI-CORRENTE DIMÁVEL DALI2 PUSH IP20

DRIVER CC MULTICORRIENTE REGULABLE DALI2 PUSH

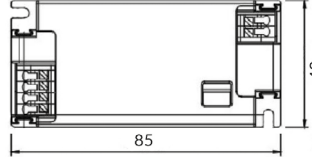
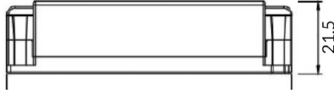

DALI2 LD	Ref.	Tensão Tensión	Corrente Corriente	Potência Potencia	
	2018411.7617	9-42V	120mA	5,04W	
		9-42V	150mA	6,3W	
		9-42V	180mA	7,56W	
		9-42V	200mA	8,4W	
		9-42V	250mA	10,5W	
		9-42V	280mA	11,76W	
		9-42V	300mA	12,6W	
		9-42V	350mA	14,7W	

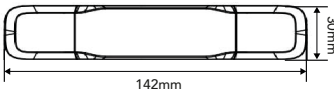
DALI2 LD	Ref.	Tensão Tensión	Corrente Corriente	Potência Potencia	
	202401.9617	5-42V	120-350mA	8W	



DALI2 LD-ADV	Ref.	Tensão Tensión	Corrente Corriente	Potência Potencia	
	2019451.8957	2.5-52V	150mA	7,8W	
		2.5-52V	200mA	10,4W	
		2.5-52V	250mA	13W	
		2.5-52V	300mA	15,6W	
		2.5-52V	350mA	18,2W	
		2.5-52V	400mA	20,8W	
		2.5-52V	500mA	26W	
		2.5-52V	600mA	31,2W	
		2.5-52V	700mA	36,4W	
		2.5-52V	750mA	39W	
		2.5-52V	800mA	41,6W	
		2.5-49V	850mA	41,65W	
		2.5-46V	900mA	41,4W	
		2.5-44V	950mA	41,8W	
		2.5-42V	1000mA	42W	
		2.5-40V	1050mA	42W	

DRIVER CC MULTI-CORRENTE DIMÁVEL DALI2 PUSH CCPD2 IP20

DRIVER CC MULTICORRIENTE REGULABLE DALI2 PUSH CCPD2



CCPD2



Ref.	Tensão Tensión	Corrente Corriente	Potência Potencia
206851.814	3-42Vcc	250mA	10,5W
	3-42Vcc	350mA	14,7W
	3-42Vcc	400mA	16,8W
	3-42Vcc	450mA	18,9W
	3-40Vcc	500mA	20W
	3-36Vcc	550mA	19,8W
	3-33Vcc	600mA	19,8W
	3-29Vcc	700mA	20,3W

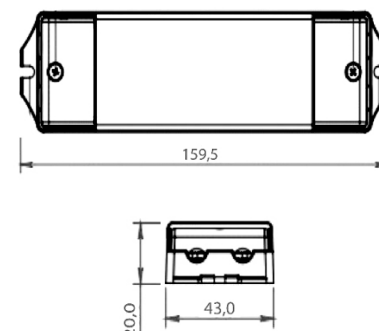

CCPD2



Ref.	Tensão Tensión	Corrente Corriente (Intervalo 50mA)	Potência Potencia
206851.4882	3-65V	300-600mA	10,5W
	3-62V	650mA	40W
	3-57V	700mA	40W
	3-50V	800mA	40W
	3-45V	900mA	40W
	3-40V	1000mA	40W
	3-37V	1100mA	40W
	3-34V	1200mA	40W
	3-31V	1300mA	40W
	3-29V	1400mA	40W

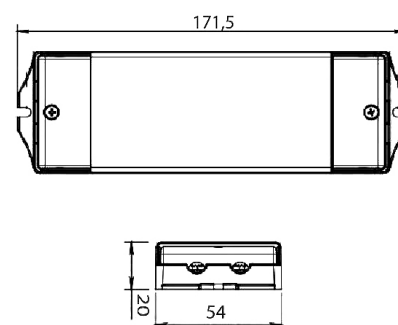

CCPD2



Ref.	Tensão Tensión	Corrente Corriente (Intervalo 50mA)	Potência Potencia
202841.596	3-42V	100-200mA	4.2-8.4W
	3-40V	250mA	10W
	3-33V	300mA	10W
	3-29V	350mA	10W
	3-25V	400mA	10W
	3-22V	450mA	10W

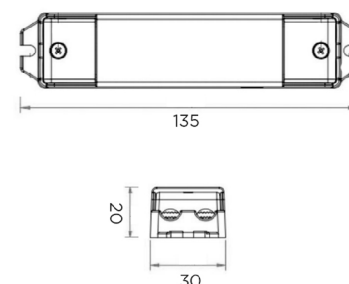

DRIVER MULTI-CORRENTE DIMÁVEL 0/1-10V, DALI2 E PUSH

DRIVER MULTICORRIENTE REGULABLE 0/1-10V, DALI2 Y PUSH

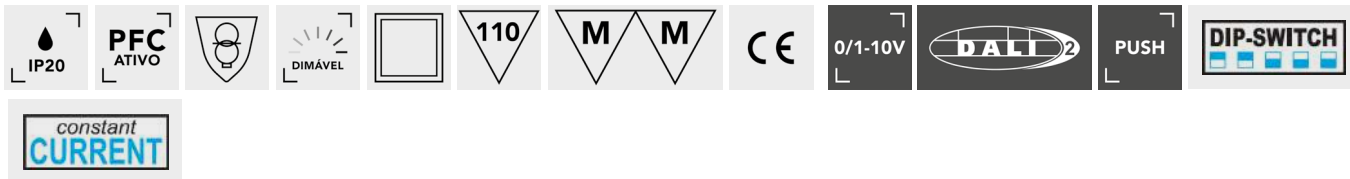

Maxi Jolly



Ref.	Tensão Tensión	Corrente Corriente (Intervalo 50mA)	Potência Potencia
20125506	10-53V	350-750mA	18,5-39,5W
	10-50V	800mA	40W
	10-47V	850mA	40W
	10-44V	900mA	40W
	10-42V	950mA	40W
	10-40V	1000mA	40W
	10-38V	1050mA	40W
	10-36V	1100mA	40W
	10-35V	1150-1200mA	40W

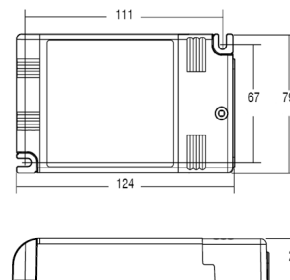

Maxi Jolly HV Dali



Ref.	Tensão Tensión	Corrente Corriente (Intervalo 50mA)	Potência Potencia
20151409	20-112V	250-450mA	28-50W
	2-112V	500mA	56W
	2-110V	550mA	60W
	2-100V	600mA	60W
	2-92V	650mA	60W
	2-86V	700mA	60W

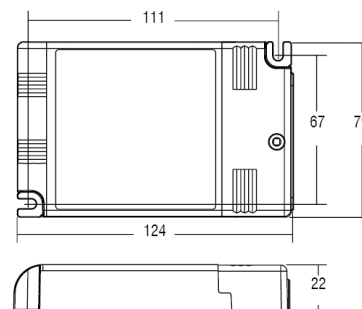

DRIVER MULTI-CORRENTE DIMÁVEL DALI2 E PUSH

DRIVER MULTICORRIENTE REGULABLE DALI2 Y PUSH



Maxi Jolly US Dali 60



Ref.	Tensão Tensión	Corrente Corriente	Potência Potencia
20151413	2-74V	350mA	25W
	2-72V	500mA	35W
	2-72V	550mA	39W
	2-72V	650mA	46W
	2-72V	700mA	50W
20127413	2-72V	750mA	54W
	2-70V	850mA	60W
	2-66V	900mA	60W
	2-60V	1000mA	60W
	2-57V	1050mA	60W

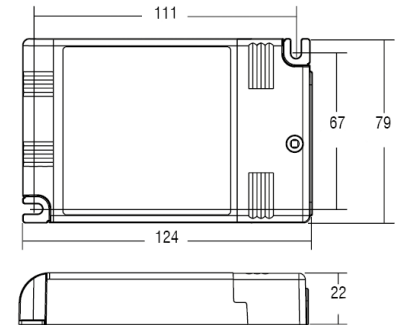

Pro Flat Dali 26



Ref.	Tensão Tensión	Corrente Corriente (Intervalo 30mA)	Potência Potencia
20127576	10-49V	250-310mA	11.5-14.5W
	10-48V	340-370mA	15.5-16.7W
	10-47V	400-460mA	18-20.5W
	10-46V	490-520mA	21.5-22.8W
	10-45V	550mA	23.7W
	10-44V	580-610mA	24.5-25.7W
	10-41V	640mA	26W
	10-39V	670mA	26W
	10-37V	700mA	26W

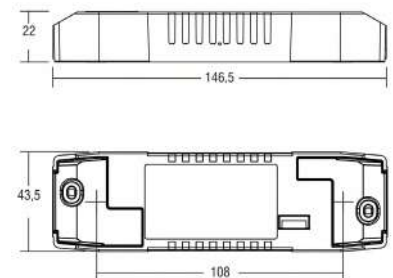

NOTA: Outros modelos disponíveis por consulta. Otros modelos disponibles bajo pedido.

DRIVER MULTI-CORRENTE DIMÁVEL DALI2 E PUSH

DRIVER MULTICORRIENTE REGULABLE DALI2 Y PUSH

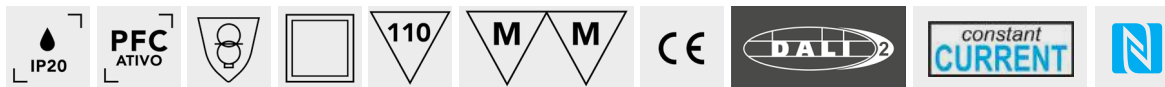

Professionale 20 DALI NFC



Ref.	Tensão Tensión	Corrente Corriente	Potência Potencia
20142011	10-54V	125-500mA	1-20W

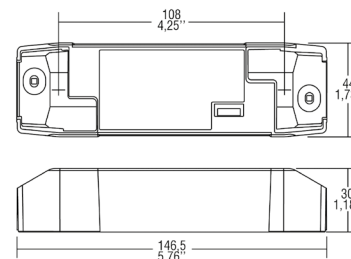

Professionale 20 DALI NFC BI



Ref.	Tensão Tensión	Corrente Corriente	Potência Potencia
20142013	10-54V	125-500mA	1-20W

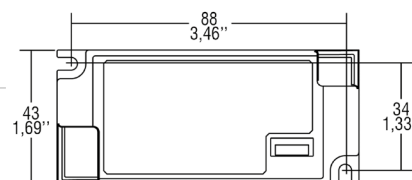

Professionale DALI NFC 38



Ref.	Tensão Tensión	Corrente Corriente	Potência Potencia
20142010	10-54V	300-1050mA	3-38W

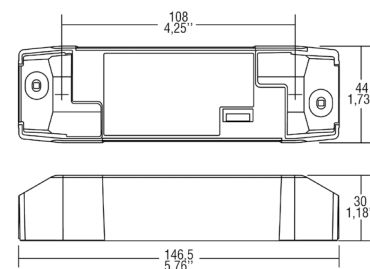

NOTA: Outros modelos disponíveis por consulta. Otros modelos disponibles bajo pedido.

DRIVER LINEAR MULTI-CORRENTE DIMÁVEL 0/1-10V PUSH

DRIVER LINEAL MULTICORRIENTE REGULABLE 0/1-10V PUSH



Jolly Slim 32



Ref.	Tensão Tensión	Corrente Corriente (Intervalo 50mA)	Potência Potencia
20123680	2-53V	250-350mA	13-18W
	2-52V	400-550mA	21-28W
	2-51V	600mA	30W
	2-46V	700mA	32W
constant VOLTAGE	CV 24V	700mA	17W

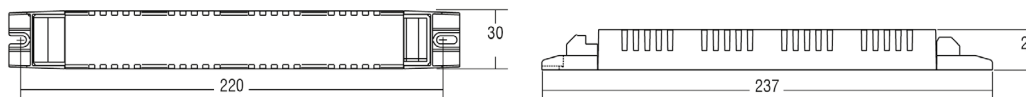

T-LED 80/350



Ref.	Tensão Tensión	Corrente Corriente (Intervalo 15mA)	Potência Potencia
20127080	30-250V	140-320mA	35-80W
	30-235V	335mA	80W
	30-228V	350mA	80W

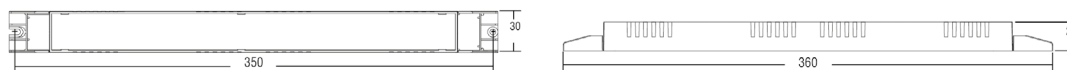

T-LED 80/500



Ref.	Tensão Tensión	Corrente Corriente (Intervalo 20mA)	Potência Potencia
20127081	30-170V	220-460mA	37.4-78.2W
	30-167V	480mA	80W
	30-160V	500mA	80W

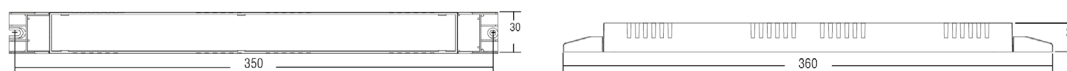

T-LED 80/700



Ref.	Tensão Tensión	Corrente Corriente (Intervalo 25mA)	Potência Potencia
20127082	30-120V	350-650mA	42-78W
	30-118V	675mA	80W
	30-114V	700mA	80W



DRIVER LINEAR MULTI-CORRENTE DIMÁVEL DALI2 E PUSH DRIVER LINEAL MULTICORRIENTE REGULABLE DALI2 Y PUSH



FMS Dali 2



Ref.	Tensão Tensión	Corrente Corriente	Potência Potencia
2019871.8352	50-220V	80-350mA	35W
2019871.8353	50-220V	120-600mA	75W
2019871.4750	50-220V	300-1050mA	100W
2019871.4751	50-220V	300-6500mA	150W
	50-150V	950-1000mA	
	50-142V	1001-1050mA	



DRIVER LINEAR MULTI-CORRENTE DIMÁVEL DALI E PUSH DRIVER LINEAL MULTICORRIENTE REGULABLE DALI Y PUSH



T-LED 80-350 DALI Slim



Ref.	Tensão Tensión	Corrente Corriente (Intervalo 15mA)	Potência Potencia
20127091	30-250V	140-320mA	35-80W
	30-235V	335mA	80W
	30-228V	350mA	80W

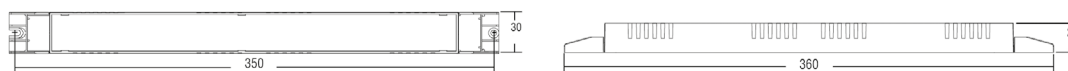

T-LED 80-700 DALI Slim



Ref.	Tensão Tensión	Corrente Corriente (Intervalo 25mA)	Potência Potencia
20127087	30-120V	350-650mA	42-78W
	30-118V	675mA	80W
	30-114V	700mA	80W

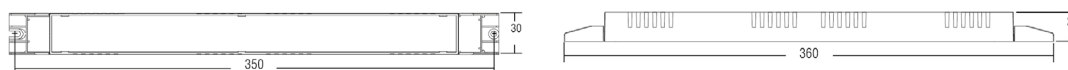

NOTA: Outros modelos disponíveis por consulta. Otros modelos disponibles bajo pedido.

DRIVER LINEAR MULTI-CORRENTE DIMÁVEL DALI2 E PUSH DRIVER LINEAL MULTICORRIENTE REGULABLE DALI2 E PUSH



ATON 30D



Ref.	Tensão Tensión	Corrente Corriente (Intervalo 30mA)	Potência Potencia
20151370	20-52V	250mA	13W
	15-52V	280mA	15W
	10-52V	310mA	16W
	3-52V	340-490mA	18-26W
	3-50V	520-610mA	26-30W
	3-46V	640mA	30W
	3-45V	670mA	30W
	3-43V	700mA	30W



S-LED DALI SLIM



Ref.	Tensão Tensión	Corrente Corriente	Potência Potencia
20127613	100-300V	150-500mA	28-100W

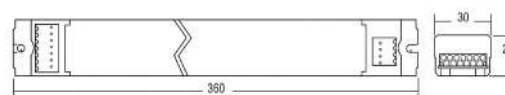

NOTA: Outros modelos disponíveis por consulta. Otros modelos disponibles bajo pedido.



CASAMBI MESH 2.4G  zigbee



matter



SMART LIFE
Smart Living



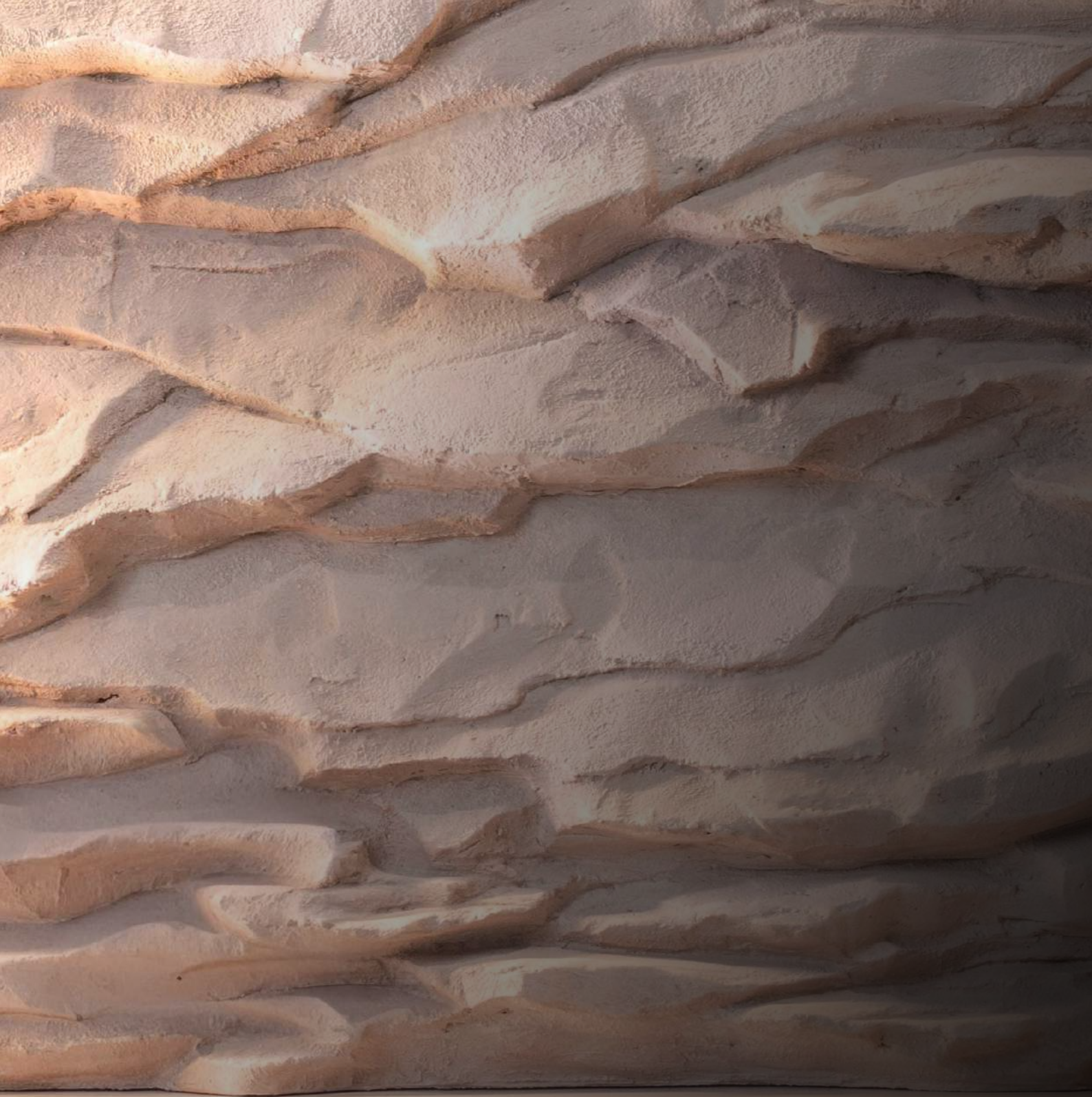

SMART HOME

Casa Inteligente



CONTROLLO RF

Control RF



CONTROLADOR DIMMER
CONTROLADOR REGULABLE

230V LED 240W PL CE PUSH



REF. 20180426 **Controlador Dimmer Push 230V**
Controlador Regulable Push 230V

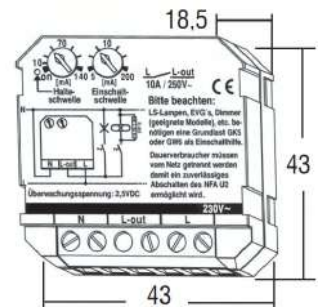

230V HALOG. 400W LED 200W PL RF 1 CANAL CE PUSH



REF. 211218.3400 **Controlador Dimmer Push 230V**
Controlador Regulable Push 230V
_Controlador ideal para todos os equipamentos de 240V com driver dimável. Poderá ser aplicado na caixa de aparelhagem de fundo duplo, possibilitando assim o seu modo de funcionamento push.

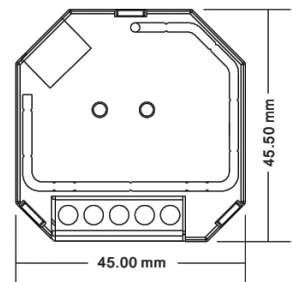

_Controlador ideal para todos los equipos de 240V con Drivers Regulables. Se puede aplicar a una caja de distribución de doble fondo, habilitando así su modo de funcionamiento push.

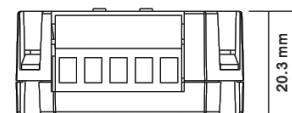

12-48 VDC 150W PL 1 CANAL CE PUSH NOVO



REF. 2116224.6150 **Controlador Dimmer Push 12-48Vdc Dalcnet**
Controlador Regulable Push 12-48Vdc Dalcnet
_Controlador regulável por botão, interruptor, 0/1-10V ou potenciômetro.
_Controlador regulable por pulsador, interruptor, 0/1-10V o potenciómetro.

12-36 VDC PL RF 1 CANAL 8A CANAL CE PUSH



REF. 211218.196 **Controlador Dimmer Cor Simples 1 canal**
Controlador Regulable Color Simple 1 canal

_Ideal para controlar fitas led de 12Vdc e 24Vdc, até uma potência máxima de 96W (12Vdc) e 192W (24Vdc). Este permite ser controlado por rádiofrequência e push.

_Ideal para controlar tiras led de 12Vdc y 24Vdc, hasta una potencia máxima de 96W (12Vdc) y 192W (24Vdc). Este permite ser controlado por radiofrecuencia y pulsador.

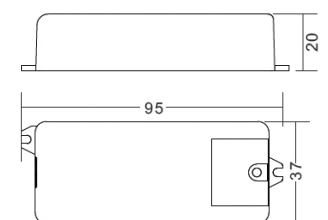

COMANDO RECOMENDADO
MANDO RECOMENDADO



REF. 213219.DIM4 **Comando RF 4 canais; Control Cor Simples; Comanda 4 controladores.**
Mando RF 4 canales; Control Color simple; Comanda 4 controladores.

NOTA:
Este comando é compatível com todos os nossos controladores da série 211218.xxxx.
Este mando es compatible con todos nuestros controladores de la serie 211218.xxxx

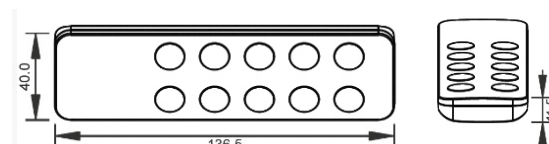

CONTROLADORES DIMMER
CONTROLADORES REGULABLES

12-36 VDC | PL | RF | 4 CANAIS | 5A CANAL | CE | PUSH



REF. 211218.1240

Controlador Dimmer 4 Canais, Push Dim / RF
Controlador Regulable 4 Canales, Push Dim / RF

_Controlador ideal para controlar fitas LED de 12Vdc e 24Vdc, até uma potência máxima de 240W (12Vdc) e 480W (24Vdc);
_Este permite ser controlado por rádiofrequência e push;
_Também podemos controlar os 4 canais em simultâneo ou em separado, esta situação depende da escolha do comando.

_Controlador ideal para controlar tiras LED de 12Vdc y 24Vdc, hasta una potencia máxima de 240W (12Vdc) y 480W (24Vdc);
_Este permite ser controlado por radiofrecuencia y pulsador;
_También podemos controlar los 4 canales simultáneamente por separado, esta situación depende de la elección de mando.

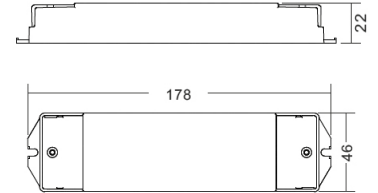

NOTA

_Controlo de 1 comando para 4 controladores.
Control de 1 mando para 4 controladores.
Ref. 213219.DIM4

_Controlo de 1 comando para 1 controlador com separação de 4 canais.
Control de 1 mando para 1 controlador con separación de 4 canales.
Ref. 213219.DIM1

12-36 VDC | PL | RF | 4 CANAIS | 8A CANAL | CE | PUSH



REF. 211218.1384

Controlador Dimmer Cor Simples 4 canais, Push Dim / RF
Controlador Regulable Color Simple 4 canales, Push Dim / RF

_Controlador ideal para controlar fitas LED de 12Vdc e 24Vdc, até uma potência máxima de 384W (12Vdc) e 768W (24Vdc);
_Este permite ser controlado por rádiofrequência e push;
_Também podemos controlar os 4 canais em simultâneo ou em separado, esta situação depende da escolha do comando.

_Controlador ideal para controlar tiras LED de 12Vdc y 24Vdc, hasta una potencia máxima de 384W (12Vdc) y 768W (24Vdc);
_Este permite ser controlado por radiofrecuencia y pulsador;
_También podemos controlar los 4 canales simultáneamente o por separado, esta situación depende de la elección de mando.

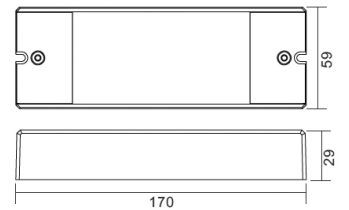

COMANDO RECOMENDADO
MANDO RECOMENDADO



REF. 213219.DIM1

_Comando RF 4 canais;
_Cor Simples;
_Comanda 4 canais do mesmo controlador.

_Mando RF 4 canales;
_Color simple;
_Comanda 4 canales desde el mismo controlador.

NOTA:
Este comando é compatível com todos os nossos controladores da série 211218.xxxx.
Este mando es compatible con todos nuestros controladores de la serie 211218.xxxx

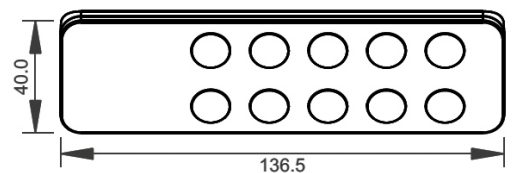



CONTROLADOR DIMMER PUSH DIM / RF
CONTROLADOR REGULABLE PUSH DIM / RF

IP20 230V 240W PL RF 1 CANAL 1A CANAL CE PUSH

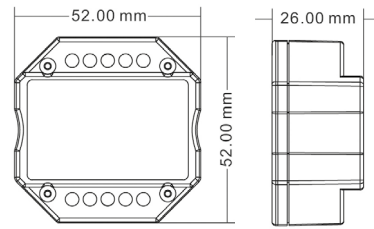

REF. 211244.3240

_Controlador ideal para todos os equipamentos de 240V com driver dimável; Devido ao seu tamanho poderá ser aplicado na caixa de aparelhagem de fundo duplo, possibilitando assim o seu modo de funcionamento push.

_Controlador ideal para todos los equipos de 240V con controlador regulable; Por su tamaño, se puede aplicar a una caja de distribución de doble fondo, habilitando así su modo de funcionamiento push.

CONTROLADOR ON/OFF
CONTROLADOR ON/OFF

IP20 PL RF 1 CANAL 6A CANAL 600W a 1440W CE PUSH

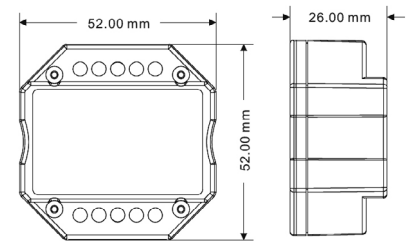

REF. 2113244.1720

_Controlador de 100-240Vac com saída 100-240Vac. Comandado por um comando RF (ref 2120244.DIM, 2120244.DIM4, 2121244.Dim) e/ou PUSH. Ideal para equipamentos que permitem um controlo ON/OFF através de um comando à distância tipo RF, efetuado por um switch/botão automático.

_Controlador de 100-240Vac con salida 100-240Vac. Controlado por un mando RF (ref 2120244.DIM, 2120244.DIM4, 2121244.Dim) y/o PUSH. Ideal para equipos que permiten el control de ENCENDIDO/APAGADO a través de un control remoto tipo RF, realizado por un interruptor/botón automático.

CONTROLADOR DIMMER / AC PUSH & TRIAC
CONTROLADOR REGULABLE / AC PUSH & TRIAC

IP20 12-48 VDC PL 1 CANAL 15A CANAL CE TRIAC PUSH

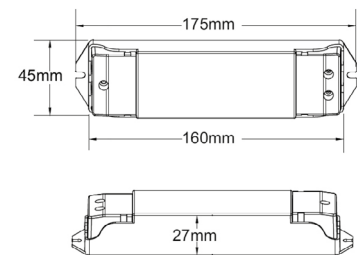

REF. 212644.6360

_Compatível com dimmers de corte de fase universal. Para trabalhar com repetidor de potência para expandir a potência de saída ilimitadamente.

_Compatible con ajustadores de fase universales corte. Para trabajar con el repetidor de potencia para expandir la potencia de salida ilimitadamente.

CONTROLADOR DIMMER / RF / AC PUSH
CONTROLADOR REGULABLE / RF / AC PUSH

IP20 240V AC PL 1 CANAL 15A CANAL 360W CE NOVO NUEVO

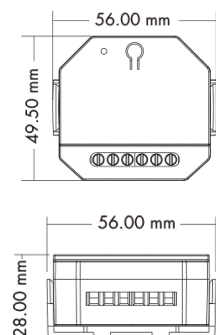

REF. 211174.3360

_Compatível com comando RF 2.4G para controlo de uma ou múltiplas zonas. Ligação com interruptor de pressão AC.

_Compatible con mando RF 2,4G para controlar una o varias zonas. Conexión con interruptor de presión AC.

COMANDOS RECOMENDADOS
MANDOS RECOMENDADOS

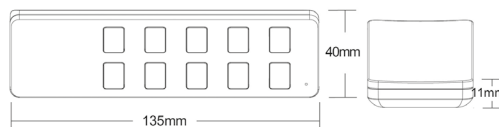

REF. 2120244.DIM

Comando RF 1 Zona Control Cor Simples ECO

Mando RF 1 Zona Control Color Simple ECO

REF. 2120244.DIM4

Comando RF 4 Zonas (4 controladores) Control Cor Simples ECO

Mando RF 4 Zonas (4 controladores) Control Color Simple ECO

_Aplice ao controlador de LED de cor simples ou de cor dupla. Cada comando pode corresponder a um ou mais recetores. Opera com a luz indicadora LED. Frequência: 2.4GHz. Com um íman na parte traseira, pode ser facilmente fixado no suporte ou em qualquer superfície metálica.

_Aplicar al controlador LED de un solo color o de dos colores. Cada mando puede corresponder a uno o más receptores. Funciona con indicador luminoso LED. Frecuencia: 2,4 GHz. Con un imán en la parte posterior, se puede fijar. fácilmente al soporte o a cualquier superficie metálica.

NOTA:

Este comando funciona com os controladores 211244.3240, 211243.696.

Este mando funciona con os controladores 211244.3240, 211243.696.



REF. 2121244.DIM

Comando RF Touch 1 Zona Control Cor Simples ECO

Mando RF Touch 1 Zona Control Color Simple ECO

NOTA:

Funciona com os controladores 211244.3240, 211243.696.

Funciona con os controladores 211244.3240, 211243.696.

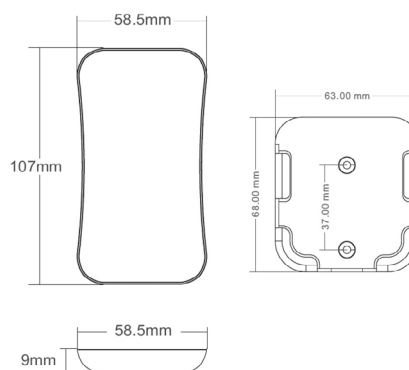

CONTROLADOR COR SIMPLES
CONTROLADOR COLOR SIMPLE



REF. 211243.696

Controlador Dimmer Cor Simples
Controlador Regulable Color Simple

_Um controlador de RF aceita até 10 comandos;
_Função de transmissão automática: o controlador transmite automaticamente o sinal para outro controlador com distância de controle de 30m;
_Sincroniza em vários controladores.

_Un controlador RF acepta hasta 10 mandos;
_Función de transmisión automática: el controlador transmite automáticamente la señal a otro controlador con una distancia de control de 30m;
_Se sincroniza a través de múltiples controladores.

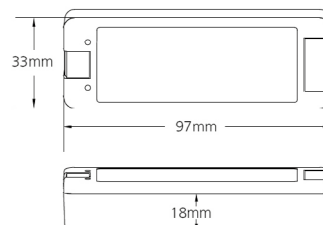

CONTROLADOR RGB

CONTROLADOR RGB



REF. 211245.4288

Controlador Dimmer RGB
Controlador Regulable RGB

_Um controlador de RF aceita até 10 comandos.
Ao usar com luz RGB, no modo 10 dinâmico, inclui estilo de mudança gradual. 4096 níveis de 0 a 100% de escurecimento suave, sem flash.
Sincroniza em vários controladores.

_Un controlador RF acepta hasta 10 mandos.
Cuando se usa con luz RGB, en 10 modos dinámicos, incluye estilo de cambio gradual. 4096 niveles de 0 a 100 % atenuación suave, sin flash.
Se sincroniza a través de múltiples controladores.

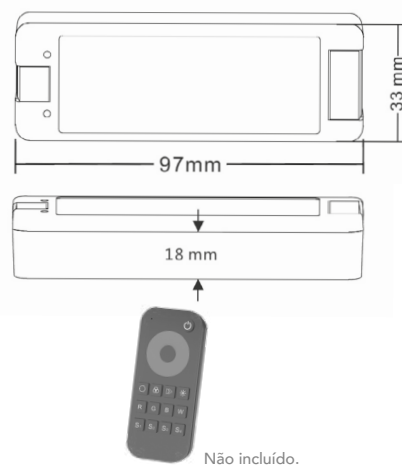

CONTROLADOR RGB+W

CONTROLADOR RGB+W



REF. 211243.4480

Controlador RGB 4 Canais (c/ controlo de frequência)
Controlador RGB 4 Canales (c/ control de frecuencia)

_Um controlador de RF aceita até 10 comandos.
Possibilidade de controlo da frequência de saída. Sincroniza em vários controladores. Frequência PWM 2000 / 500Hz selecionável. Ao usar com luz RGB / RGBW, no modo 10 dinâmico, inclui estilo de mudança gradual.

_Un controlador RF acepta hasta 10 mandos. Posibilidad de controlar la frecuencia de salida. Se sincroniza a través de múltiples controladores. Frecuencia PWM 2000/500Hz seleccionable. Cuando se usa con luz RGB/RGBW, en 10 modos dinámicos, incluye estilo de cambio gradual.

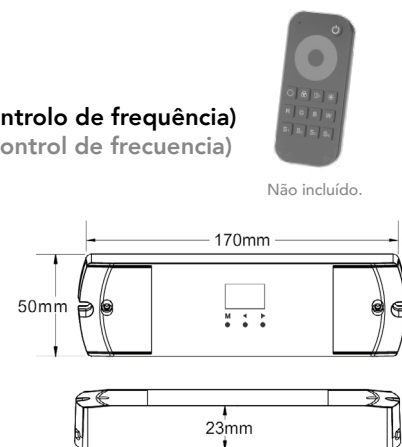

CONTROLADOR RGB+W

CONTROLADOR RGB+W



REF. 211243.4288

Controlador Dimmer RGB+W
Controlador Regulable RGB+W

_Um controlador de RF aceita até 10 comandos;
_Ao usar com luz RGB / RGBW, no modo 10 dinâmico, inclui estilo de mudança gradual;
_Sincroniza em vários controladores.

_Un controlador RF acepta hasta 10 mandos;
_Cuando se usa con luz RGB/ RGBW, en 10 modos dinámicos, incluye estilo de cambio gradual;
_Se sincroniza a través de múltiples controladores.

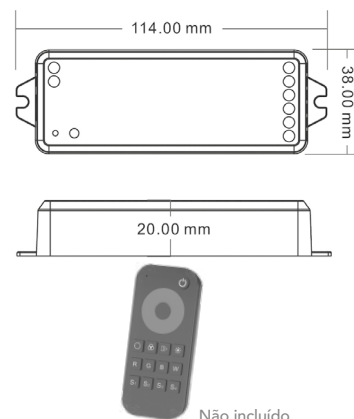

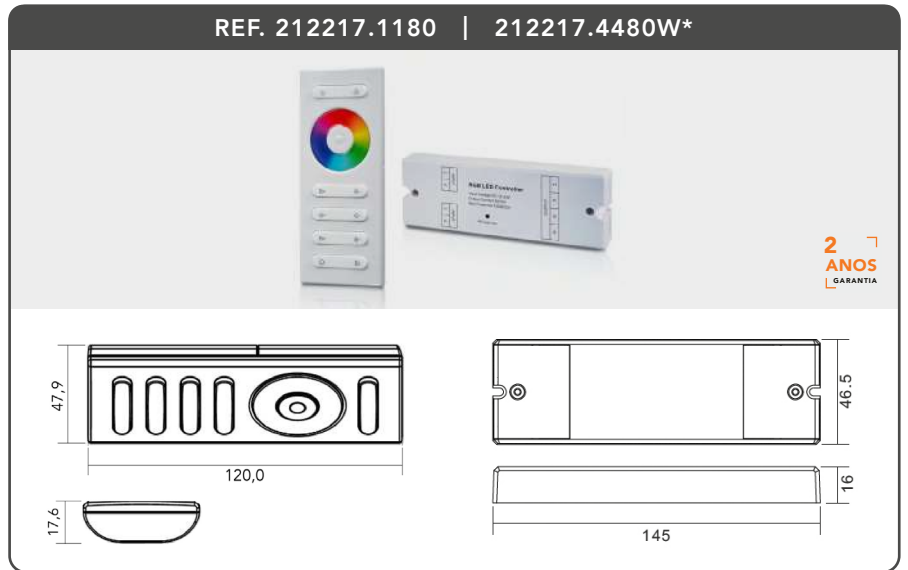

REF.	TENSÃO TENSION	POTÊNCIA POTENCIA	CORRENTE CORRIENTE	ALCANCE ALCANCE	Nº CANAIS N.º CANALES	CONTROLO CONTROL	FUNÇÃO FUNCIÓN
211243.4600	12-48Vdc	5x(60 - 120)W	5A/CH (12-24V) 4A/CH (36-48V)	30m Campo aberto	5	Controlo Push + RF Controla até 10 comandos	Controlador RGB+W+WW ECO
212217.1180*	12-24Vdc	180W (12Vdc) 360W (24Vdc)	5A/CH	-	3	Controlo RF Controla até 100 controladores	Controlador RGB
212217.4480W*	12-24Vdc	240W (12Vdc) 480W (24Vdc)	5A/CH	-	4	Controlo RF Controla até 100 controladores	Controlador RGB+W
2120244.RGBW	3V (2xAAA)	-	>5mA	30m Campo aberto	1 Zona	Controlo Touch	Comando RGB+W ECO
2120244.RGBW4	3V (2xAAA)	-	>5mA	30m Campo aberto	4 Zonas	Controlo Touch	Comando RGB+W ECO

* Vendido em kit (comando + controlador) / Se vende en kit (mando + controlador)

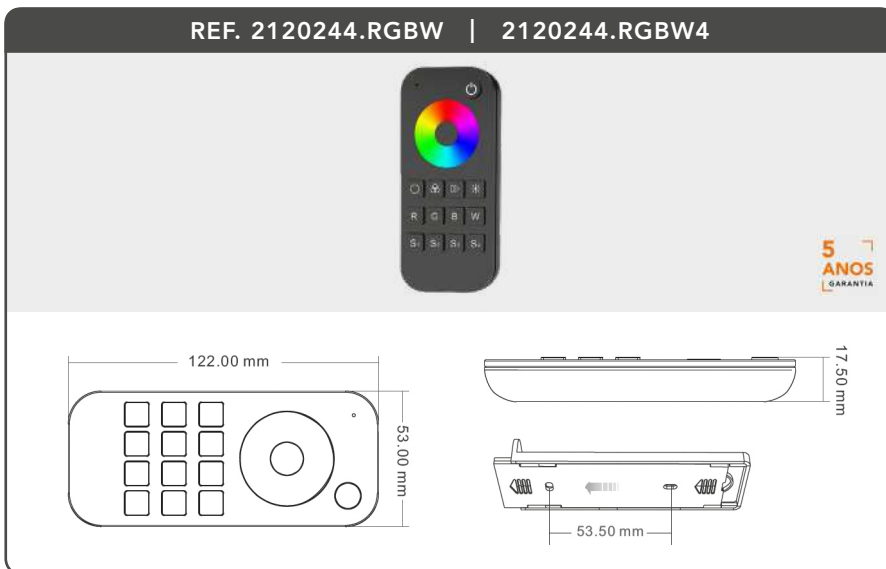

COMANDO RECOMENDADO
MANDO RECOMENDADO

Comando RF com touch para seleção de cores, permite programar até 4 canais e controlar 4 zonas independentes. Inclui botão direto para luz branca e opera a 2.4GHz.

Mando RF con pantalla táctil para seleccionar colores, permite programar hasta 4 canales y controlar 4 zonas independientes. Incluye botón directo para luz blanca y funciona a 2,4 GHz.

Este comando funciona com os seguintes controladores: | Este comando funciona con los siguientes controladores:

211243.4288 | 211243.4480 | 211245.4288

_COMANDOS RECOMENDADOS
MANDOS RECOMENDADOS

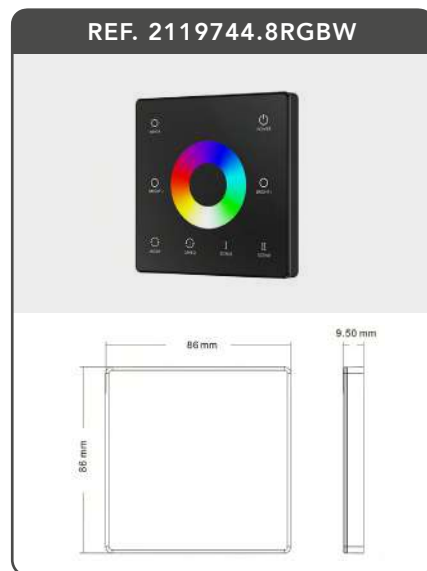
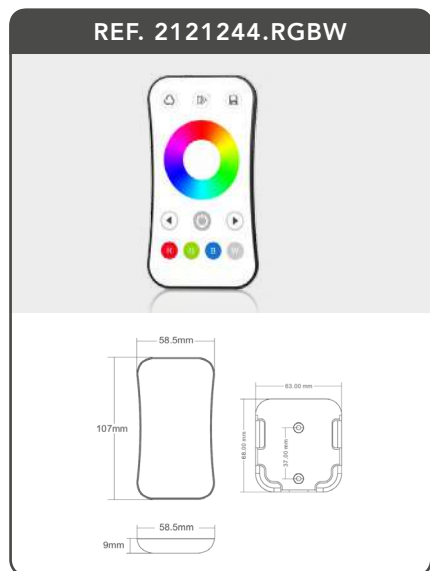

REF.	TENSÃO TENSION	CORRENTE CORRIENTE	Nº CANAIS N.º CANALES	CONTROLO CONTROL	FUNÇÃO FUNCIÓN
2121244.RGBW	3Vdc	>5mA	4	Controlo Cor RGB	Comando RF Mando RF
2120244.RGBW+WW	3Vdc	>5mA	4	Controlo RGB+ W+WW ECO	Comando RF Mando RF
2119744.8RGBW	3Vdc	<8mA	1 Zona	RGB+W Touch	Comando Touch Parede Mando Touch de pared
2129744.8DIM	3Vdc	<8mA	1 Zona	Diming	Comando Touch Parede Mando Touch de pared
213144.2CH	100-240Vac	0.01A	2 Zonas	Push - RF	Módulo 2 Entradas Push - RF
2120178.4PT 2120178.4BR	3Vdc	>5mA	4 Zonas	RF: 4 Zonas Multi-Função	Comando RF Mando RF

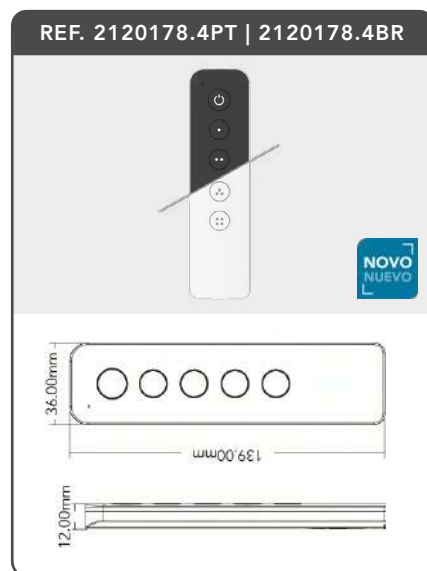
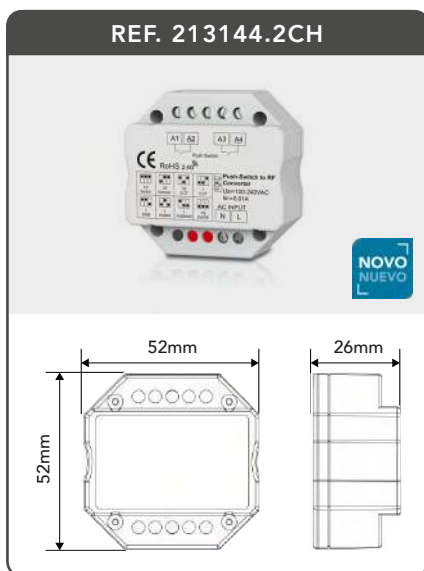
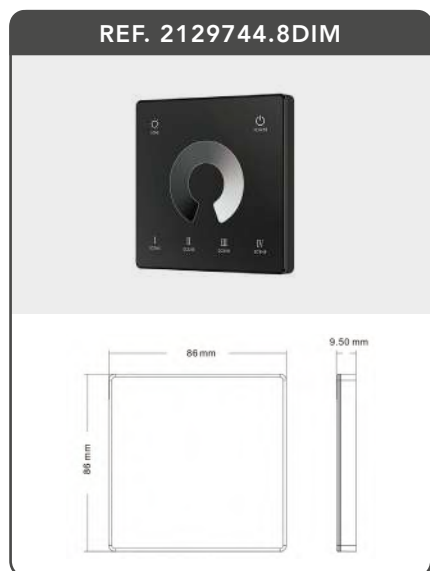

CONTROLADOR DE TEMPERATURA DE COR
CONTROLADOR DE TEMPERATURA DE COLOR



REF. 2111226.5360 Controlador de Temperatura de Cor c/ comando
Controlador de Temperatura de Color c/ mando

Controlador com comando incluído para regular a temperatura de cor via RF.
Sugestões de fita de led a utilizar:
_19,3W/mt 24Vdc IP20 Ref. 139151.19CT Pág. 239
_20W/mt 24Vdc IP20 Ref. 1322521.20CT Pág. 240

Controlador con mando incluído para regular la temperatura de color vía RF.
Sugerencias de tira LED a utilizar:
_19,3W/mt 24Vdc IP20 Ref. 139151.19CT Pág. 239
_20W/mt 24Vdc IP20 Ref.1322521.20CT Pág. 240

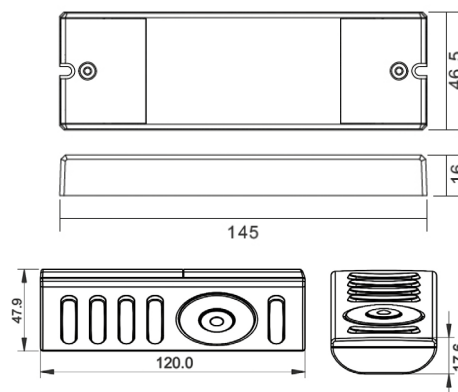

CONTROLADOR REGULAÇÃO DE TEMPERATURA RF E PUSH ECO
CONTROLADOR DE REGULACIÓN DE TEMPERATURA RF Y PUSH



REF. 2111271.4120

_Este controlador destina-se exclusivamente a fitas de led CCT com funcionamento de 2 fios. Para sugestões de fitas, consulte-nos.

_Este controlador está destinado exclusivamente a tiras de led CCT con funcionamiento a 2 hilos. Para sugerencias de tiras, contáctenos.

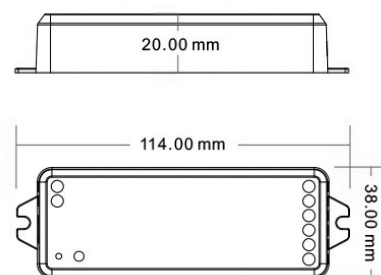

COMANDO RF 1 ZONA CONTROL TEMPERATURA DE COR ECO
MANDO RF 1 ZONA CONTROL DE TEMPERATURA DE COLOR ECO



REF. 2120271.1CT

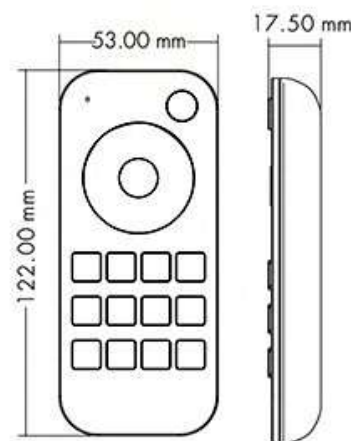

_CONTROLO DE ESCADAS
CONTROL DE ESCALERAS



REF. 2114244.4768 Controlador Sequencial de Degraus
Controlador Secuencial de Pasos

- _ Comando automático através de dois sensores de movimento ou de IR colocados nas duas extremidades da escada;
- _ Possibilidade do comando manual por botão PUSH;
- _ Controlo de fita de led cor simples ou fita endereçável tipo digital.
- Inclui 2 sensores de movimento e 1 sensor crepuscular
- _ Mando automático a través de dos sensores de movimiento o IR colocados en ambos extremos de la escalera;
- _ Posibilidad de control manual mediante PULSADOR;
- _ Control de tira de led de un solo color o tira direccionable de tipo digital.
- _ Incluye 2 sensores de movimiento y 1 sensor crepuscular

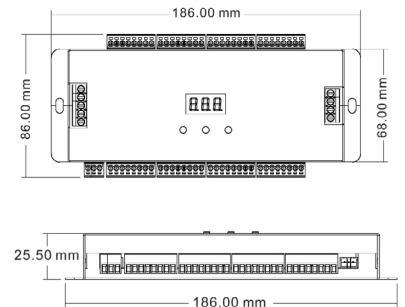

REF. 2114445.1086 Controlador Sequencial de Degraus
Controlador Secuencial de Pasos

- _ Controlador de iluminação para escadas até 32 degraus, com duplo sensor PIR e duplo interruptor de pressão, incluindo função de deteção de luz ambiente (daylight);
- _ 32 canais de saída em tensão constante para controlo de fitas led de baixa tensão, máx. 1A por canal;
- _ Ecrã com operação através de 3 botões.
- _ Controlador de iluminación para escaleras de hasta 32 peldaños, con doble sensor PIR y doble interruptor de presión, incluyendo función de detección de luz ambiental (daylight);
- _ 32 canales de salida en tensión constante para control de tiras LED de baja tensión, máx. 1 A por canal;
- _ Pantalla con funcionamiento mediante 3 botones.
- _ Incluye 2 sensores de movimiento y 1 sensor crepuscular

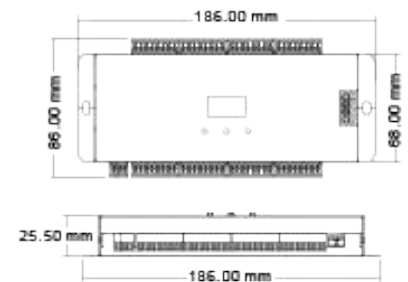

_SENSORES



REF. 2226262.1330

- Sensor Movimento 30° para encastrar em escadas**
Sensor de movimiento 30° para empotrar en escaleras
_Alcance: 3mt



REF. 2229262.114

- Sensor IR para encastrar em escadas**
Sensor IR para empotrar en escaleras
_Alcance: 1,4mt



REF. 2226262.1310

- Sensor Movimento 10° Encastre Escadas c/ cabo 3 fios + Conector**
Sensor Movimento 10° Empotrado Escaleras con cable de 3 hilos + Conector
_Alcance: 2,5mt



CONTROLADORES | RF

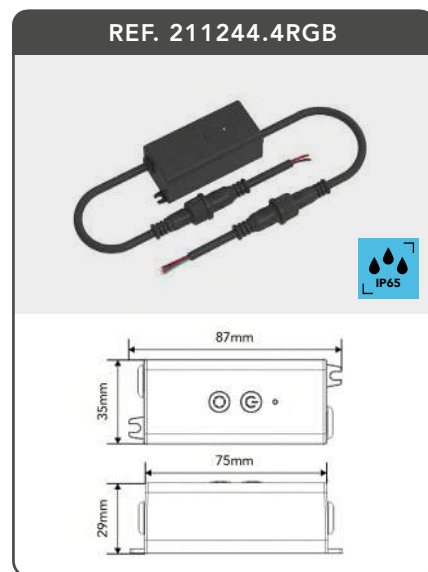
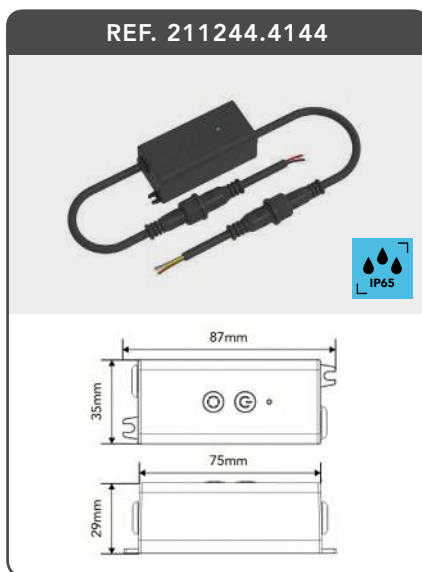
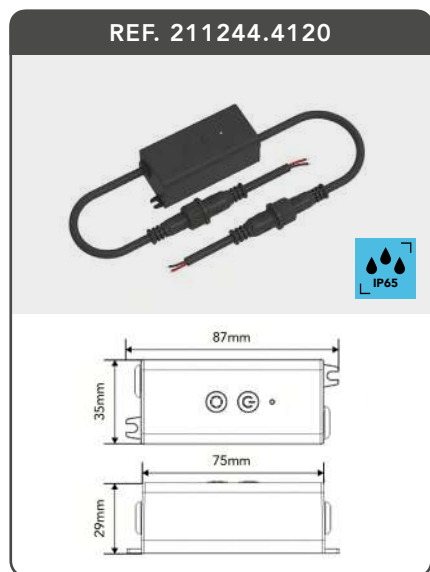

REF.	TENSÃO TENSION	POTÊNCIA POTENCIA	CORRENTE CORRIENTE	Nº CANAIS N.º CANALES	CONTROLO CONTROL	FUNÇÃO FUNCIÓN
211244.4120	12-24V	60W - 12V 120W - 24V	5A	1CH	2 Botões Dimming	Controlador RF
211244.4144	12-24V	72W - 12V 144W - 24V	3A/CH	2CH	2 Botões CCT	Controlador RF
211244.4RGB	12-24V	54W - 12V 108W - 24V	1,5A/CH	3CH	2 Botões RGB	Controlador RF
211244.4RGB+CCT	12-24V	60W - 12V 120W - 24V	1A/CH	5CH	2 Botões RGB + CCT	Controlador RF
211244.4RGBW	12-24V	48W - 12V 96W - 24V	1A/CH	4CH	2 Botões RGBW	Controlador RF

*Comandos sugeridos / Comandos sugeridos

REF.: 2120244.DIM; 2121244.DIM; 2120244.RGBW; 2121244.RGBW; 2120244.RGB+WW; 2119744.8RGBW; 2129744.8DIM; 213144.2CH; 2120178.4PT / 4BR

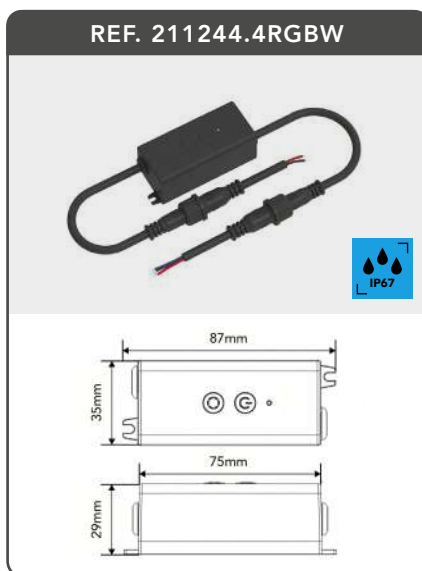
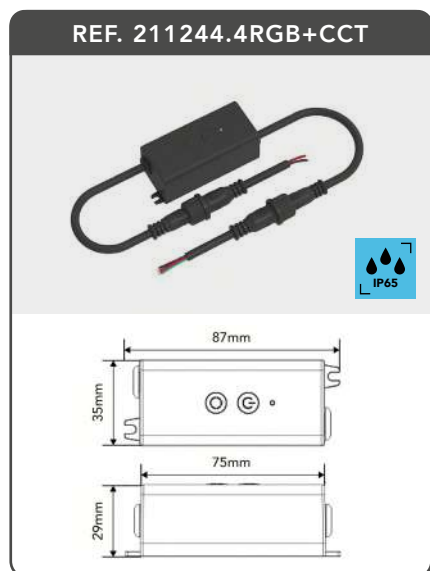

CONTROLADORES | WI-FI + RF

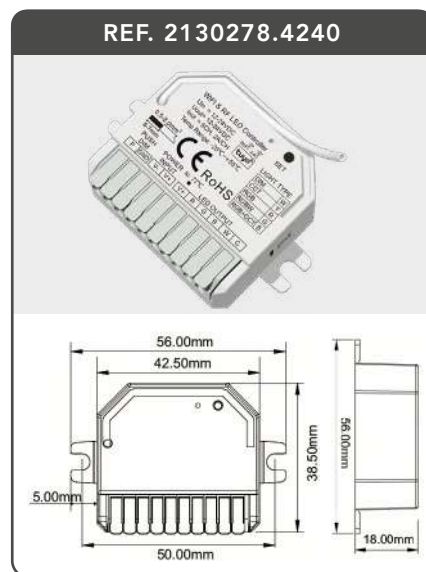
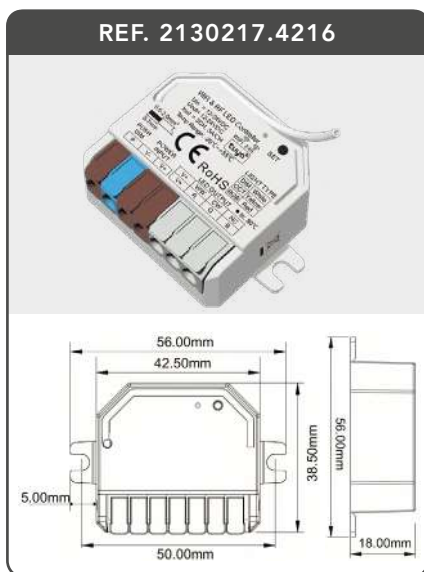
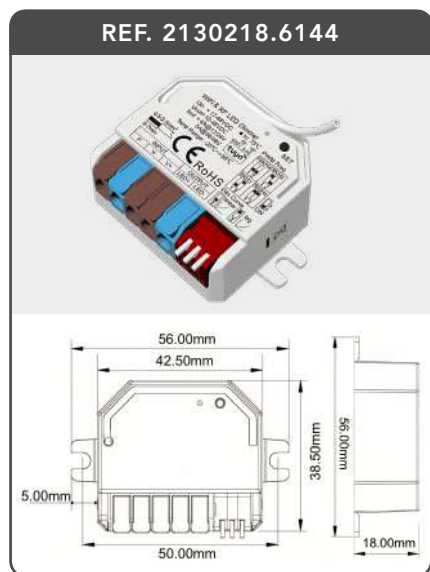

REF.	TENSÃO TENSION	POTÊNCIA POTENCIA	CORRENTE CORRIENTE	N° CANAIS N.º CANALES	CONTROLO CONTROL	FUNÇÃO FUNCIÓN
2130218.6144	12-48V	72W - 12V 144W - 24V 180W - 36V 240W - 48V	6A@12/24V 5A@36/48V	1	Push Dim RF/WiFi	Controlador Mini DIM
2130217.4216	12-24V	3x(36-72)W	9.5A	3	Push Dim RF/WiFi	Controlador Mini RGB
2130278.4240	12-24V	5x(24-48)W	10.5A	5	Push Dim RF/WiFi	Controlador Mini Multifunção

*Comandos sugeridos / Comandos sugeridos
 REF.: 2120244.DIM; 2121244.DIM; 2120244.RGBW; 2121244.RGBW; 2120244.RGB+WW; 2119744.8RGBW; 2129744.8DIM; 213144.2CH; 2120178.4PT / 4BR

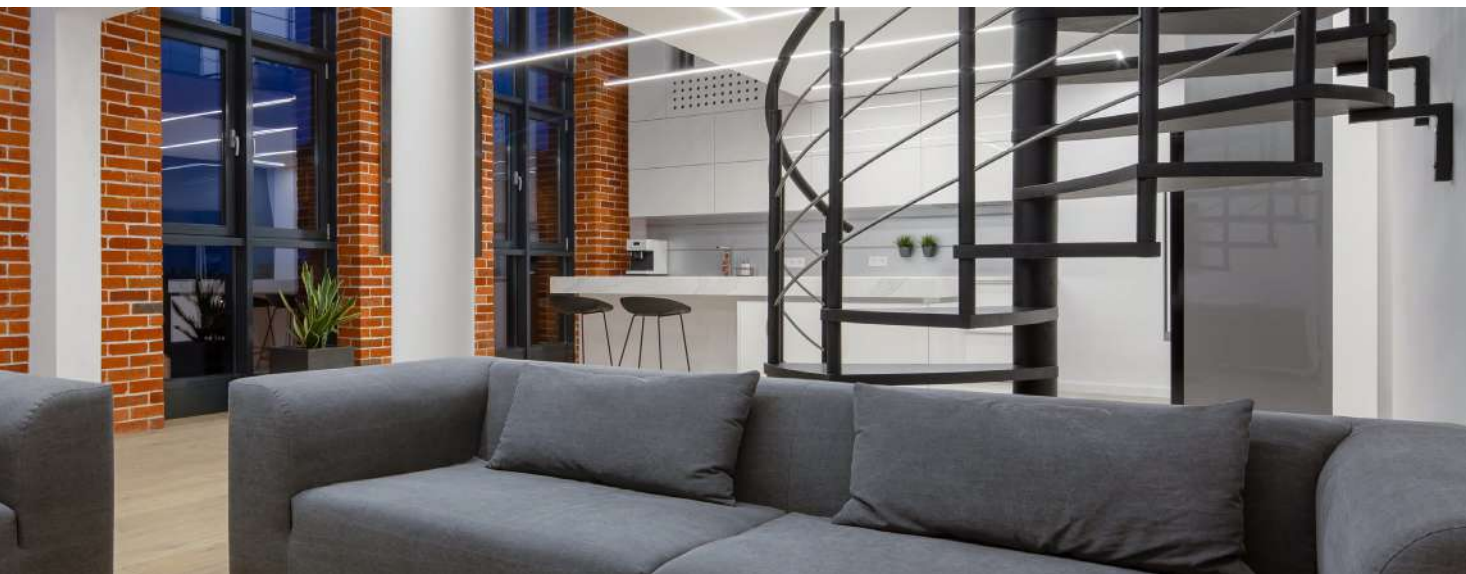



CASAMBI

CONTROLO CASAMBI

Smart Home

CONTROLADORES | 12-48VDC DIM/RGB/CCT/RGBW

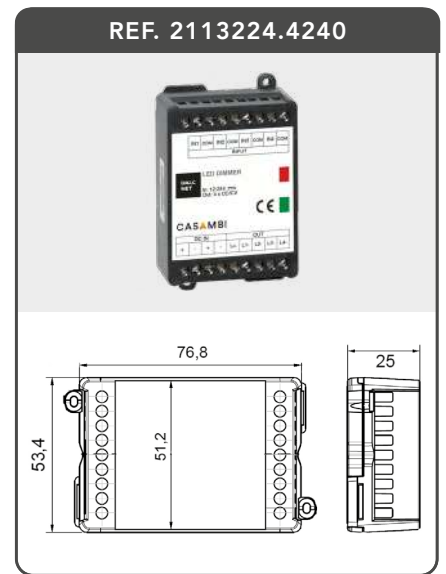
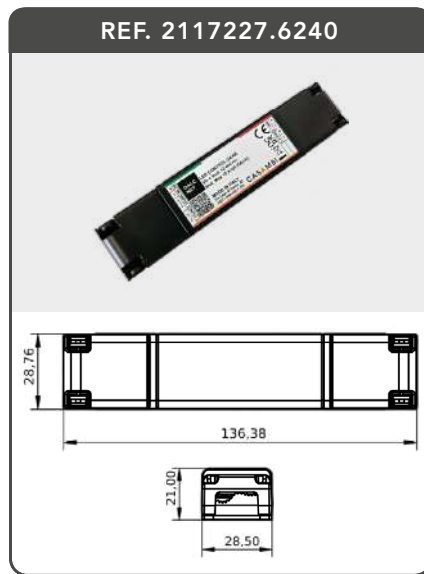
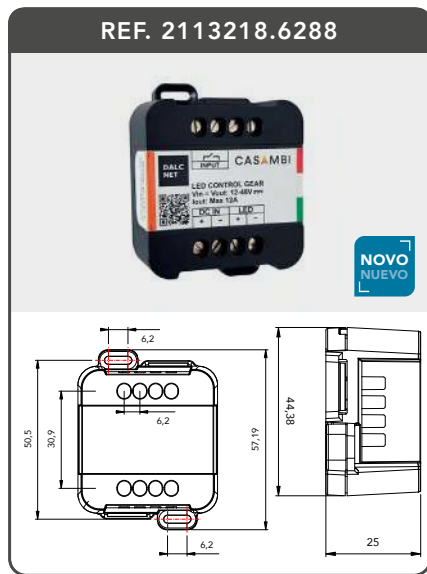

REF.	TENSÃO TENSION	POTÊNCIA POTENCIA	Nº CANAIS N.º CANALES	CONTROLO CONTROL	IP	FUNÇÃO FUNCIÓN
2113218.6288	12-48Vdc	288W/CH (24Vdc)	1	Casambi + 1xPush	IP20	Controlador DIM DIM
2117227.6240	12-48Vdc	120W/CH (24Vdc)	2	Casambi + 2xPush	IP20	Controlador Slim DIM DIM / CCT
2113224.4240	12-24Vdc	120W/CH (24Vdc)	4	Casambi + 4xPush	IP20	Controlador DIM DIM / CCT / RGB / RGB+W
2117227.4144N	12-24Vdc	144W/CH (24Vdc)	4	Casambi Bluetooth	IP20	Controlador Dim DIM / CCT / RGB / RGB+W
2117227.6288	12-48Vdc	120W/CH (24Vdc)	5	Casambi + 2xPush	IP20	Controlador Line DIM DIM / CCT / RGB / RGB+W / RGB +CCT
2138227.6960	12-48Vdc	192W/CH (24Vdc)	5	Casambi + 1xPush	IP20	7 em 1 Controlador DIM DIM / CCT / RGB / RGB+W / RGB +CCT

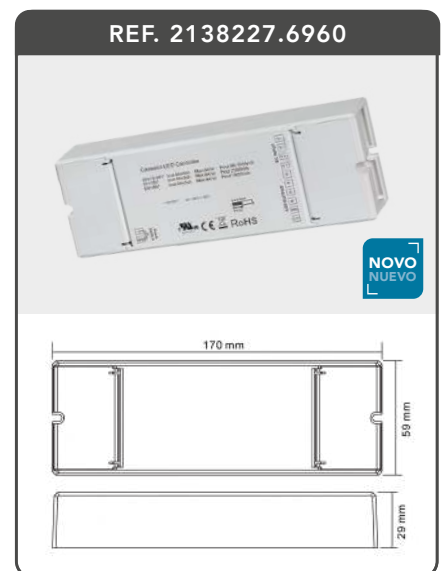
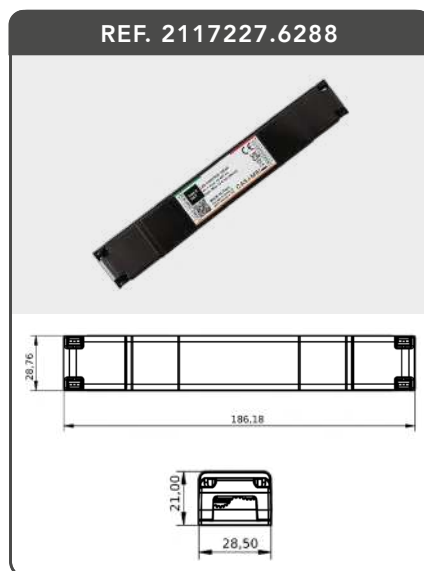
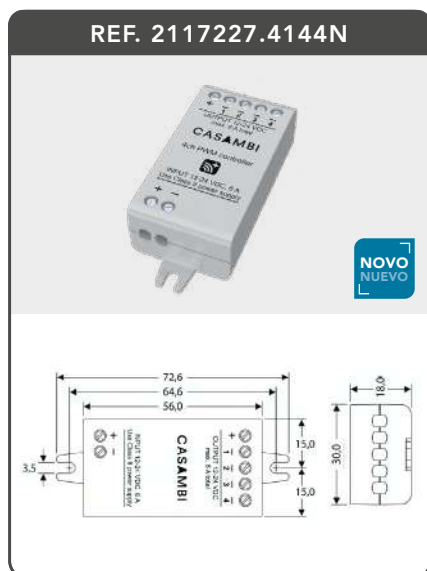

GATEWAY | GATEWAY DALI CASAMBI

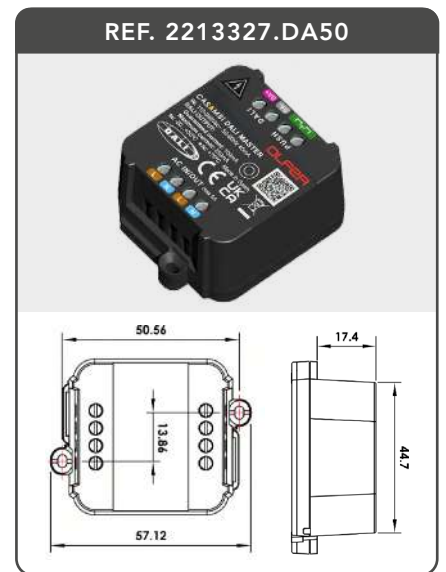
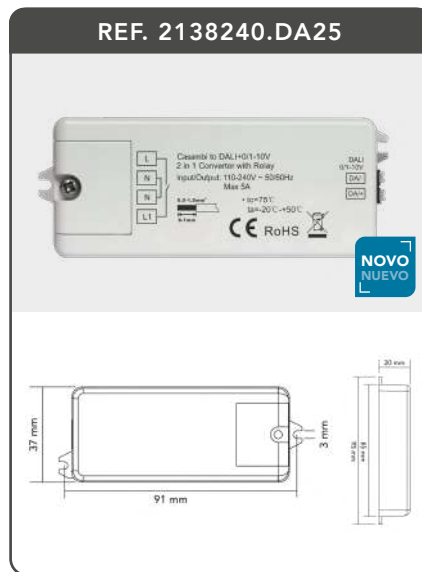
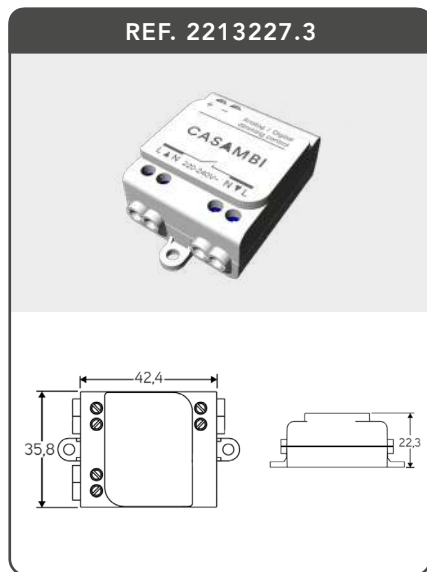

REF.	TENSÃO TENSION	Nº CANAIS N.º CANALES	CONTROLO CONTROL	FUNÇÃO FUNCIÓN
2213227.3	220-240Vac	1/0,6A	Casambi	Conversor Casambi - Dali2 (1xDrive, 1xEndereço) 0/1-10V
2138240.DA25	110-240Vac	1/1,6A	Casambi + 1xPush	Conversor Casambi - Dali2 (25xDrives, 25xEndereços) 0/1-10V
2213327.DA50	230Vac	-	Casambi + 1xPush	Conversor Casambi - Dali2 (52xDrives, 8xEndereços)
2117240.16	100-277Vac	-	Casambi	Conversor Casambi - Dali2 (16xDrives, 16xendereços)
2117240.32				Conversor Casambi - Dali2 (32xDrives, 32xendereços)
2117240.64				Conversor Casambi - Dali2 (64xDrives, 64xendereços)
2213227.DA	230Vac	-	Dali - Casambi	Conversor Dali - Casambi (1xEntrada, Dali para Casambi)

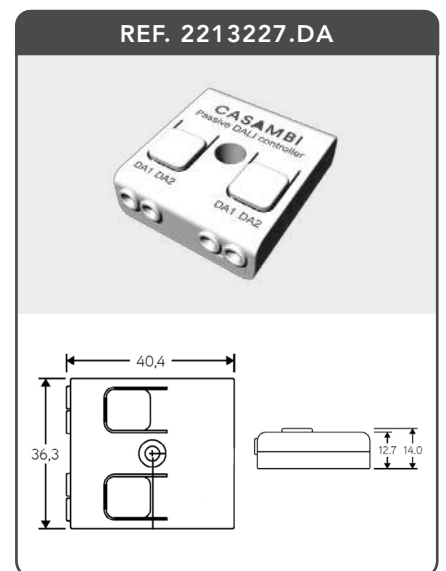
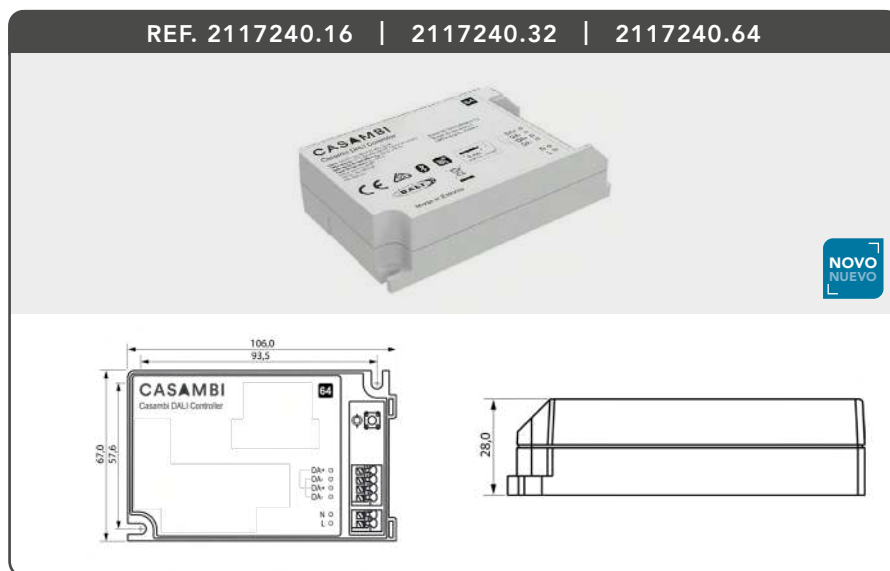

CONTROLADORES | TRIAC + ESTORES CASAMBI

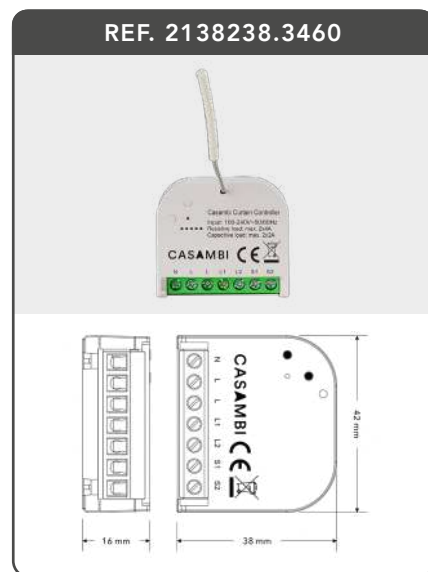
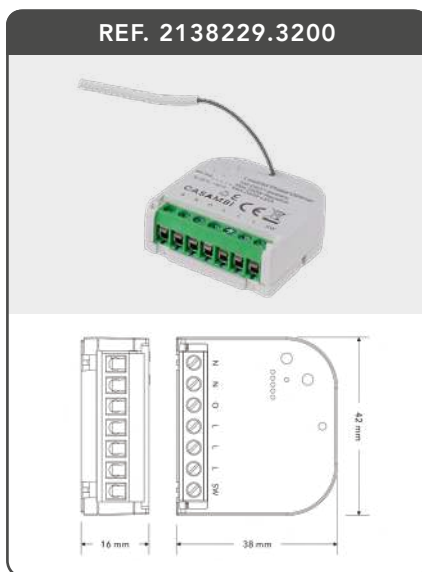
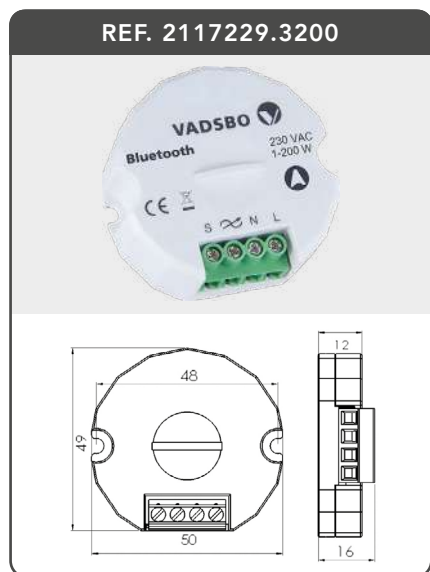

REF.	TENSÃO TENSION	POTÊNCIA POTENCIA	N.º CANAIS N.º CANALES	CONTROLO CONTROL	FUNÇÃO FUNCIÓN
2117229.3200	220-240Vca	200W	1	Casambi + 1xPush	Controlador DIM Dim Triac, On/Off
2138229.3200	100-240Vac	250W	1	Casambi + 1xPush	Controlador DIM Dim Triac
2138238.3460	100-240Vac	2x2A	2	Casambi + 2xPush	Contolador de Estores
2117253.3480	230Vac	2x2A	2	Casambi + 2xPush	Contolador de Estores

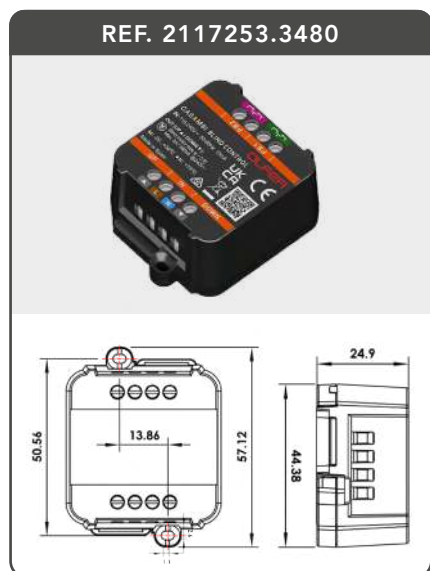

SUGESTÕES | SUGERENCIAS

Filtro de Proteção | Filtro de Protección
230Vac 480W Triac
REF. 2238280.3480

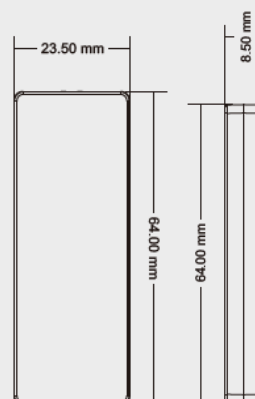
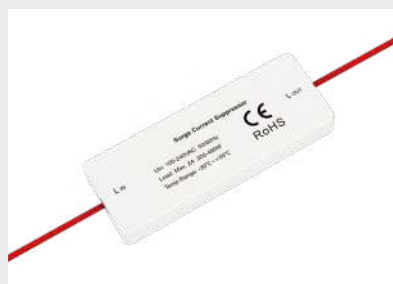

GATEWAY | ON/OFF CASAMBI

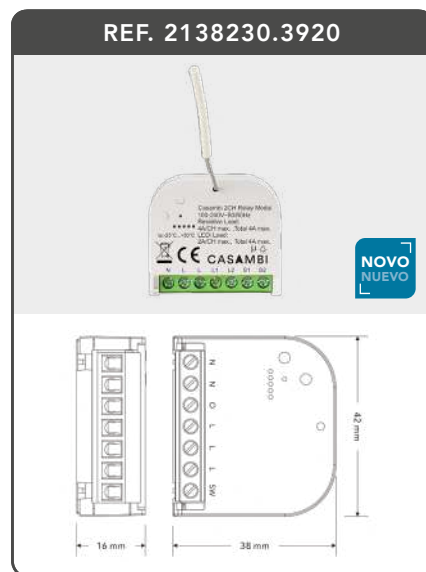
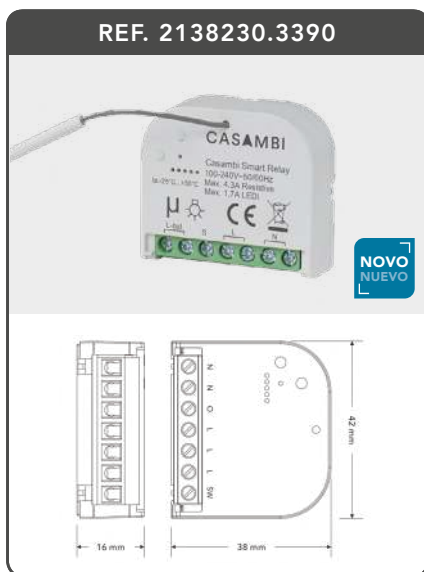
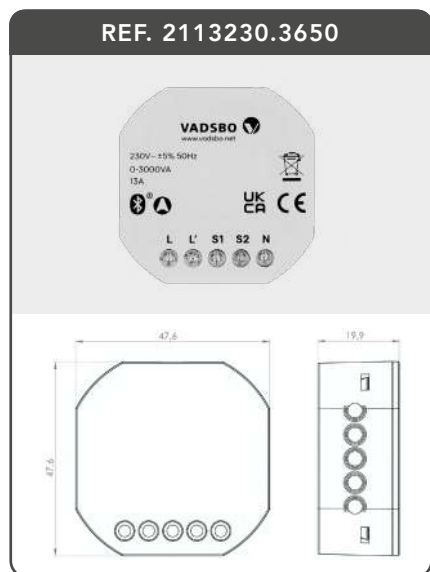

REF.	TENSÃO TENSION	POTÊNCIA POTENCIA	N.º CANAIS N.º CANALES	CONTROLO CONTROL	FUNÇÃO FUNCION
2113230.3650	220-240V	3000W	1	Casambi + 1xPush	Controlador Relé On/Off
2138230.3390	100-240Vac	390W	1	Casambi 1xPush	Controlador Relé On/Off
2138230.3920	100-240Vac	460W/CH	2x2A LED	Casambi + 2xPush	Controlador Relé 2xOn/Off
2138230.32300	24Vdc 110-240Vac	144W (24Vdc) 1380W (230Vac)	1	Casambi + 2xPush	Controlador Relé 24Vdc ou 230Vdc On/Off
2117230.123000	12-24Vdc 110-240Vac	72W (12Vdc) 144W (24Vdc) 1380W (230Vac)	1 Alimentação Saída Externa	Casambi + 1xPush	Controlador Relé 12Vdc ou 24Vdc ou 230Vdc On/Off
2117230.132300	24Vdc 110-240Vac	84W (24Vdc) 805W (230Vac)	2	Casambi + 2xPush	Controlador Relé 24Vdc ou 230Vdc On/Off

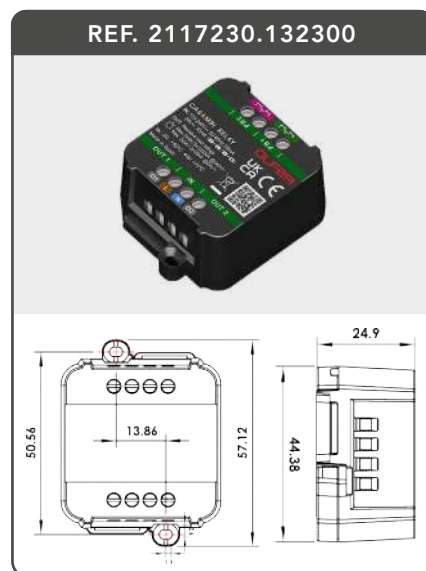
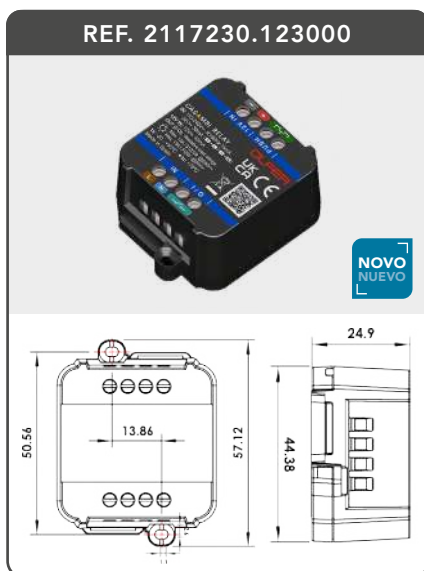
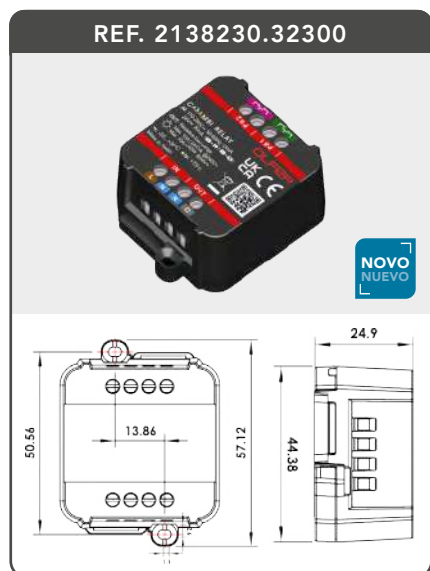

COMANDOS | CASAMBI

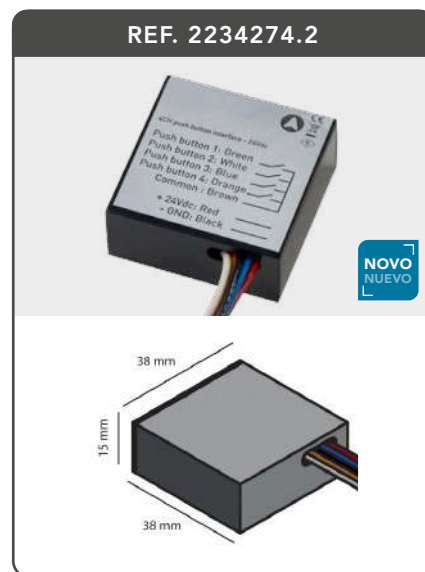
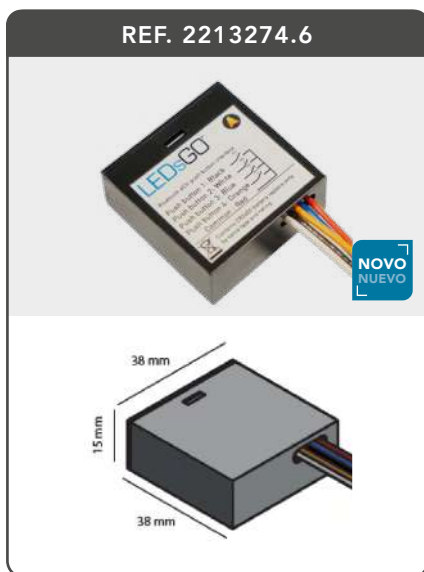
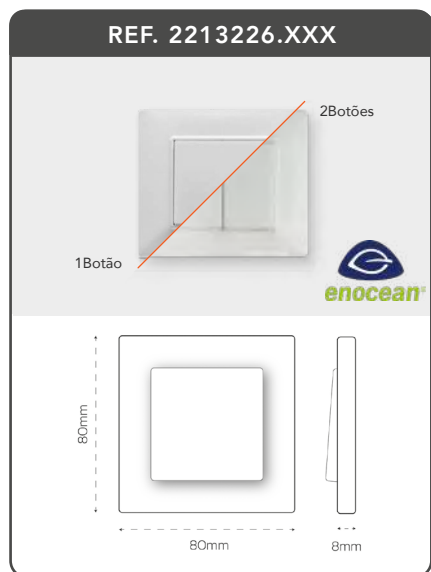

*Tecnologia EnOcean: sem necessidade de bateria/alimentação.
Tecnologia EnOcean: sin necesidad de batería/alimentación.

REF.	TENSÃO TENSION	ALCANCE ALCANCE	Nº CANAIS N.º CANALES	CONTROLO CONTROL	FUNÇÃO FUNCIÓN
2213226.1BR 2213226.2BR	Bateria Enocean	30m Campo aberto	2 4	1 Botão/Botón 2 Botões/Botones	Comando de Parede s/ bateria*
2213274.6	3V (CR2450)	50m Campo aberto	4	Push	Módulo 4 entradas c/ pilha
2234274.2	24Vdc	50m Campo aberto	4	Push	Módulo 4 entradas
2237226.4	100-240Vac	50m Campo aberto	4	Push	Módulo 4 entradas
2213226.74P	12-24Vdc 110-240Vac	300m Campo aberto	4	Push	Módulo 4 entradas
2213226.8PT 2213226.8BR	3V (CR2450)	60m Campo aberto	4	8 Botões Botones	Comando de Parede c/ pilha Preto e Branco Negro e Blanco

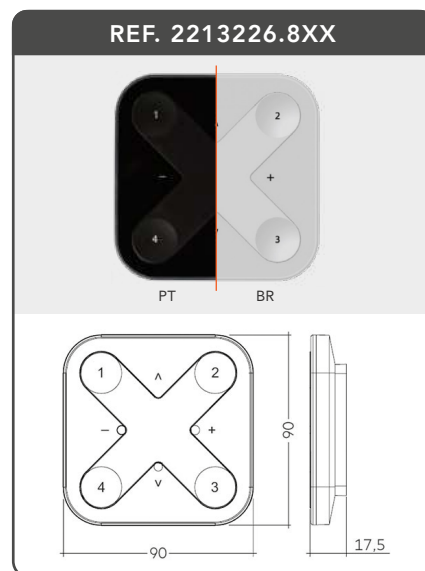
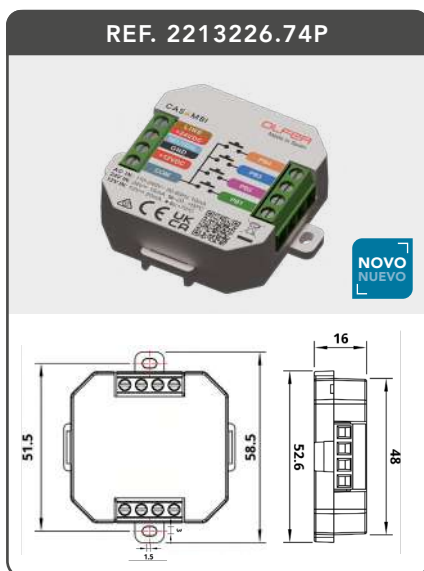
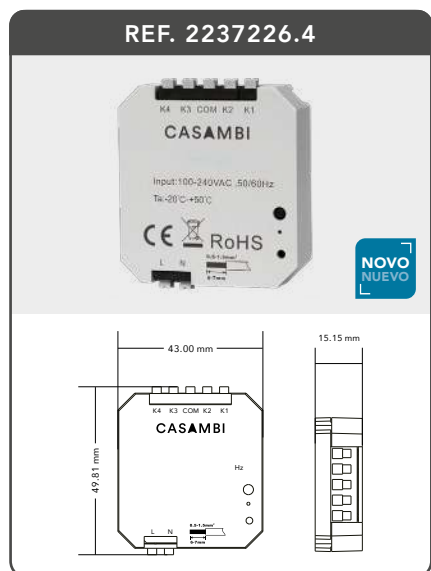

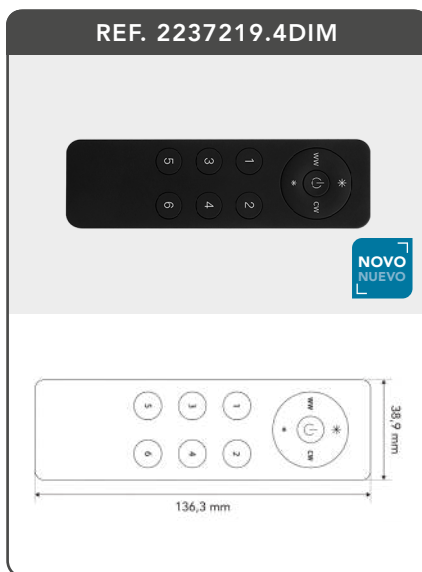

REF.	TENSÃO TENSION	ALCANCE ALCANCE	Nº CANAIS N.º CANALES	CONTROLO CONTROL	FUNÇÃO FUNCIÓN
2237219.5ROD	3Vdc (CR2450)	50m Campo aberto	5	5xBotões + Rotativo 4 Dim + 1 RGBW	Comando Rotativo + Bot. Mesa/Parede
2237219.4DIM	3Vdc (CR2025)	50m Campo aberto	6	6xBotões Dim + CCT	Comando DIM Comando remoto
2237218.4RGBW	4,5V (3xAAA)	50m Campo aberto	4 zonas	Paleta Cores RGB+W	Comando Remoto Bateria CCT/RGB/RGBW/RGB+CCT
2237218.TOUCH	100-240Vac	50m Campo aberto	1 - 4 Zonas	Controlo Touch	Comando Touch Encastre RGB / CCT

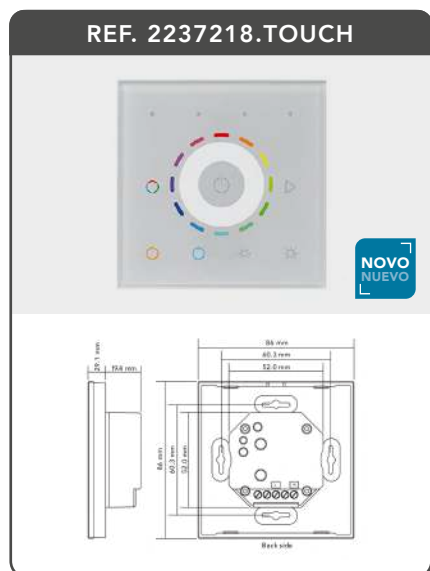

CONTROLO ESPECIAL | CASAMBI

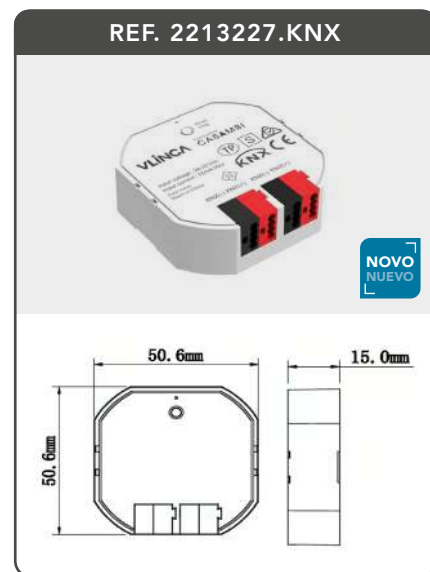
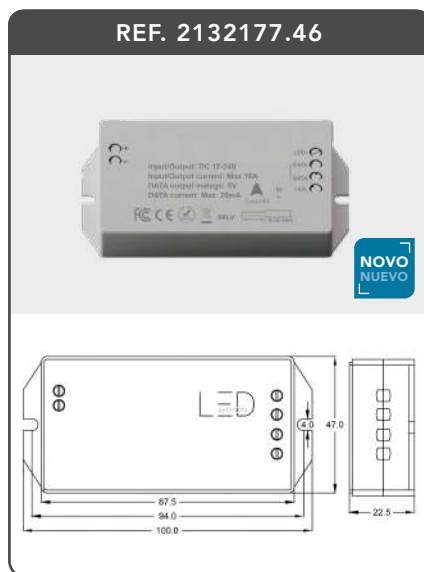
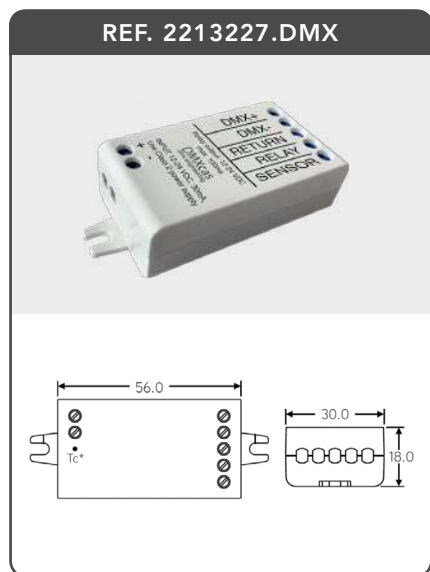

REF.	TENSÃO TENSION	POTÊNCIA POTENCIA	N.º CANAIS N.º CANALES	CONTROLO CONTROL	FUNÇÃO FUNCIÓN
2213227.DMX	12-24Vdc	-	8 DMX	Casambi - DMX-512	Conversor Casambi para DMX DIM / CCT / RGB / RGBW / RGB + CCT
2132177.46	12-24Vdc	240W (512 píxeis)	1	Casambi Pixel	Controlador Digital
2213227.KNX	Bus KNX	Alcance 50m	32	KNX - Casambi	Conversor KNX - Casambi
2213227.WEB	5Vdc (Transformador incluído)	-	-	Casambi WiFi + RJ45	Gateway com acesso remoto de controlo e programação Gateway con acceso remoto de control y programación

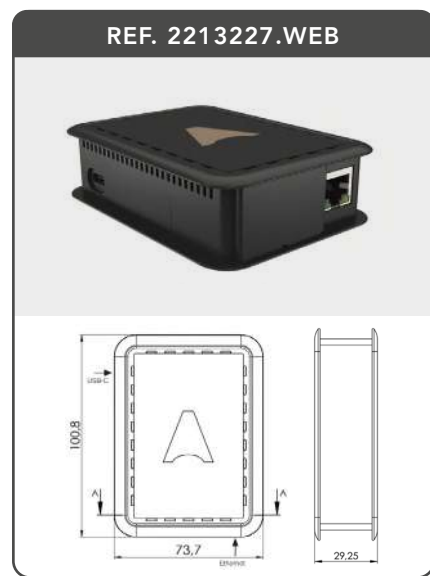
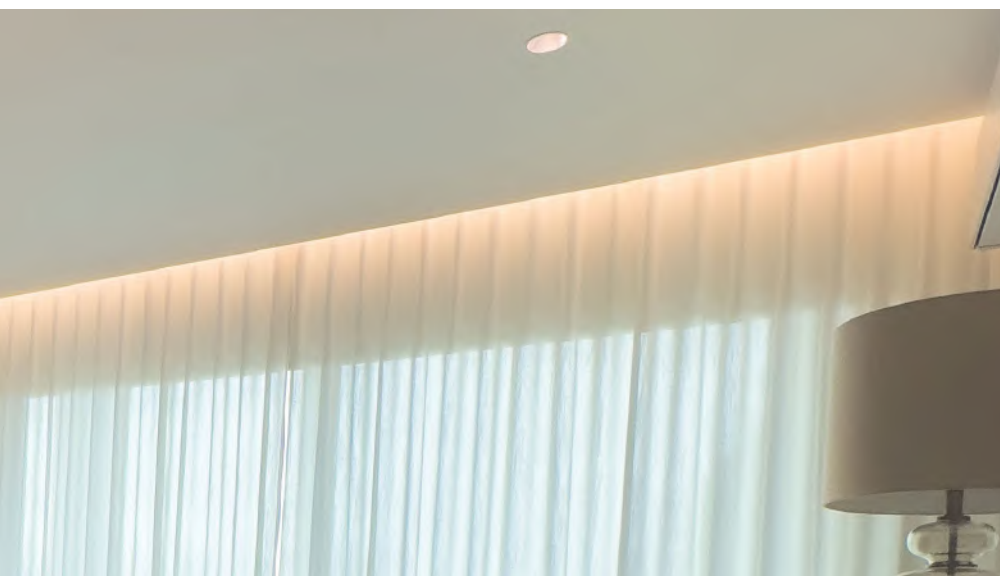

SENSORES | CASAMBI

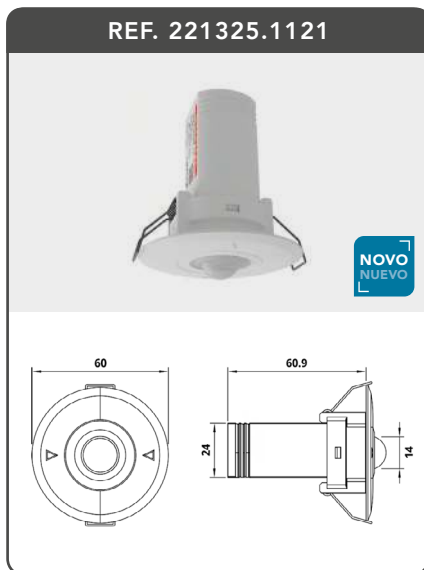
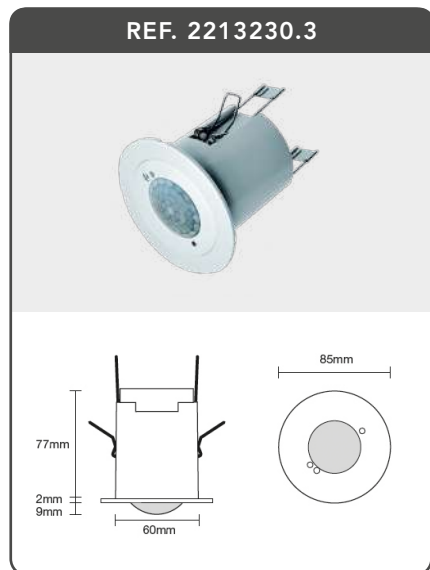

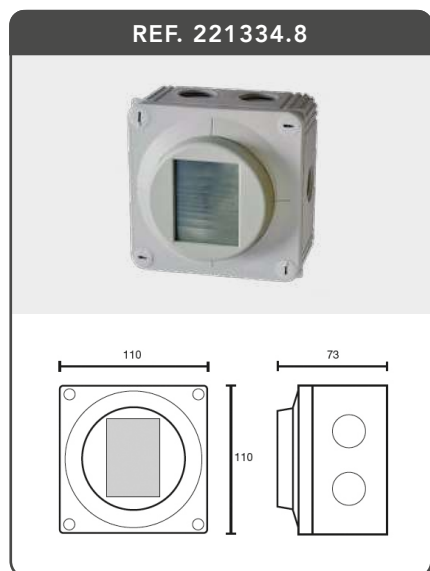

REF.	TENSÃO TENSION	POTÊNCIA POTENCIA	CONTROLO CONTROL	IP	FUNÇÃO FUNCIÓN	ALCANCE ALCANCE
2213230.3	230Vac	-	Casambi	IP20	Sensor de presença/movimento** Sensor de presencia/movimiento	360° - 7m
221325.1121	24Vdc 230Vac - 24Vdc Fonte Incluído	Dali 25 Drives	Casambi + Dali 2	IP20	Sensor de presença/luminosidade* Sensor de presencia/luminosidad	Move - 12m Presen - 7m
22237277.360DA	220-240Vac	Dali Broadcast Relé 10A	Casambi + Dali Bus ON/OFF	IP44	Sensor de movimento /presença/luminosidade Sensor de movimiento/presencia/luminosidad	Move - 8m Presen - 4m
221334.8	220-240Vac	-	Casambi	IP66	Sensor de movimento Sensor de movimiento	15x3m





FONTES DE ALIMENTAÇÃO E DRIVES | CASAMBI





REF. 2029851.2100

REF. 2029851.2150



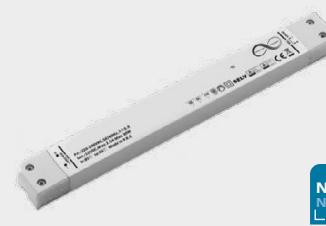

REF. 2029851.7100





REF.	TENSÃO TENSION	CORRENTE CORRIENTE	POTÊNCIA POTENCIA	CONTROLO CONTROL	FUNÇÃO FUNCIÓN
2029851.2100	24Vdc	4160mA	100W	Casambi + Push	Fonte CV Controlo Casambi
2029851.2150	24Vdc	6250mA	150W	Casambi + Push	Fonte CV Controlo Casambi
2029851.7100	48Vdc	2080mA	100W	Casambi + Push	Fonte CV Controlo Casambi
2029851.7150	48Vdc	3125mA	150W	Casambi + Push	Fonte CV Controlo Casambi
2019451.7713	9-52Vdc	700mA	26W	Casambi + Push	Driver CC Controlo Casambi
2019451.7741	9-52Vdc	700mA	42W	Casambi + Push	Driver CC Controlo Casambi

REF. 2029851.7150

REF. 2019451.7713

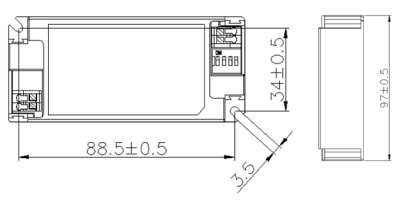
REF. 2019451.7741

FONTES DIMÁVEIS | PWN*

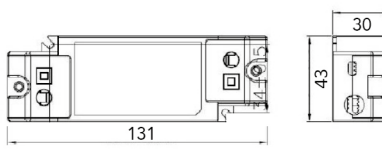

REF.	TENSÃO TENSION	POTÊNCIA POTENCIA	INPUT ENTRADA	OUTPUT SALIDA	CONTROLO CONTROL	DIMENSÃO DIMENSION
20766.160BLE	12Vdc	60W	90 - 305VAC	127 - 431VDC	Casambi PWM	150 x 53 x 35mm
20766.1120BLE		120W	90 - 305VAC	127 - 431VDC		191 x 63 x 37,5mm
20766.1200BLE		180W	-	-	Casambi PWM Dali2 + Push	
20766.260BLE	24Vdc	60W	90 - 305VAC	127 - 431VDC	Casambi PWM	150 x 53 x 35mm
20766.2120BLE		120W	90 - 305VAC	127 - 431VDC		191 x 63 x 37,5mm
20766.2200BLE		200W	-	-	Casambi PWM Dali2 + Push	

*A PWM está integrada no protocolo de controlo, à qual não precisa de Gateway Dali KNX. | PWM está integrado en el protocolo de control, que no requiere una gateway Dali KNX.





CONTROLLO DALI

Control DALI

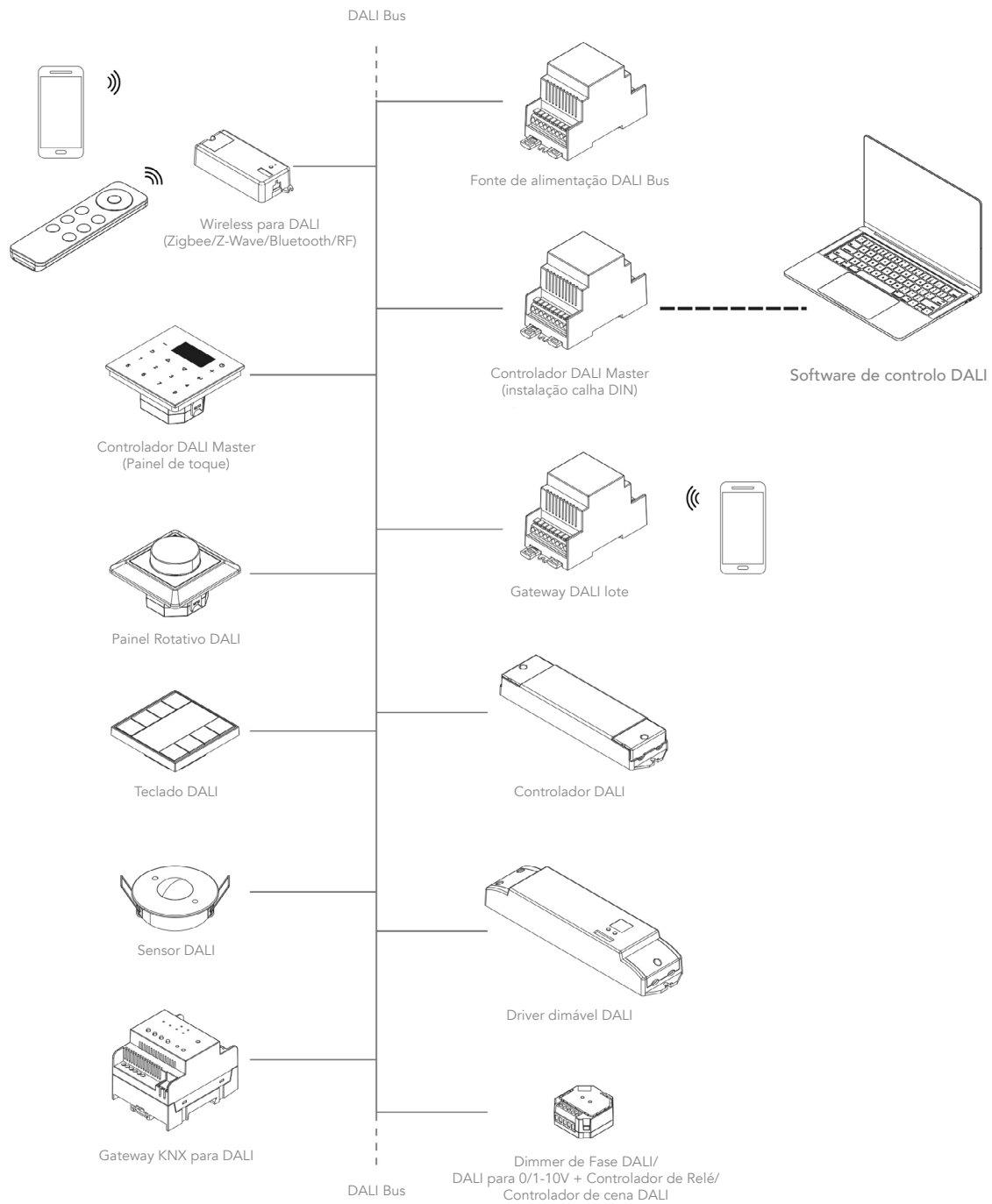

DALI CENTER

O DALI Center é uma plataforma implantada em computadores locais para gestão de iluminação de edifícios. Permite o controle individual ou centralizado da iluminação em diferentes áreas e fornece uma interface de análise energética. Através de recursos de automação de tempo e sensor, ajuda a melhorar a eficiência energética.

DALI Center es una plataforma implementada en ordenadores locales para la gestión de la iluminación de edificios. Permite el control individual o centralizado de la iluminación en diferentes zonas y proporciona una interfaz de análisis energético. A través de funciones de automatización de tiempo y sensores, ayuda a mejorar la eficiencia energética.

GATEWAYS DALI

GATEWAY DALI MASTER 2 UNIVERSOS DALI



REF. 2110373.2DA

IP20	230V	USB	DALI 2
2 CANAIS		SELV	CE

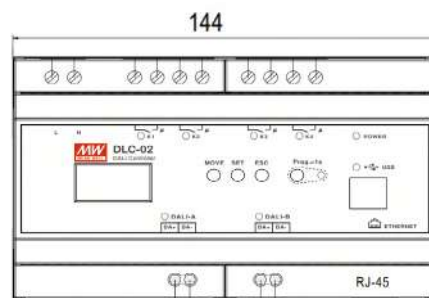

Gateway Dali-2 master

- _ Dois canais de DALI Bus independentes com fonte de alimentação DALI integrada (até 250mA por BUS)
- _ Conecte até 2x64 saídas Dali-2 e 2x12 dispositivos de entrada DALI
- _ Máximo 16 grupos e 16 cenas por canal
- _ Suporte para dispositivo de controle de cores DT8 (temperatura de cor, RGB (W) e coordenada xy)
- _ Fácil instalação e configuração através de software DLC-02 para PC

Gateway Dali-2 maestro

- _ Dos canales de Bus DALI independientes con fuente de alimentación DALI integrada (hasta 250mA por BUS)
- _ Conecte hasta 2x64 salidas Dali-2 y 2x12 dispositivos de entrada DALI
- _ Máximo 16 grupos y 16 escenas por canal
- _ Soporte para dispositivo de control de color DT8 (temperatura de color, RGB (W) y coordenada xy)
- _ Fácil instalación y configuración mediante el software DLC-02 para PC

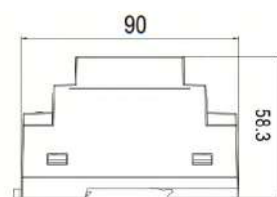

REPETIDOR DALI BROADCAST REPETIDOR DE TRANSMISIÓN DALI



REF. 216226

- _ Módulo de transmissão DALI 4 em 1 DT6 e DT8, circuito DALI
- _ Recebe comandos DT6/DT8 do circuito principal DALI como um reator com um único endereço
- _ Vários módulos podem ser conectados ao circuito principal DALI para estabelecer vários subcircuitos DALI
- _ Módulo de transmisión DALI 4 en 1 DT6 y DT8, circuito DALI
- _ Recibe comandos DT6/DT8 del circuito principal DALI como reactor con una única dirección
- _ Se pueden conectar varios módulos al circuito principal DALI para establecer varios subcircuitos DALI

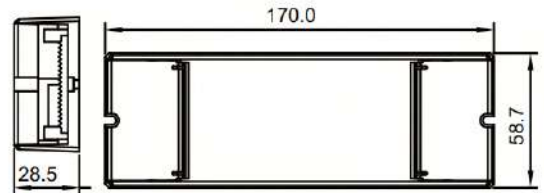

CONTROLADOR / CONVERSOR PUSH-DALI CONTROLADOR / CONVERTIDOR PUSH-DALI

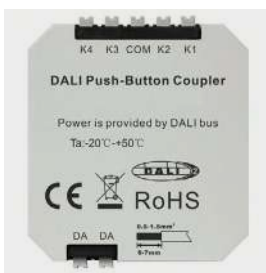

REF. 2112226 **4** CANAIS

Conversor PUSH-DALI 4 canais
Convertidor PUSH-DALI 4 canales

REF. 2132272.4 **4** CANAIS

Conversor PUSH-DALI 4 canais c/NFC
Convertidor PUSH-DALI 4 canales c/ NFC

REF. 2132272.2 **2** CANAIS

Conversor PUSH-DALI 2 canais c/ NFC
Convertidor PUSH-DALI 2 canales c/ NFC

Este controlador necessita de fonte Dali e é alimentado pelo BUS Dali.
Este controlador necesita una fuente Dali y se alimenta mediante el BUS Dali.

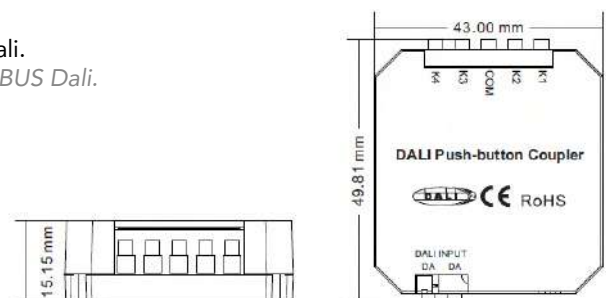

CONVERSORES

CONVERSORES PUSH-DALI
CONVERTIDORES PUSH-DALI



REF. 211226.3

Conversor Push - RF - Dali
Convertidor Push - RF - Dali

_ Conversor Push-Dali converte um sinal de botão de pressão (push) em Dali;
_ Ideal para utilização num grupo de drivers de Dali numa instalação sem gestão de Dali;
_ Este conversor gere um único canal Dali (controla um circuito);
_ Para uma boa utilização deste conversor será sempre necessária a aplicação de uma fonte Bus Dali (ref. 201281.1010 e 20981.1010).

_ Push-Dali converter convierte la señal de un botón pulsador en Dali;
_ Ideal para usar en un grupo de drivers Dali en una instalación sin gestión Dali;
_ Este convertidor gestiona un solo canal Dali (controla un circuito);
_ Para un buen uso de este convertidor siempre será necesario aplicar una fuente Bus Dali (ref. 201281.1010 e 20981.1010).

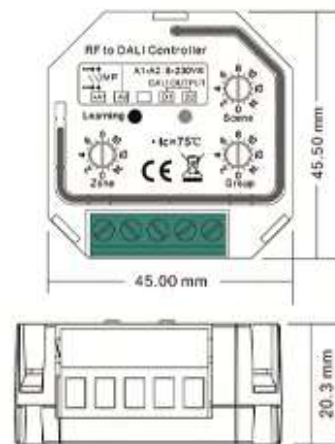

NOTA:

Funciona com o comando 213219.DIM4
Funciona con el mando 213219.DIM4

Este controlador necessita de fonte Dali e é alimentado pelo BUS Dali.
Este controlador necesita una fuente Dali y se alimenta mediante el BUS Dali.

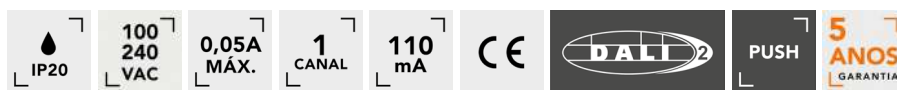

REF. 2112270.DA

_ Controlo por botão Push convencional, com ou sem memória;
_ Velocidade de escurecimento ajustável por botão rotativo.

_ Controlo por botão Push convencional, com ou sem memória;
_ Velocidade de escurecimento ajustável por botão rotativo.

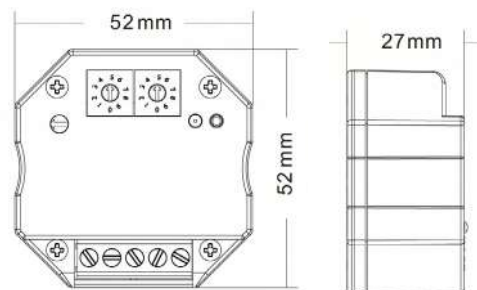

Fonte BUS Dali
Fuente BUS Dali

REF. 2032881.64DA

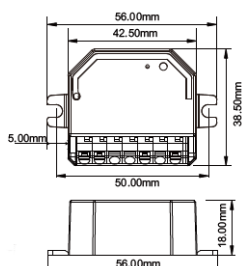

Fontes para alimentação do BUS DALI
Fuentes para Alimentación do BUS DALI

REF. 201281.1010



REF. 20981.1010



SENSOR DE PRESENÇA E CREPUSCULAR DALI ENCASTRAR EM TETO

SENSOR DALI DE PRESENCIA Y CREPUSCULAR EMPOTRAR EN TECHO



REF. 2232265

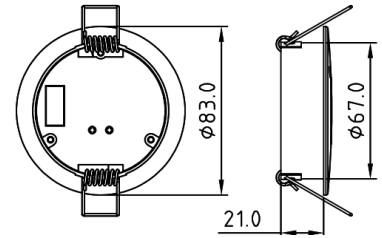

COMANDO TOUCH CONTROL TEMPERATURA DE COR DALI DT8

MANDO TOUCH CONTROL TEMPERATURA DE COLOR DALI DT8



REF. 2110752.CCT



_Sensível ao toque; Interface de vidro. Controla 4 grupos DALI e 2 cenas DALI. Suporta dispositivos DT8. Ajuste de temperatura de cor de acordo com DALI especificações do tipo de dispositivo 8, tipo de cor Tc. Cada dispositivo DT8 é controlado por meio de um único endereço DALI.

_Sensible al tacto. Interfaz de vidrio. Controla 4 grupos DALI y 2 escenas DALI. Admite dispositivos DT8. Ajuste de la temperatura de color según las especificaciones del tipo de dispositivo DALI 8, tipo Color Tc. Cada dispositivo DT8 se controla a través de una sola dirección DALI.

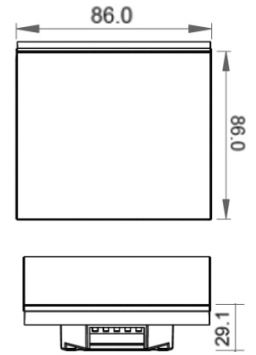

CONTROLADOR CCT 12-36VDC 4X5A 480W-24VDC DALI DT8

CONTROLADOR CCT 12-36VDC 4X5A 480W-24VDC DALI DT8



REF. 2110252.5480

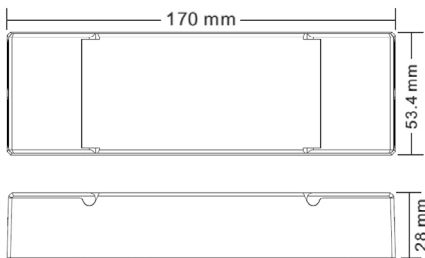

_Dispositivo DALI DT8 para controlar temperaturas de cor em brancos entre quente e frio, através de um único endereço DALI. Controlo de cores conforme definido no dispositivo de especificação DALI DT8;
 _Suporta comandos de dispositivo DT8, compatível com mestres DALI que suportam comandos DT8;
 _Display digital numérico para definir o endereço DALI manualmente;
 _Este controlador permite funcionar com DALI 2 tipo DT8, igual para sistema Human Centric Light.

_Dispositivo DALI DT8 para controlar temperaturas de color en blancos entre cálidos y fríos, a través de una única dirección DALI. Control de color como se define en el dispositivo de especificación DALI DT8;
 _Soporta DT8 eevce mandos, compatible con maestros DALI que soportan DT8 mandos;
 _Pantalla digital numérica para configurar la dirección DALI manualmente. Este controlador permite trabajar con DALI 2 tipo DT8, lo mismo para el sistema Human Centric Light.

COMANDO ROTATIVO DALI MASTER + WIFI

COMANDO ROTATIVO DALI MASTER + WIFI



REF. 2110779.2DA

_Painel WiFi & RF DALI Master para 1-5 cores, compatível com controlo de dimming, temperatura de cor, RGB, RGBW e RGB+CCT.

_Panel WiFi y RF DALI Master para 1-5 colores, compatible con control de regulación, temperatura de color, RGB, RGBW y RGB+CCT.



CONTROLADOR DIMMER CONTROLADOR REGULABLE



REF. 215218.4120

Controlador Dimmer 1 Canal 10A Dali-Push
Controlador Regulable 1 Canal 10A Dali-Push

_Este controlador permite ser controlado por DALI e PUSH. Ideal para soluções de controlo de luminosidade em sistemas domóticos com protocolo de comunicação DALI.

_Este controlador puede ser controlado por DALI y PUSH. Ideal para soluciones de control de iluminación en sistemas domóticos con protocolo de comunicación DALI.

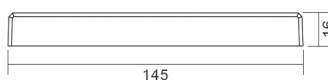

CONTROLADOR RGB CONTROLADOR RGB



REF. 2126218.5480

Controlador RGB+W DALI DT8

_Controlador RGB+W Dali DT8 com Auto Detection do sistema de controlo (RGB+W ou XY). Sistema Auto Detection para canal Dali. Ecrã endereçável do canal Dali através de 2 switch.

_Controlador Dali DT8 RGB+W con Auto Detección del sistema de control (RGB+W o XY). Sistema de Auto Detección para canal Dali. Pantalla direccionable de canal Dali a través de 2 interruptores.

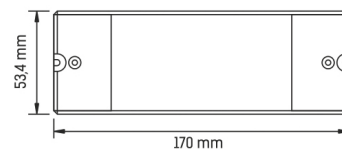

REF. 2126228.5600

Controlador RGB+W+WW DALI DT8

_Controlador RGB+W+WW Dali DT8 com Auto Detection do sistema de controlo (RGB+W ou XY). Sistema Auto Detection para canal Dali. Ecrã endereçável do canal Dali através de 2 switch.

_Controlador Dali DT8 RGB+W+WW con Auto Detección del sistema de control (RGB+W o XY). Sistema de Auto Detección para canal Dali. Pantalla direccionable de canal Dali a través de 2 interruptores.

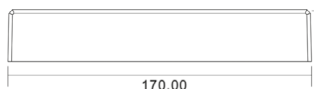

CONTROLADORES DIMMER

CONTROLADORES DIMMER TRIAC
CONTROLADORES REGULABLES TRIAC

IP20
230V
PL
HALOG. 400W
LED 200W
1 CANAL
CE
DALI
PUSH
TRIAC



REF. 2112248.3400 Conversor Dimmer PUSH / DALI-TRIAC
Conversor Regulable PUSH / DALI-TRIAC

- _ Um endereço DALI para controlar uma saída de canal, até 400W;
- _ Função inovadora de configuração de brilho mínimo;
- _ Compatibilidade com interruptores de pressão de entrada universais 8V-230V.
- _ Una dirección DALI para controlar salida de un canal, hasta 400W;
- _ Innovadora función de ajuste de brillo mínimo;
- _ Gran compatibilidad con presostatos universales de entrada 8V-230V.

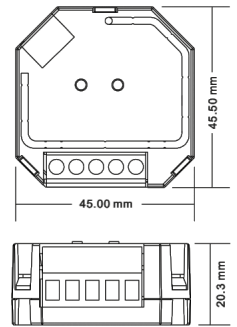

SUGESTÕES | SUGERENCIAS

Filtro de Proteção 230Vac 480W Triac
Filtro de Protección
Ref. 2238280.3480



IP20
100 240 VAC
PL
460W
2 CANAIS
2A CANAL
CE
DALI
TRIAC



REF. 2110226.3576 Controlador Dimmer Dali Triac
Controlador Regulable Dali Triac

- _ Este é um controlador dimmer com entrada DALI e saída TRIAC;
- _ Ideal para aplicações de instalações com gestão integrada onde permite controlar lâmpadas ou outros componentes através de DALI;
- _ Auto detection de canal DALI, display para control de canal de entrada DALI.

- _ Este es un controlador ajustable con entrada salida DALI y TRIAC;
- _ Ideal para aplicaciones de instalación con gestión integrada donde puede controlar lámparas u otros componentes a través de DALI;
- _ Detección automática de canal DALI, pantalla para control de canal de entrada DALI.

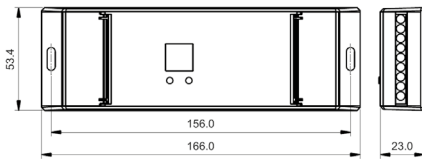

IP20
12-48 VDC
PL
1 CANAL
20A CANAL
CE
DALI
PUSH
TRIAC
0/1-10V

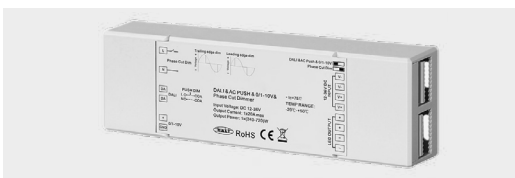

REF. 2124218.5480

Controlador Dimmer DALI + AC Push + 0/1-10 + Triac
Controlador Regulable DALI + AC Push + 0/1-10 + Triac

- _ Compatível com todos os sistemas DALI do mercado;
- _ Um endereço DALI atribuído pelo mestre DALI;
- _ Compatível com dimmers de corte de fase universal;
- _ Para trabalhar com repetidor de potência para expandir a potência de saída ilimitadamente.

- _ Compatible con todos los sistemas DALI del mercado;
- _ Una dirección DALI asignada por el maestro DALI;
- _ Compatible con ajustadores de corte de fase universales;
- _ Para trabajar con el repetidor de potencia para expandir la potencia de salida ilimitadamente.

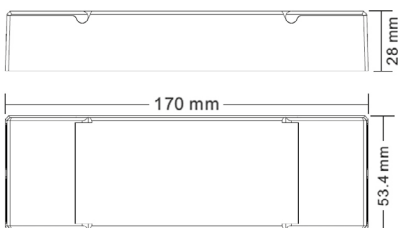

CONVERSORES

CONTROLADOR DALI ON/OFF
CONTROLADOR DALI ON/OFF

IP20
230V
PL

1 CANAL
5A
CE
REF. 2112252.31000

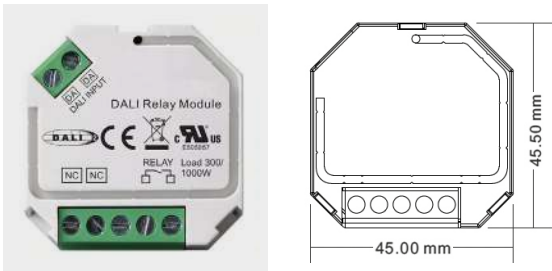

CONTROLADOR DALI ON/OFF
CONTROLADOR DALI ON/OFF

IP20
100 240VAC
PL

4 CANAIS
12A CANAL
CE
REF. 2112213.32760

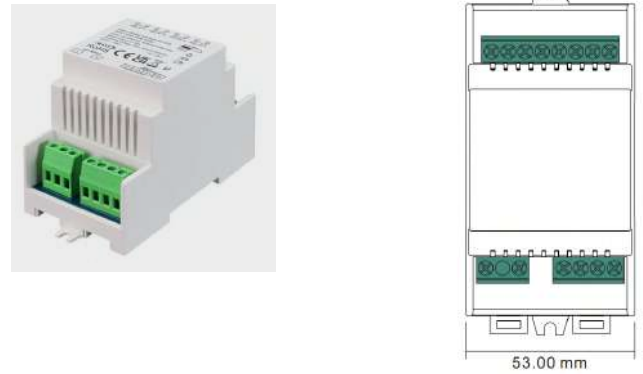

CONTROLADOR DALI / 0/1-10V ON/OFF
CONTROLADOR DALI / 0/1-10V ON/OFF

100 240 VAC
IP20
PL
OUT 0/1 - 10V
1 CANAL
5A
CE
0/1-10V

5 ANOS GARANTIA



REF. 2112252.3100 **Conversor DALI - 0/1-10V Relé ON/OFF**
Convertidor DALI - 0/1-10V Relé ON/OFF

_Relé On/Off com comando de Dali. Este conversor ativa um relé de 240V 5A através de um comando Dali. Poderá converter uma entrada Dali numa saída 0/1-10V. Conversor ideal para instalar numa linha Bus-Dali.

_Relé On/Off con comando Dali. Este convertidor activa un relé de 240V 5A a través de un Dali mando. Puede convertir una entrada Dali en una salida 0/1-10V. Convertidor ideal para instalar en una línea Bus-Dali.

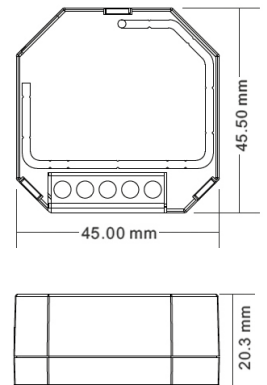

_In: DALI
_Out: 0/1-10V

CONVERSOR PUSH - 0/1-10V
CONVERTIDOR PUSH - 0/1-10V

85-265 VDC
IP20
OUT 0/1 - 10V
1 CANAL
1,05A
CE
PUSH
0/1-10V



REF. 2118237 **Conversor PUSH + RF - 0/1-10V**
Convertidor PUSH + RF - 0/1-10V

_Conversor Push+RF que convierte un botón de presión e/ou RF num sinal de 0-10V ou 1-10V. Conversor ideal para controlar drivers de 0-10V e 1-10V através de botão de pressão e/ou RF.

_Convertidor Push+RF que convierte un pulsador y/o señal RF en una señal 0-10V o 1-10V. Convertidor ideal para controlar drivers 0-10V y 1-10V vía pulsador y/o RF.

Funciona com os comandos 2120244.DIM, 2120244.DIM4 e 2121244.DIM.
Funciona con los mandos 2120244.DIM, 2120244.DIM4 y 2121244.DIM

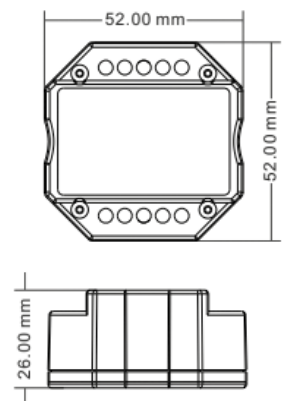

_In: PUSH+RF
_Out: 0/1-10V

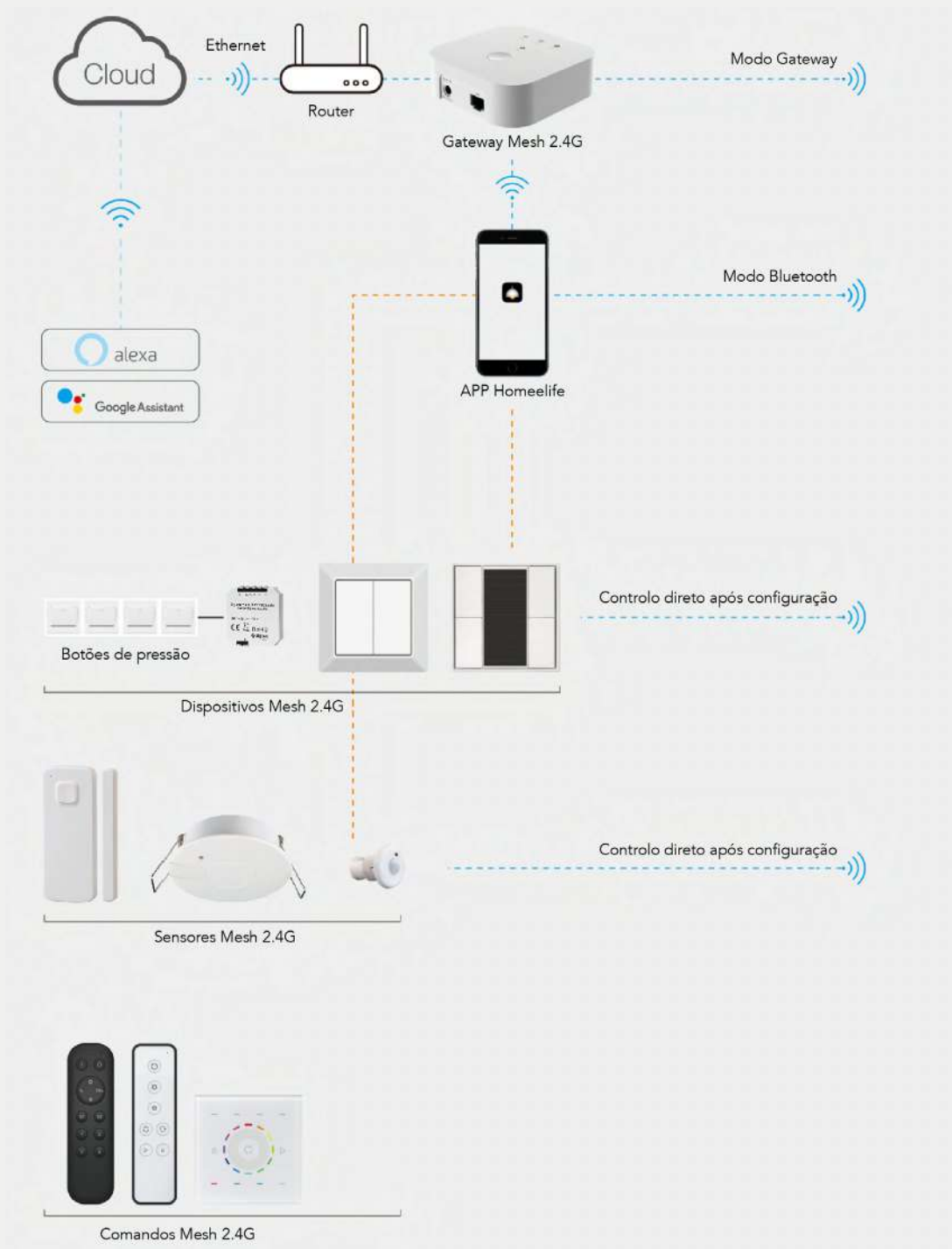

A série RF Mesh 2.4G combina os benefícios do control RF, controlo por APP e rede mesh sem gateway. Neste novo sistema Mesh 2.4G estão integrados dispositivos de iluminação, persianas, sensores de movimento e de luz, sensores de janela/porta. O controle através da cloud permite que possa controlar a sua casa mesmo quando se encontra ausente. O controlo de voz através do Amazon Alexa, Google Home e Yandex Alic é outra característica importante deste novo sistema.

La serie 2.4G RF Mesh combina los beneficios del control de RF, el control de aplicaciones y la red de malla sin puerta de enlace. En este nuevo sistema Mesh 2.4G se integran dispositivos de iluminación, persianas, sensores de movimiento y luz, sensores de ventanas/puertas. El control a través de la nube te permite controlar tu hogar incluso cuando estás fuera. El control por voz a través de Amazon Alexa, Google Home y Yandex Alic es otra característica importante de este nuevo sistema.



HOMELIFE

Google Play



App Store



MESH 2.4G

Smart Home

CONTROLORES DIMMER
CONTROLORES REGULABLES



REF. 2131218.6192 Controlador Push DIM

- _ Controlado através de aplicativos inteligentes e controles remotos, sem necessidade de gateway
- _ Emparelhamento fácil e rápido com o aplicativo inteligente apenas pressionando o botão de programação
- _ Compatível com controles remotos Mesh universais 2.4G, cada controlador LED pode emparelhar no máximo 8 controles remotos
- _ Controlado a través de aplicaciones inteligentes y controles remotos, no se requiere puerta de enlace
- _ Emparejamiento fácil y rápido con la aplicación inteligente con solo presionar el botón de programación
- _ Compatible con controles remotos universales Mesh 2.4G, cada controlador LED puede emparejar un máximo de 8 controles remotos

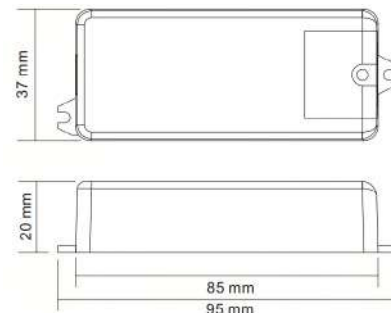

REF. 2131224.4384 Controlador DIM, CCT, RGBW, RGB+CCT

- _ Permite controlar ON/OFF, intensidade da luz, temperatura da cor
- _ Distância de transmissão de até 30 m entre cada dois dispositivos na proximidade
- _ Le permite controlar ON/OFF, intensidad de luz, temperatura de color
- _ Distancia de transmisión de hasta 30 m entre cada dos dispositivos cercanos

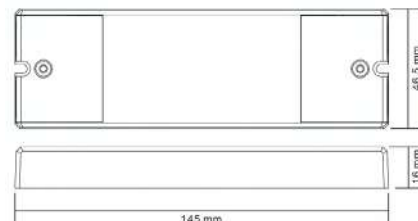

REF. 2131248.3400 Controlador Push DIM 230V s/ Neutro 200W

- _ Dimmer RF+Bluetooth micro inteligente
- _ Pode operar sob conexão de dois fios sem fio neutro ou conexão de três fios, com fio neutro. Permite controlar ON/OFF e intensidade de luz. Com memória do último nível de iluminação utilizado.
- _ Atenuador inteligente micro RF+Bluetooth
- _ Puede funcionar con conexión de dos hilos sin neutro o con conexión de tres hilos, con neutro. Le permite controlar el encendido/apagado y la intensidad de la luz. Con memoria del último nivel de iluminación utilizado.

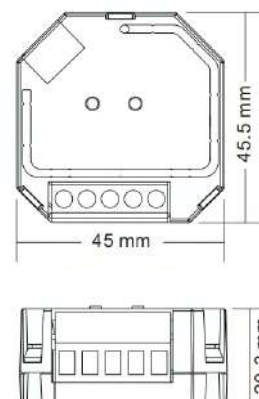

SUGESTÕES | SUGERENCIAS

Filtro de Proteção
230Vac 480W Triac
Filtro de Protección
Ref. 2238280.3480

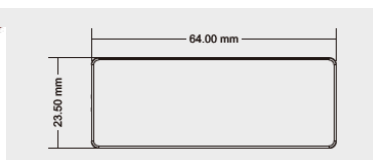

CONTROADOR ON/OFF



REF. 2131213.31000 Controlador ON/OFF Push s/ neutro



- _ Pode operar sob conexão de dois fios sem fio neutro ou conexão de três fios, com fio neutro
- _ 1 saída de canal, máx. carregar até 4,8A
- _ Puede funcionar con conexión de dos hilos sin neutro o con conexión de tres hilos, con neutro
- _ Salida de 1 canal, máx. carga hasta 4.8A

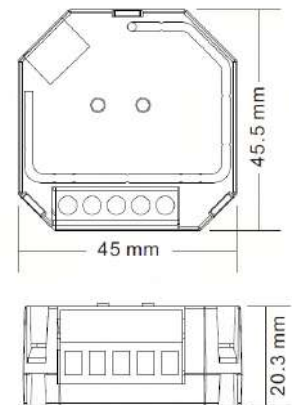

CONTROADOR DE ESTORES

CONTROADOR DE PERSIANAS



REF. 2131253.3920 Controlador de Estores Push 240Vac
Controlador de Persianas Push 240Vac



- _ Controlado por aplicativo inteligente ou diretamente por RF
- _ Controlo local com interruptores externos, mesmo que não esteja emparelhado com um smartphone
- _ Suporta ON/OFF e controle de níveis
- _ Emparelhamento fácil e rápido com o aplicativo inteligente apenas pressionando o botão K2
- _ Pode ser controlado por interruptores ON/OFF externos
- _ Controlado por aplicación inteligente o directamente por RF
- _ Control local con interruptores externos, incluso si no está emparejado con un teléfono inteligente
- _ Admite encendido/apagado y control de nivel.
- _ Emparejamiento fácil y rápido con la aplicación inteligente con solo presionar el botón K2
- _ Puede ser controlado por interruptores externos ON/OFF

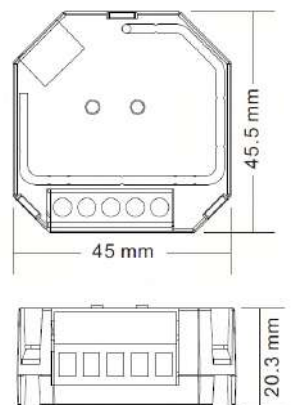

CONVERSOR MESH 2.46-DALI/0-10V

CONVERTIDOR MESH 2.46-DALI/0-4V



REF. 2131231



- _ O dispositivo DALI controlado pode ser DT6 ou DT8
- _ Para control: RGB+CCT, RGBW, RGB, CCT, DIM, ON/OFF usando a APP
- _ Seleção de qualquer Grupo DALI (0-15) ou Endereço DALI (00-63) para controlar por interruptores rotativos
- _ Cada linha DALI pode instalar vários controladores para vários pontos de controle
- _ El dispositivo DALI controlado puede ser DT6 o DT8
- _ Para control: RGB+CCT, RGBW, RGB, CCT, DIM, ON/OFF mediante APP
- _ Selección de cualquier grupo DALI (0-15) o dirección DALI (00-63) para controlar mediante interruptores giratorios
- _ Cada línea DALI puede instalar múltiples controladores para múltiples puntos de control

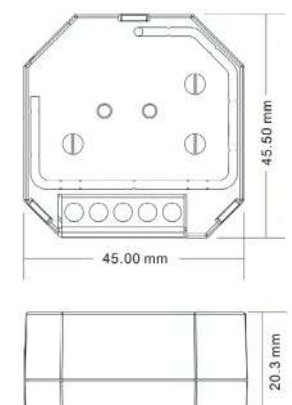

— MÓDULO DE 4 ENTRADAS



REF. 2131272

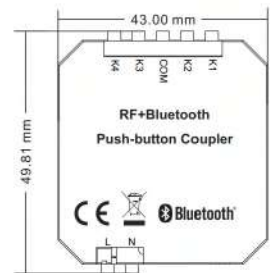
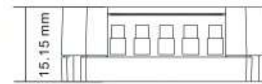

— AMPLIFICADOR DE SINAL AMPLIFICADOR DE SEÑAL



REF. 213126



- _ Amplificador para dispositivos RF+Bluetooth.
- _ Antena dupla para maior alcance.
- _ Plug and play, sem necessidade de ser adicionado à rede Bluetooth.
- _ Alcance de 30m em espaço aberto
- _ Amplificador para dispositivos RF+Bluetooth.
- _ Antena dual para mayor alcance.
- _ Plug and play, no es necesario agregarlo a la red Bluetooth.
- _ Alcance de 30 m en espacio abierto

— GATEWAY ETHERNET



REF. 2131273



- _ O HUB inteligente é usado para conectar os dispositivos à Cloud
- _ Controlo da cloud, suporta controle de voz através do Amazon Alexa e Assistente Google.
- _ Modelo RTC integrado, pode manter o relógio a funcionar mesmo em caso de falha de energia
- _ El HUB inteligente se utiliza para conectar dispositivos a la Nube
- _ Control en la nube, admite control por voz a través de Amazon Alexa y Google Assistant.
- _ Modelo RTC integrado, puede mantener el reloj funcionando incluso en caso de corte de energía

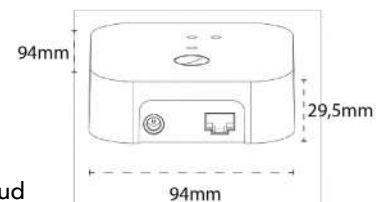

COMANDOS MESH 2.4G

MANDOS MESH 2.4G



REF. 213123.DIM4

Comando DIM Cor Única 4 zonas.
Equipamento funciona com pilha.
Mando DIM Monocolor 4 zonas.
Funciona con batería.

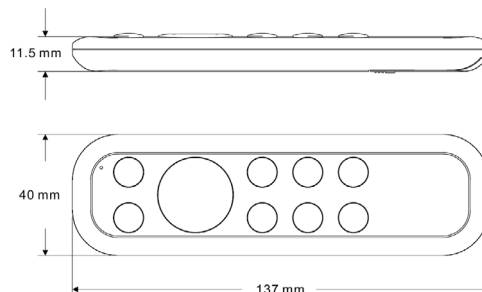

REF. 213262.RGBWW+W

Comando TOUCH RGB+WW+W 4 zonas.
Equipamento funciona com pilha.
Mando TOUCH RGB+WW+W 3 zonas.
Funciona con batería.

_ Cada controlo remoto pode controlar vários recetores. Cada recetor pode ser emparelhado no máximo 8 controlos remotos. O status do recetor controlado pode ser rapidamente sincronizado com a APP
_Permite vincular e controlar dispositivos universais de cor única

_ Cada mando a distancia puede controlar varios receptores. Cada receptor se puede emparejar con un máximo de 8 mandos a distancia. El estado del receptor controlado se puede sincronizar rápidamente con la APP
_Permite vincular y controlar dispositivos universales de un solo color

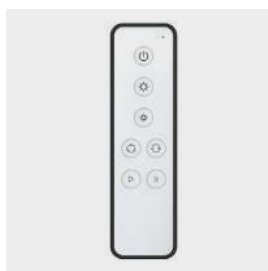

REF. 213262.DIM3

Comando Touch Dim Cor Única 4 zonas
Equipamento funciona com pilha.
Mando Touch DIM Monocolor 4 zonas
Funciona con batería.

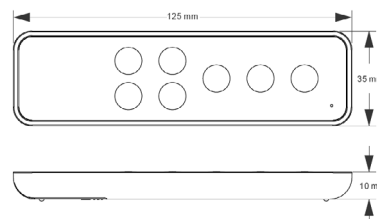

HOME AUTOMATION

WE CONTROL

NEXTA
TECH

DIMMER 230V
REGULABLE 230V



CONTROLADOR
DALI

CONTROLO DE ESTORES
CONTROL DE PERSIANAS



COMANDO RGB+W+WW
MANDO RGB+W+WW

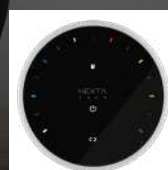

FIO INTEGRADO + RF + WIFI + CONTROLE VOCAL

Os controladores OneSmart são feitos para serem gerenciados por botões de pressão com fio, controles de rádio e seu aplicativo para smartphone. Graças à nossa infra-estrutura de Cloud é possível comunicar-se com os dispositivos de qualquer parte do mundo. Não é necessário instalar nenhum gateway, basta ter a rede de internet WiFi de 2,4 GHz, o suficiente para configurar qualquer controlador em poucos minutos.

CABLE INTEGRADO + RF + WIFI + CONTROL DE VOZ

Los controladores OneSmart están hechos para ser administrados por botones pulsadores con cable, controles de radio y la aplicación de su teléfono inteligente. Gracias a nuestra infraestructura en la Nube, es posible comunicarse con dispositivos de cualquier parte del mundo. No es necesario instalar ninguna puerta de enlace, basta con disponer de la red de internet WiFi de 2,4 GHz, suficiente para configurar cualquier controlador en pocos minutos.

SENSOR DE MOVIMENTO
SENSOR DE MOVIMIENTO



SENSOR DE PORTA
SENSOR DE PUERTA



SENSOR DE GAVETAS
SENSOR DE CAJONES



1



Conecte os dispositivos de alcance ONESMART e conecte-os ao router via WIFI

Conecta dispositivos de la gama ONESMART y conéctalos al router vía WIFI

2



Conecte o MCU-SCENARIO a um ou dois botões na parede e conecte-o ao router via WIFI

Conecte el MCUSCENARIO a uno o dos botones en la pared y conéctelo al router vía WIFI

3



Crie cenários e automatismos com a aplicação ONESMART

Creas escenarios y automatizaciones con la aplicación ONESMART

4

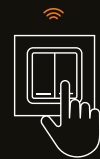

Ative cenas através dos botões de parede ligados à aplicação MCU-SCENARIO

Activa escenas mediante los botones de pared conectados a la aplicación MCU-SCENARIO

CONTROLADOR ON/OFF 230V

CONTROLADOR ON/OFF 230V

REF. 2127254.3400 _Wifi 2,4GHz

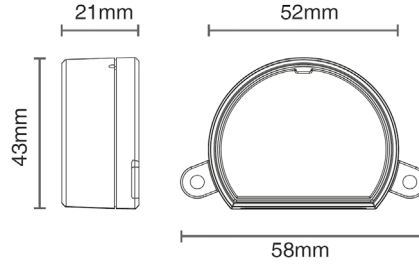

REF. 2127254.3300 _Wifi 2,4GHz;
_Este controlador permite 3000W/canal, mas a potência total não deverá superar os 6000W.

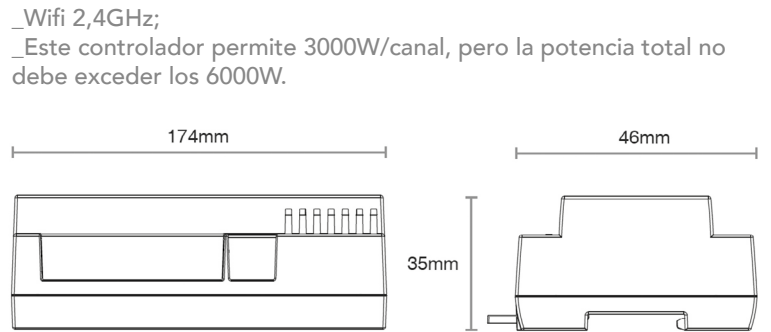

CONTROLADORES DIMMER

CONTROLADORES REGULABLE

REF. 2127258.3150 Dimmer 230V
Regulable 230V

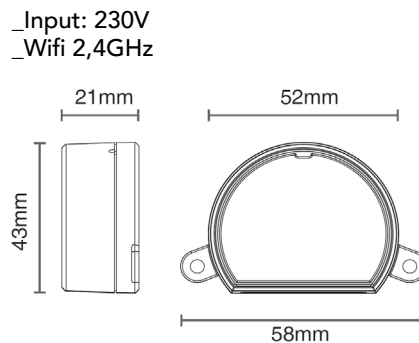

CONTROLORES DIMMER

CONTROLORES REGULABLES



Controlador 1 Canal 5A
Controlador Canal 5A

REF. 2127258.4120

IP20 12-24 VDC RF 1 CANAL 5A CANAL CE



Controlador 4 Canais 10A | 4x Dim individual *
Controlador 4 Canales 10A* | 4x Dim individual *

REF. 2127268.4120

IP20 12-24 VDC RF 4 CANAIS 5A CANAL CE PUSH

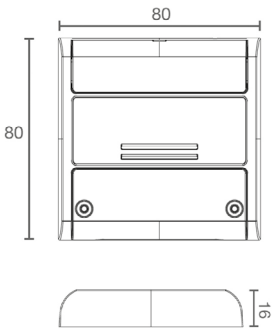

Controlador 4 Canais 10A | 4x Dim individual *
Controlador 4 Canales 10A* | 4x Dim individual *

REF. 2127218.4240

IP20 12-24 VDC RF WIFI 4 CANAIS 5A CANAL CE PUSH

Controlador 4 Canais 10A | 1x Dim / 1x CCT / 1x RGB / 1x RGBW *
Controlador 4 Canales 10A | 1x Dim / 1x CCT / 1x RGB / 1x RGBW *

REF. 2127258.4240

IP20 12-24 VDC RF WIFI 4 CANAIS 5A CANAL CE PUSH

*Estes controladores permitem 5A/canal, mas a potência total não deverá superar os 10A.
*Estos controladores permiten 5A/canal, pero la potencia total no debe exceder los 10A.

CONTROLORES DIMMER

CONTROLORES REGULABLES



REF. 2127258.0110 **Dimmer 0/1-10V**
Regulable 0/1-10V

IP20 RF WIFI OUT 2000K CE PUSH 0/1-10V Input: 230V Wifi 2,4GHz

REF. 2127258.DA20 **Dimmer DALI**
Regulable DALI

IP20 RF WIFI CE DALI PUSH Input: 230V Wifi 2,4GHz Máximo: 20 Drivers

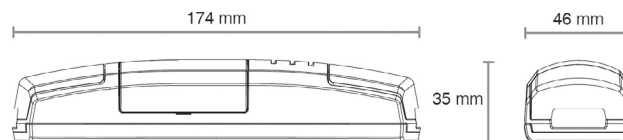

CONTROLOADORES DE MOTORES

CONTROLOADORES DE MOTORES



REF. 2127254.PORT

Controlador de Portões
Controlador de Portones



- _Wifi 2,4GHz
- _Por NO, impulso

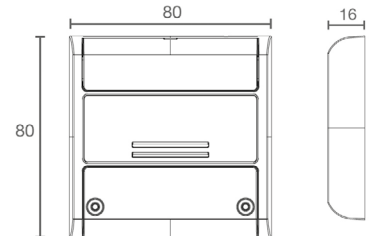

REF. 2127257.3500

Controlador de Estores
Controlador de Persianas

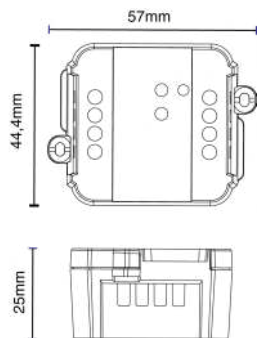

_Wifi 2,4GHz



REF. 2127257.32000

Controlador de Estores
Controlador de Persianas

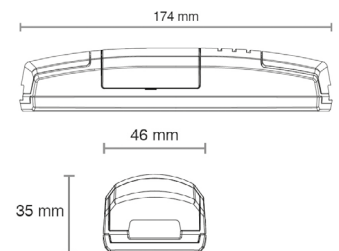

_Wifi 2,4GHz

CONTROLOADOR DE ESTORES

CONTROLOADOR DE PERSIANAS

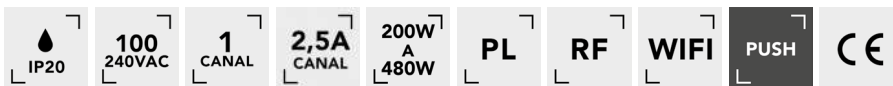

REF. 2130253.3480

Controlador Estores 230V RF+WIFI+PUSH
Convertidor de Persianas 230V RF +WiFi+PUSH



- _Funciona por percentagem: permite escolher a percentagem de abertura dos estores
- _Adaptável a calha DIN
- _Funciona por wifi doméstica, com a APP Smart Life e Tuya
- _Controlo de voz através da Alexa e Google.
- _Funciona por porcentaje: permite elegir el porcentaje de abriendo las persianas
- _Adaptable a carril DIN
- _Funciona mediante WiFi de casa, con la APP Smart Life y Tuya
- _Control por voz a través de Alexa y Google.

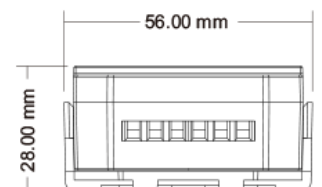
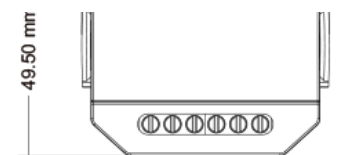

- _Funciona com o comando da serie ECO 2120244.DIM
- _Funciona con el control de la serie ECO 2120244.DIM

COMANDOS RF
MANDOS RF

REF. 2127261.4DIM



Com Bateria
Con Bateria

_4 Zonas
 _ON/OFF, DIM
 _4 Zonas
 _ON/OFF, DIM

REF. 2127261.4RGB



Com Bateria
Con Bateria

_4 Zonas
 _RGB/RGBW, DIM, CCT
 _4 Zonas
 _RGB/RGBW, DIM, CCT

REF. 2127261.30



Com Bateria
Con Bateria

_30 Zonas
 _RGB / RGBW / CCT / DIM / Estores
 _30 Zonas
 _RGB / RGBW / CCT / DIM / Persianas

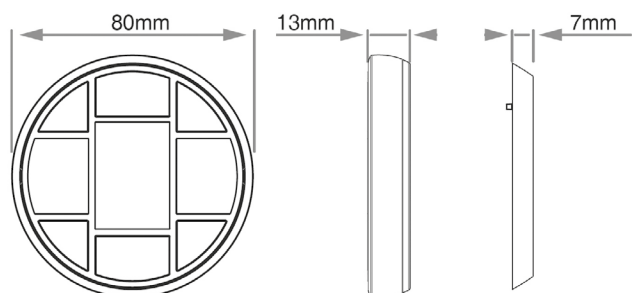

COMANDOS TOUCH PORTÁTIL

MANDOS TOUCH PORTÁTIL

REF. 2127261.4

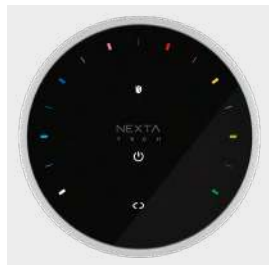

_6 Zonas
_RGBW / CCT / DIM

_6 Zonas
_RGBW / CCT / DIM

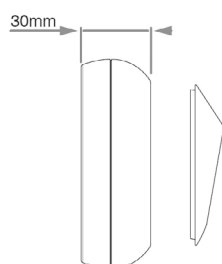
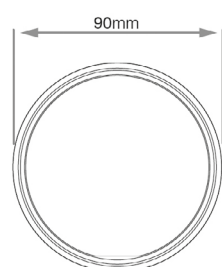

Comando à distância multicanal ideal para controlar estores, persianas e leds dimáveis e RGB. Combinado com os controladores de iluminação, graças ao brilho dos LEDs RGB, a intensidade da luz pode ser facilmente reduzida e a tonalidade da cor e a temperatura da luz branca controlada.

Fornecido com um suporte de parede ou mesa com contato magnético, é equipado com um acelerômetro que permite que o controlador ligue instantaneamente quando levantado ou movido.

Mando a distancia multicanal ideal para controlar persianas regulables y RGB, estores y LEDs. Combinado con los controladores de iluminación, gracias a la luminosidad de los LEDs RGB, se puede reducir fácilmente la intensidad de la luz y controlar el tono de color y la temperatura de la luz blanca.

Suministrado con un soporte de pared o de mesa con contacto magnético, está equipado con un acelerómetro que permite que el controlador se encienda instantáneamente cuando se levanta o se mueve.

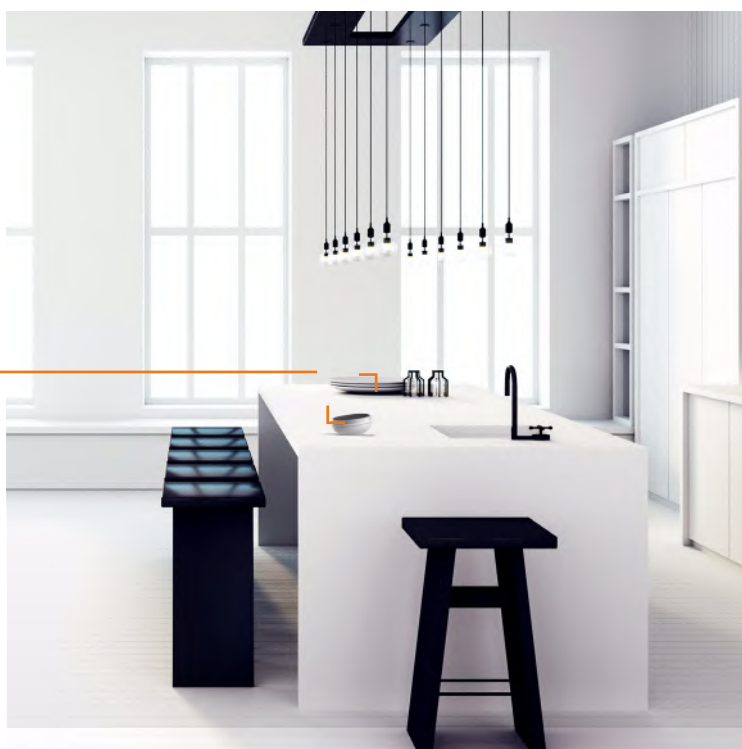

COMANDOS SLIM DE PAREDE

MANDOS SLIM DE PARED



REF. 2127260.2



_Com 2 botões
_Con 2 botones

REF. 2127260.4



_Com 4 botões
_Con 4 botones

REF. 2127260.8



_Com 8 botões
_Con 8 botones

REF. 2127260.DIM1



_Dimmer
_1 Canal | 1 Zona
_On/Off
_Regulable
_1 Canal | 1 Zona
_On/Off

REF. 2127260.RGBW1



_RGB / RGBW
_4 Canais | 1 Zona
_RGB / RGBW
_4 Canales | 1 Zona

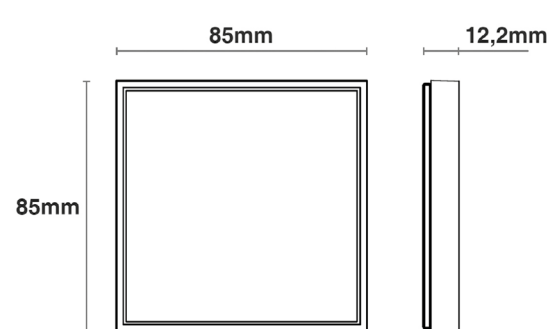

_Design minimalista e elegante para uma integração perfeita em qualquer ambiente, é construído com botões mecânicos resistentes que podem ser ativados pressionando qualquer ponto de sua área;

_Alcance: 80m em espaços abertos (30m em espaços fechados).

_Diseño minimalista y elegante para una perfecta integración en cualquier entorno, está construido con resistente botones mecánicos que se activan pulsando cualquier punto de su zona;

_Alcance: 80m en espacios abiertos (30m en espacios cerrados).

MINI COMANDOS RF

MINI MANDOS RF



<p>REF. 2127262.1</p> <p>_1 Zona _Dimável On/Off _1 Zona _Regulable On/Off</p>	<p>REF. 2127262.1ES</p> <p>_1 Zona _Dimável On/Off _Controlo de estores _1 Zona _Regulable On/Off _Control de persianas</p>	<p>REF. 2127259.1</p> <p>_1 Zona _Dimável On/Off _1 Zona _Regulable On/Off</p>	<p>REF. 2127259.1RGBW</p> <p>_1 Zona _Dimável On/Off e Seleção de cores _1 Zona _Regulable On/Off y Selección de Colores</p>
<p>REF. 2127263.1</p> <p>_Programável _1 Zona _Programable _1 Zona</p>	<p>REF. 2127263.3</p> <p>_Programável _2 Zonas _Programable _2 Zonas</p>	<p>REF. 2127263.4</p> <p>_Programável _4 Zonas _Programable _4 Zonas</p>	<p>REF. 2127259.1CCT</p> <p>_1 Zona _Regulação de temperatura de cor _1 Zona _Regulación de temperatura de color</p>

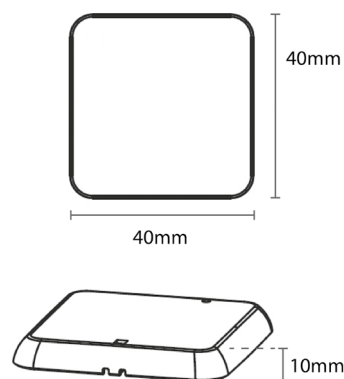

Tecnologia Touch | Tecnología Touch

- _Botão central táctil e roda táctil para envio de comandos através do movimento rotativo;
- _Ideal para escurecimento de ações.
- _Botón táctil central y rueda táctil para el envío de comandos a través del movimiento giratorio;
- _Ideal para acciones de oscurecimiento.

SENSOR TOUCH RF

SENSOR TOUCH RF



Com Bateria
Con Bateria

De encastrar*
Empotrado*

REF.2127264.TOUCH

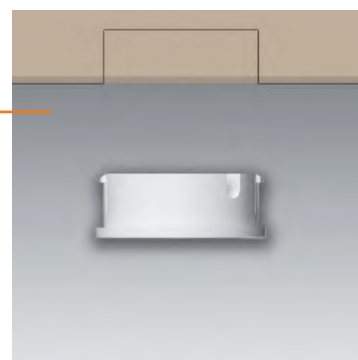
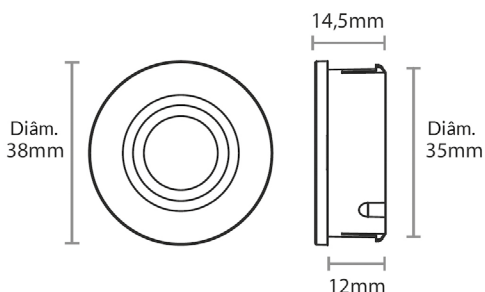

SENSOR DE MOVIMENTO RF

SENSOR DE MOVIMIENTO RF



Com Bateria
Con Bateria

De encastrar*
Empotrado*

REF. 2127264.MOVE



_ Dimmer
_ On/Off
_ Alcance: 40m em espaços abertos
(15m em espaços fechados)

_ Regulable
_ On/Off
_ Alcance: 40m en espacios abiertos
(15m en espacios cerrados)

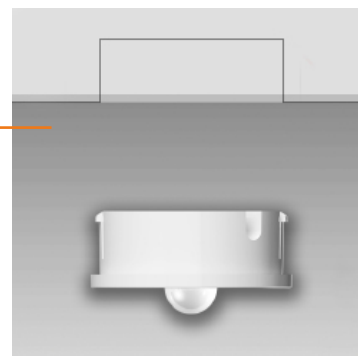
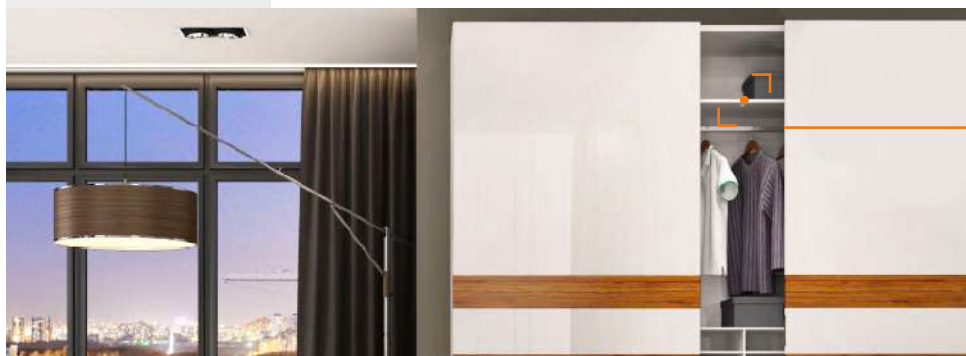
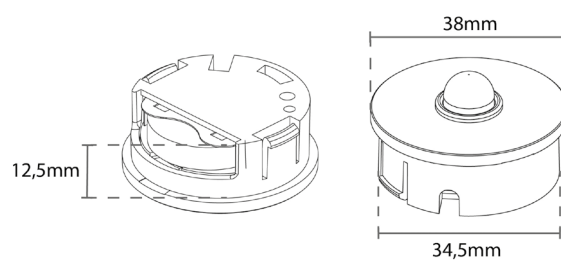

* Disponível na versão saliente

* Versión de superficie también disponible

SENSOR DE MOVIMENTO RF

SENSOR DE MOVIMIENTO RF



Sensor Gaveta
Sensor Cajon

Com Bateria
Con Bateria

De encastrar*
Empotrado*

REF. 2127265.PORTA

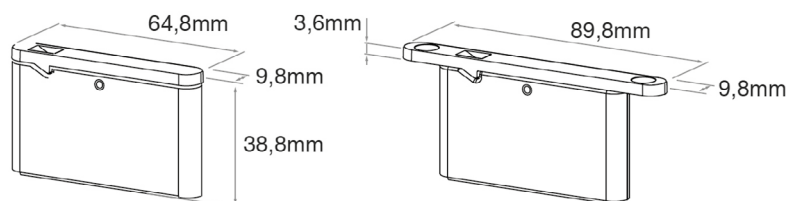

Sensor Porta
Sensor Puerta

Com Bateria
Con Bateria

De encastrar*
Empotrado*

REF. 2127264.PORTA

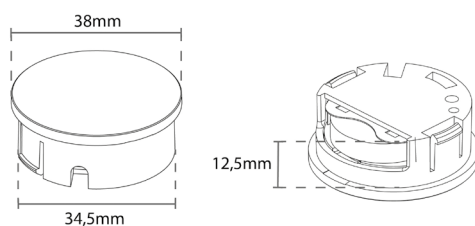

* Disponível na versão saliente

* Versión de superficie también disponible

CONTROADORES DE CENÁRIOS

CONTROADORES DE ESCENARIOS



REF. 2127255.2

Controlador 2 cenários
Controlador 2 escenarios



_Gestão de controlo remoto de cenários por botão de pressão.
_Gestión por control remoto de escenarios de pulsadores

_Input: 230V
_Wifi 2,4GHz

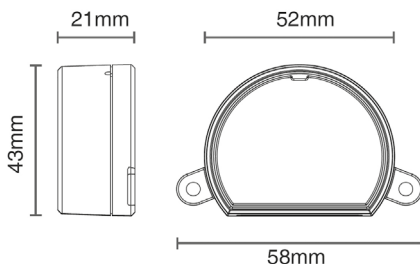

REF. 2127255.8

Controlador 8 cenários
Controlador 8 escenarios



_Gestão de cenários por comando RF Nexta.
_Gestión de escenarios por mando RF Nexta.

_Input: 230V
_Wifi 2,4GHz

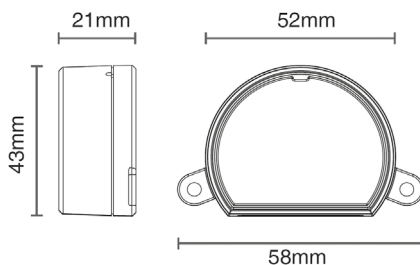

COMANDO RF

MANDO RF



Com Bateria
Con Bateria

REF. 2127255.4FIO

Comando 4 entradas
Mando 4 entradas



_Conexão sem fios, rápida e fiável
_ Transforme os botões da sua casa em comandos RF

_Conexión sin hilos rápido y confiable
_Convierta sus botones en mandos RF





 **zigbee**

 **matter**

COMPATÍVEL
COMPATIBLE

- Amazon Alexa Echo Plus
- Philips Hue Bridge
- Apple Home Kit
- Legrand Netatmo

(terá que ter uma Alexa como ponte)

(habrá que tener una Alexa como puente)



SMART HUB AZOULA Compatibilidades



GATEWAY ZIGBEE

REF. 2231252

Azoula



Azoula Smart Hub



SUPORTA 150 DISPOSITIVOS ZIGBEE

Conecte mais dispositivos por meio da fusão de várias gateways



Ritmo circadiano



Monitorização de Energia



Controlo local e da Cloud



Android / iOS



Diversas configurações de iluminação



Seguro e sem delays



Fusão de várias Gateways



Compatível com Amazon Alexa Google Home



AZOULA
Smart Hub

DIMMER / CONTROLADOR RGB+W+WW / CCT (ECO)

IP20
 12-48 VDC
 PL
 5x144W
 5 CANAIS
 6A CANAL
 CE
 3 ANOS GARANTIA



REF. 2122246.6720

_Contém 5 modos de dispositivos diferentes DIM, RGB, RGBW, CCT e RGB+CCT.

_Contiene 5 modos de dispositivo diferentes DIM, RGB, RGBW, CCT y RGB+CCT

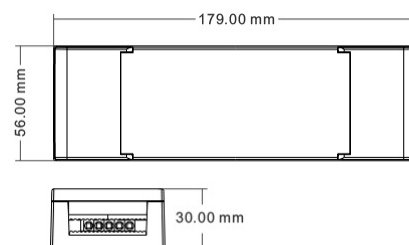

DIMMER / CONTROLADOR RGB+W+WW / CCT

IP20
 12-24 VDC
 PL
 5 CANAIS
 4A CANAL
 CE
 3 ANOS GARANTIA



REF. 2122246.4480

_Contém 4 modos de dispositivo diferentes DIM, CCT, RGBW e RGB + CCT num controlador e seleccionável pelo seletor;
 _Permite controlar ON / OFF, a intensidade da luz, a temperatura da cor e a cor RGB das luzes LED conectadas;
 _Pode emparelhar diretamente com um remoto compatível ZigBee via Touchlink;
 _É compatível com controlos remotos Zigbee universais.

_Contiene 4 modos de dispositivo diferentes DIM, CCT, RGBW y RGB + CCT en un controlador y seleccionable por selector;
 _Le permite controlar el encendido/apagado, la intensidad de la luz, la temperatura de color y el color RGB de las luces LED conectadas;
 _Puede emparejarse directamente con un control remoto compatible con ZigBee a través de Touchlink;
 _Compatible con controles remotos universales Zigbee.

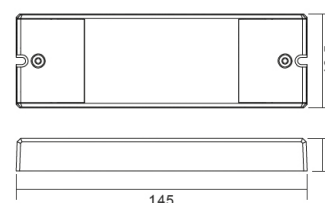

Modo	Tensão Tensión	Potência Potencia
DIM	12V	5x48W
DIM	24V	5x96W
CCT	24V	2x192W
RGB+W	24V	384W
RGB+W+WW	24V	480W

CONTROLADOR MINI DIMMER S/ NEUTRO

CONTROLADOR MINI REGULABLE SIN NEUTRO

IP20
 100 240 VAC
 PL
 200W
 PUSH
 CE



REF. 2133274.3400

_ Máx. carga: 400W incandescente, 200W LED a 230VAC
 _ Função Push DIM, funciona com interruptores existentes
 _ Compatível com gateways Zigbee 3.0 padrão universal

_ Carga máxima: 400W incandescente, 200W LED a 230VAC
 _ Función Push DIM, funciona con interruptores existentes
 _ Compatible con puertas de enlace Zigbee 3.0 estándar universal

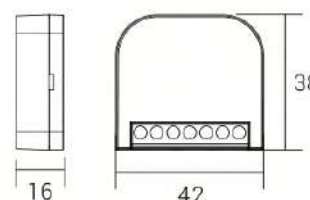

CONTROLADOR ZIGBEE

CONTROLADOR ZIGBEE

IP20
 230V
 200W
 PL
 1 CANAL
 1,5A CANAL
 CE



REF. 2122248.3200

_ Controlador ideal para todos os equipamentos de 240V com driver dimável;
 _ Dispositivo final ZigBee que suporta comissionamento Touchlink;
 _ Suporta rede zigbee de auto-formação sem coordenador e adiciona outros dispositivos à rede e outros produtos de gateway ZigBee universais;

_ Controlador ideal para todos los equipos de 240V con drivers regulables;
 _ Dispositivo final ZigBee compatible con la puesta en marcha de Touchlink;
 _ Admite la red zigbee de formación automática sin coordinador y agrega otros dispositivos a la red y con productos de gateway ZigBee universale;

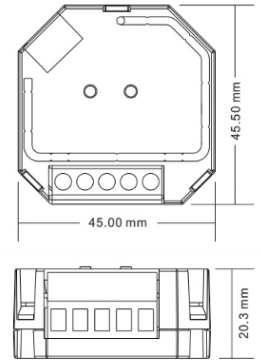

SUGESTÕES | SUGERENCIAS

Filtro de Proteção
 230Vac 480W Triac
 Filtro de Protección
 Ref. 2238280.3480

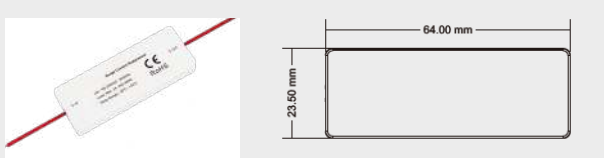

CONTROLADOR MINI ON/OFF S/ NEUTRO

CONTROLADOR MINI ON/OFF SIN NEUTRO

IP20
 100 240VAC
 16A
 CE



REF. 2133275.33000

_ Corrente Output: 16A - 240Vac / 10A - 30Vdc
 _ Potência Output: 3840W - 240Vac / 300W - 30Vdc

_ Corriente de Salida: 16A - 240Vac / 10A - 30Vdc
 _ Potencia de Salida: 3840W - 240Vac / 300W - 30Vdc

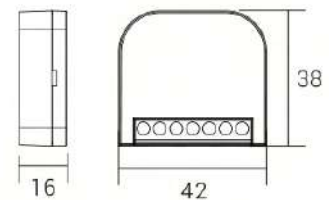

CONTROLADOR DE ESTORES

CONTROLADOR DE PERSIANAS

IP20
 100 240 VAC
 PL
 2 CANAIS
 2A CANAL
 CE



REF. 2122253.3430

_ Controlado por smart app ou diretamente pelo zigbee remote. Possibilidade de controle local com interruptores externos, mesmo que não seja adicionado a uma rede zigbee. Controle exato, suporta ON / OFF e controle de nível.

_ Controlado por aplicación inteligente o directamente por control remoto zigbee. Posibilidad de control local con interruptores externos, incluso si no se agrega a una red zigbee. Control exacto, soporte ON/OFF y control de nivel.

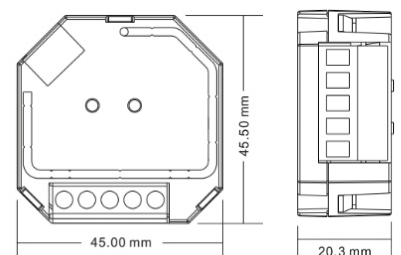

CONVERSOR ZIGBEE-DALI

CONVERTIDOR ZIGBEE-DALI

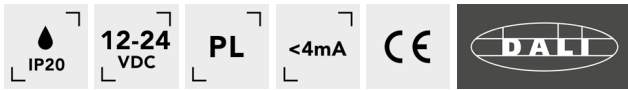

REF. 2222251.DA

_ Converte um sinal ZigBee-Dali para um endereço Dali;
 _ Conversor ideal para instalações em ZigBee e comandar equipamento com comandos Dali.

_ Convertir una señal ZigBee-Dali a una dirección Dali;
 _ Convertidor ideal para instalaciones ZigBee y equipos de control con mandos Dali.

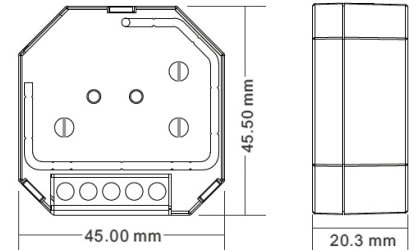

REF. 2222251.POWER

_ Converte um sinal ZigBee-PUSH para Dali ou 0/1-10V
 _ Capacidade Dali: 50mA
 _ Capacidade 0/1-10V: 20mA
 _ Capacidade de relé: 5A

_ Convierte una señal ZigBee-PUSH a Dali ou 0/1-10V
 _ Capacidad Dali: 50mA
 _ Capacidad 0/1-10V: 20mA
 _ Capacidad del relé: 5A

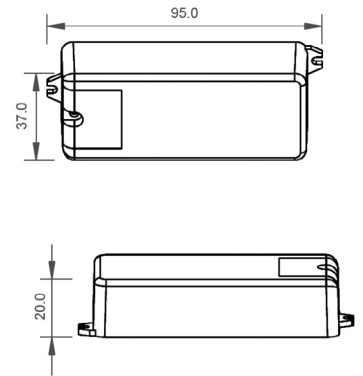

REF. 2122244.DA

_ Conversor Gama ECO com função 6 em 1: cor única, temperatura de cor, RGB, RGBW, RGB+CCT ou controlo de luz alternativa.

_ Convertidor ECO Gamma con función 6 en 1: monocolor, temperatura de color, RGB, RGBW, RGB+CCT o control de luz alternativo.

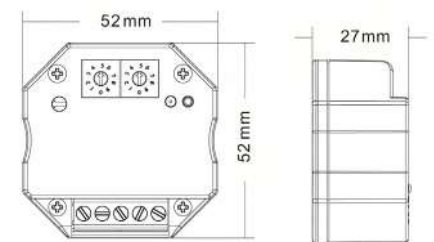

SENSOR DE PRESENÇA E CREPUSCULAR

SENSOR DE PRESENCIA Y CREPÚSCULO



REF. 2231265

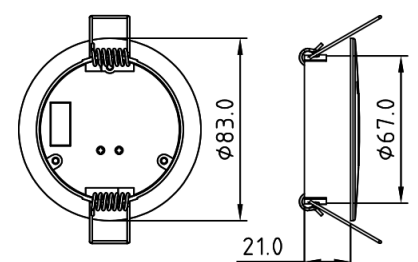

MÓDULO DE MEDIÇÃO DE CONSUMOS TRIFÁSICO

MÓDULO DE MEDIDA DE CONSUMO TRIFÁSICO



REF. 223168

100
240VAC

- _ Consumo: < 3W
- _ Amperímetros (RMS via CT para cada fase e Neutro): 0-120A
- _ Precisão dos amperímetros: < +5%
- _ Consumo: < 3W
- _ Amperímetros (RMS vía CT para cada fase y Neutro): 0-120A
- _ Precisión del amperímetro: < +5%

COMANDO TOUCH RGB+W+WW

MANDO TOUCH RGB+W+WW



REF. 2122246.RGB+W+WW

- _ Comando Zigbee 3 em 1 que permite controlar o escurecimento, o controlo de temperatura de cor e o controlo de cor RGB de dispositivos de iluminação Zigbee;
- _ Alcance de transmissão em espaço aberto: 30mt;
- _ Suporta máximo 30 dispositivos de iluminação;
- _ Tem 6 cenários predefinidos e permite salvar 5 cenários.
- _ Controlador Zigbee 3 en 1 que le permite controlar la atenuación, el control de temperatura de color y el control de color RGB de los dispositivos de iluminación Zigbee;
- _ Rango de transmisión en espacio abierto: 30mt;
- _ Admite un máximo de 30 dispositivos de iluminación;
- _ Tiene 6 escenarios preestablecidos y te permite guardar 5 escenarios.

COMANDO TOUCH PAREDE RGB+W

MANDO TOUCH PARED RGB+W



REF. 2122753.34CH

PL+VD

- _ Interface de vidro, sensível ao toque, cor RGB suave e controlo de intensidade de luz;
- _ Alcance de transmissão em espaço aberto: 30mt;
- _ Suporta máximo 30 dispositivos de iluminação;
- _ Frequência: 2,4GHz;
- _ Compatível com dispositivos de iluminação RGB ZigBee universais.
- _ Interfaz de vidrio sensible al tacto, color suave RGB y control de intensidad de luz;
- _ Rango de transmisión en espacio abierto: 30mt.
- _ Admite un máximo de 30 dispositivos de iluminación;
- _ Frecuencia: 2,4 GHz;
- _ Compatible con dispositivos de iluminación ZigBee RGB universales.

COMANDO CONTROLO COR SIMPLES

MANDO CONTROLO COLOR SIMPLE



REF. 2122218.DIM4

PL

- _ Comando Zigbee 4 canais;
- _ Alcance de transmissão em espaço aberto: 30mt;
- _ Suporta máximo 30 dispositivos de iluminação;
- _ Compatível com dispositivos Zigbee de cor única universal;
- _ Frequência 2,4GHz.
- _ Envío Zigbee 4 canales;
- _ Rango de transmisión en espacio abierto: 30mt;
- _ Admite un máximo de 30 dispositivos de iluminación;
- _ Compatible con dispositivos Zigbee universales de un solo color;
- _ Frecuencia de 2,4 GHz.

COMANDOS MANDOS



REF. 212218.ROT Comando Control DIM Rotativo 4 cenários
Mando de Control DIM Rotativo 4 escenarios

- _ Altere o brilho da cor através da rotação do comando
- _ Instalação sobre mesa ou afixação na parede.
- _ Combinação de cinco botões físicos e um botão rotativo
- _ Cambie el brillo del color mediante la rotación del comando
- _ Instalación sobre mesa o montaje en pared.
- _ Combinación de cinco botones físicos y un mando giratorio

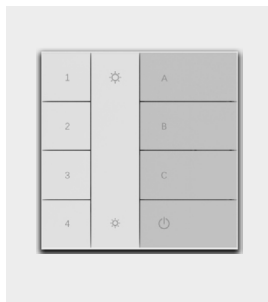

REF. 2222266.DIM4

**Comando 4 canais Control
Cor Simples de Parede**
Mando de pared de control
de color simple de 4 canales



REF. 2222252.4CH

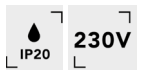

Módulo de 4 Entradas
Módulo de 4 entradas

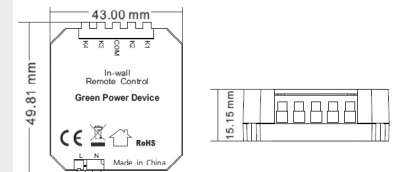

CONTROLADOR ZIGBEE RF/PUS+DALI CONTROLADOR ZIGBEE RF/PUS + DALI



REF. 2137244.115

**Controlador DALI com
entrada ZigBee e RF e saída
de sinal DALI**
Controlador DALI con
entrada ZigBee y RF y salida
de señal DALI

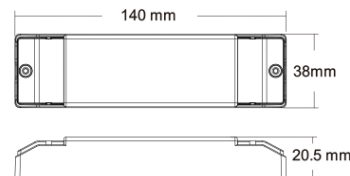

MÓDULO 4 ENTRADAS S/ FIOS MÓDULO 4 ENTRADAS SIN FIOS

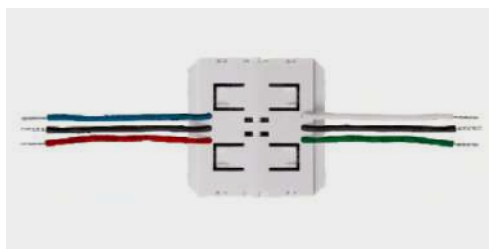

REF. 2222267.4CH

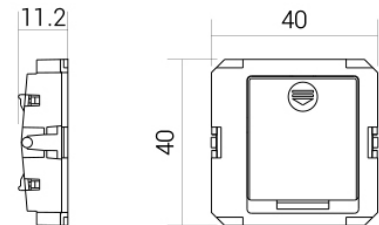

- _ Este transmissor envia sinais de rádio sem fio que são usados para controlar remotamente o sistema Zigbee compatível.
- _ O switch pode ser configurado através do Zigbee App depois de adicionado ao hub Zigbee. Este interruptor possui quatro botões para acionar diferentes ações de dispositivos ou zonas
- _ A ação de cada botão pode ser configurada através do Zigbee App.
- _ Este transmissor envía señales de radio inalámbricas que se utilizan para controlar de forma remota el sistema Zigbee compatible.
- _ El conmutador se puede configurar a través de la aplicación Zigbee después de agregarlo al concentrador Zigbee. Este interruptor tiene cuatro botones para activar diferentes acciones de dispositivo o zona.
- _ La acción de cada botón se puede configurar a través de la App Zigbee.

FONTE CVZ IP20
FUENTE CVZ



Modelo	Ref.	Input	Tensão Tensión	Potência Potencia
	2022521.275	220-240Vac	24V	75W
CVZ	2022521.2100	220-240Vac	24V	100W
	2022521.2150	220-240Vac	24V	150W

75W / 100W

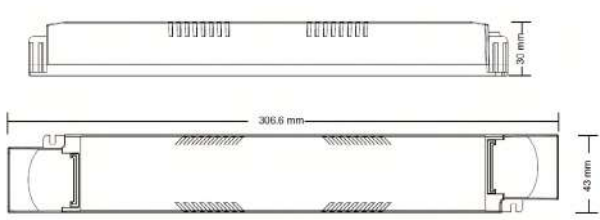

150W

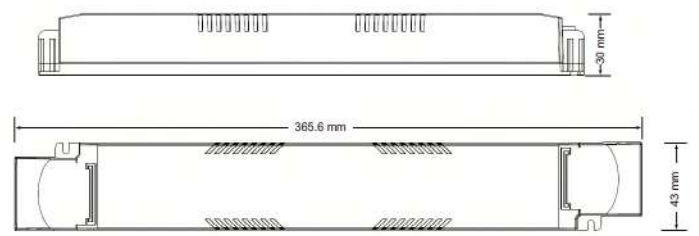

DRIVER CC DIMÁVEL NFC IP20
DRIVER CC REGULABLE NFC

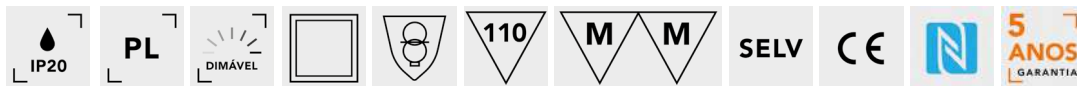

Ref.	Tensão Tensión	Corrente Corriente	Potência Potencia
2023901.8139	3-42V	100-500mA	10W
2023901.9114	6-54V	350-1050mA	36W

10W

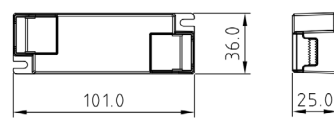

36W

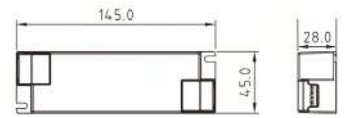

DRIVER CC LINEAR DIMÁVEL NFC IP20
DRIVER CC LINEAL REGULABLE NFC



Ref.	Tensão Tensión	Corrente Corriente	Potência Potencia
2024901.8352	50-220V	80-400mA	40W



- matter
- +
- zigbee 3.0
- +
- Apple Home

CONTROLADOR DIM / CCT / RGBW / RGB+CCT

- IP20
- PL
- 12-24 VDC
- 5 CANAIS
- 4A CANAL
- 5x96W
- CE

REF. 2124234.44480

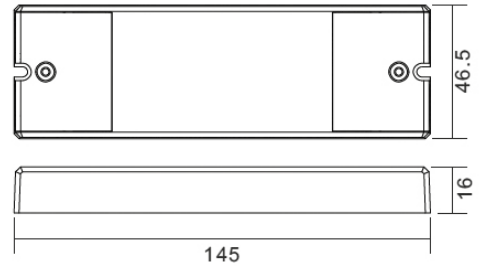

CONTROLADOR DIM S/ NEUTRO

- IP20
- PL
- 100 240VAC
- 200W
- PUSH
- CE

REF. 2131234.3400

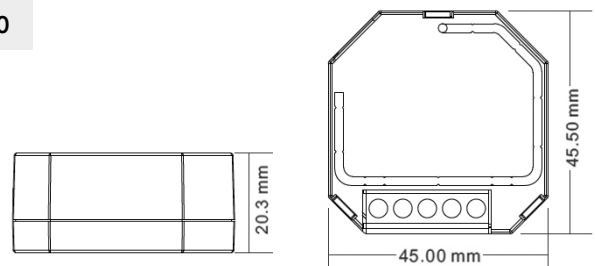

CONTROLO DMX

Smart Home

CONTROADOR DE RGB DMX512

CONTROLADOR DE RGB DMX512



REF. 215422.4960

Controlador RGB+W+WW DMXPRO
Controlador RGB+W+WW DMXPRO

_Entradas: 2 x RJ45 / 2 x XLR; possui ecrã digital para programação e saída PWM de alta resolução 8-16bit.

_Entradas: 2 x RJ45 / 2 x XLR; tiene pantalla digital para programación y salida PWM de 8-16 bits de alta resolución.

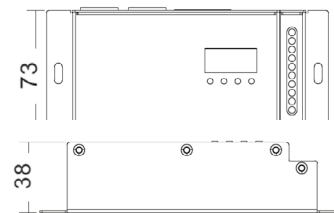

214722.440CH

Comando RGB+W
Control DMXPRO,
1 zona

Mando RGB+W
Control DMXPRO,
1 zona



2119749.RGB+W+WW

Comando RGB+W+WW
Control DMXPRO,
4 zonas

Mando RGB+W+WW
Control DMXPRO,
4 zonas

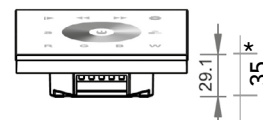
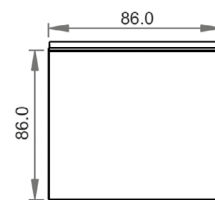

_Sensível ao toque, interface de vidro (branco e preto); modo de funções de salvar cor.

_Interfaz de vidrio sensible al tacto (blanco y negro); modo de funciones de ahorro de color.

388 M O T A K O

CONTROLADOR DIMMER DMX512 + TRIAC

CONTROLADOR REGULABLE DMX512 + TRIAC



REF. 2125248.3576

- _Dimmer de controlo de fase direta (TRIAC) e dimmer de controlo de fase reversa disponíveis;
- _Excelente compatibilidade com uma grande variedade de controlos DMX512;
- Função inovadora de configuração de brilho mínimo.
- _Control de fase directa regulable (TRIAC) y control de fase inversa regulable disponibles;
- _Excelente compatibilidad con una amplia variedad de controles DMX512;
- Innovadora función de ajuste de brillo mínimo.

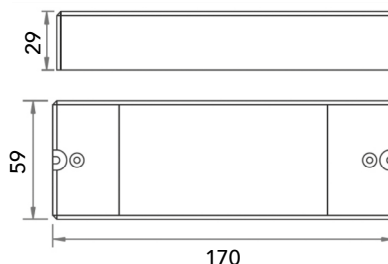

CONTROLADOR RGB DMX - TRIAC

CONTROLADOR REGULABLE DMX512 + TRIAC



REF. 214222.31000

- _Com funções Master / Decoder comutáveis
- _Display digital de endereço resistente a altas temperaturas
- _Con funciones Master / Decoder conmutables
- _Pantalla de dirección digital resistente a altas temperaturas

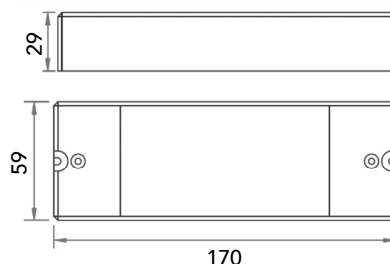



O KNX é o único padrão de controlo residencial e predial a executar esquemas de certificação global. A ideia por trás do KNX é tão simples quanto engenhosa.

O KNX combina todas as funções principais de um edifício, como iluminação, aquecimento, ventilação, segurança, gestão de energia e entre outros, num único sistema inteligente.

Neste sistema, todos os dispositivos comunicam através de um único cabo instalado junto das linhas de energia normais, significando que todas as funções elétricas são conectadas umas às outras através do sistema de barramento.

Isto ajuda a reduzir os custos operacionais, resultando numa considerável economia de energia, além de economizar tempo de instalação e aumentar a flexibilidade.

KNX es el único estándar de control de viviendas y edificios que ejecuta esquemas de certificación global. La idea detrás de KNX es tan simple como ingeniosa.

KNX combina todas las funciones principales de un edificio, como iluminación, calefacción, ventilación, seguridad, gestión de energía y más, en un único sistema inteligente.

En este sistema, todos los dispositivos se comunican a través de un solo cable instalado a lo largo de las líneas eléctricas normales, lo que significa que todas las funciones eléctricas están conectadas entre sí a través del sistema de bus.

Esto ayuda a reducir los costes operativos, lo que se traduce en un ahorro energético considerable, además de ahorrar tiempo de instalación y aumentar la flexibilidad. Una vez que se completa el ensamblaje, debe reconfirmar la EMC del sistema.

CONTROLOADORES KNX

CONTROLOADORES KNX



REF. 219225.5480

Controlador RGB+W KNX

Controlador RGB+W com entrada KNX, este é um controlador programável para KNX que permite controlo em PWM para RGB+W.

Ideal para aplicações em instalações com sistemas de gestão integrado onde o protocolo é KNX.

Controlador RGB+W con entrada KNX, este es un controlador programable para KNX que permite el control PWM para RGB+W.

Ideal para aplicaciones en instalaciones con sistemas de gestión integrados donde el protocolo es KNX.

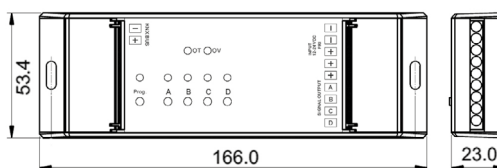

REF. 201481.919

Fonte de Alimentação BUS KNX para Calha Din

Fuente de Alimentación BUS KNX para Calha Din

Para instalações de maior dimensão, também disponível em 128mA BUS POWER SUPPLY (KNX-40E-1280).

Para instalaciones más grandes, también disponible en 128mA BUS POWER SUPPLY (KNX-40E-1280).

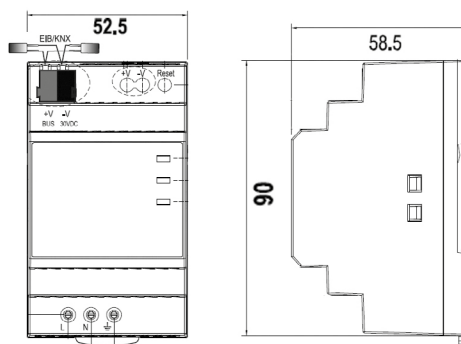







AMPLIFICADORES

Amplificadores

AMPLIFICADORES / REPETIDORES DE POTÊNCIA
AMPLIFICADORES / REPETIDORES DE POTENCIA



IP20	230V	PL
1 CANAL	2,5A CANAL	250W A 600W
CE	LED 300W	

REF. 216248.3600
Amplificador Dimmer TRIAC 230V

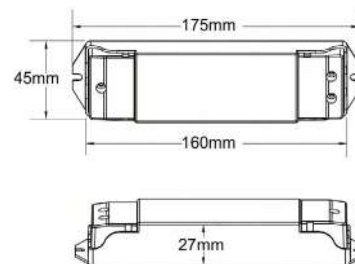

IP20	12-24 VDC	PL
1 CANAL	15A CANAL	CE

REF. 216218.4360
Amplificador Dimmer

12V DC	180W	24V DC	360W
--------	------	--------	------

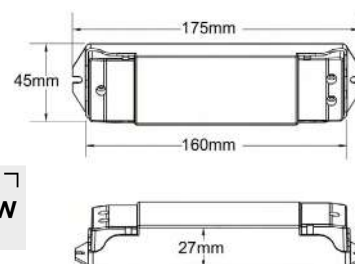

5-24V DC	10A CANAL	3 CANAIS
+60° -20°	CE	

REF. 214417.1720
Amplificador RGB

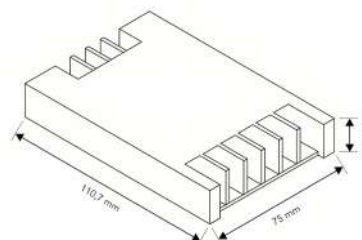

12-36 VDC	PL	4 CANAIS
5A CANAL	CE	

REF. 216217.4480
Amplificador RGB+W

12V DC	4x60W	24V DC	4x120W
--------	-------	--------	--------



12-24 VDC	AL PRETO	5 CANAIS
5A CANAL	CE	

REF. 216433.4560
Amplificador RGB+W+WW

12V DC	5x60W	24V DC	5x120W
--------	-------	--------	--------

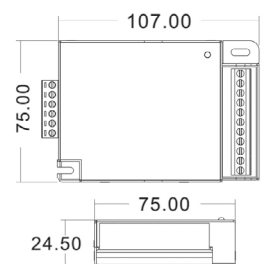



PERFIS ARQUITETURAIS

Perfiles Arquitectónicos

INDÍCE DE IMAGEM

ÍNDICE DE IMÁGENES

SANCAS LUZ INDIRECTA MOLDURAS DE LUZ INDIRECTA

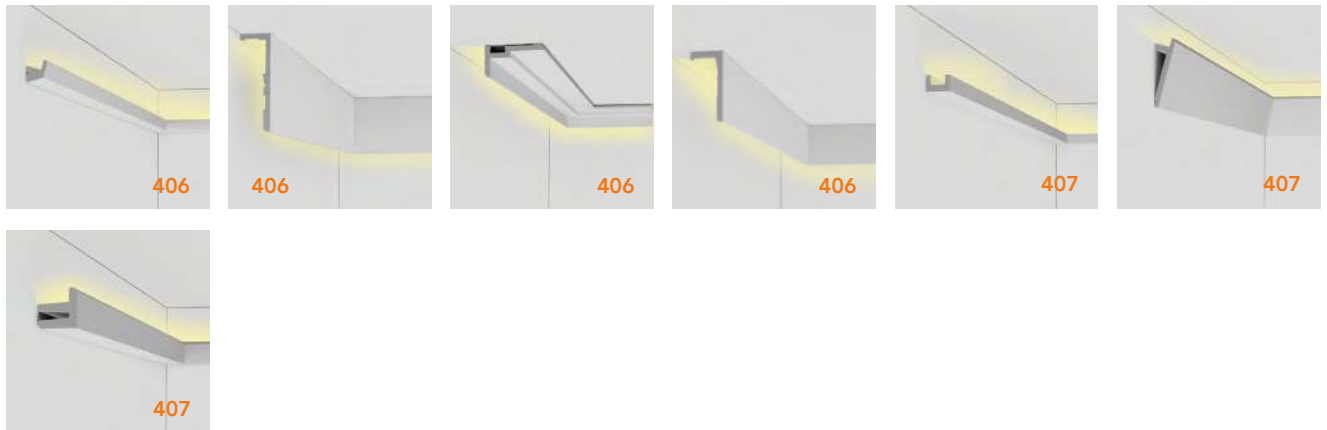

SALIENTES

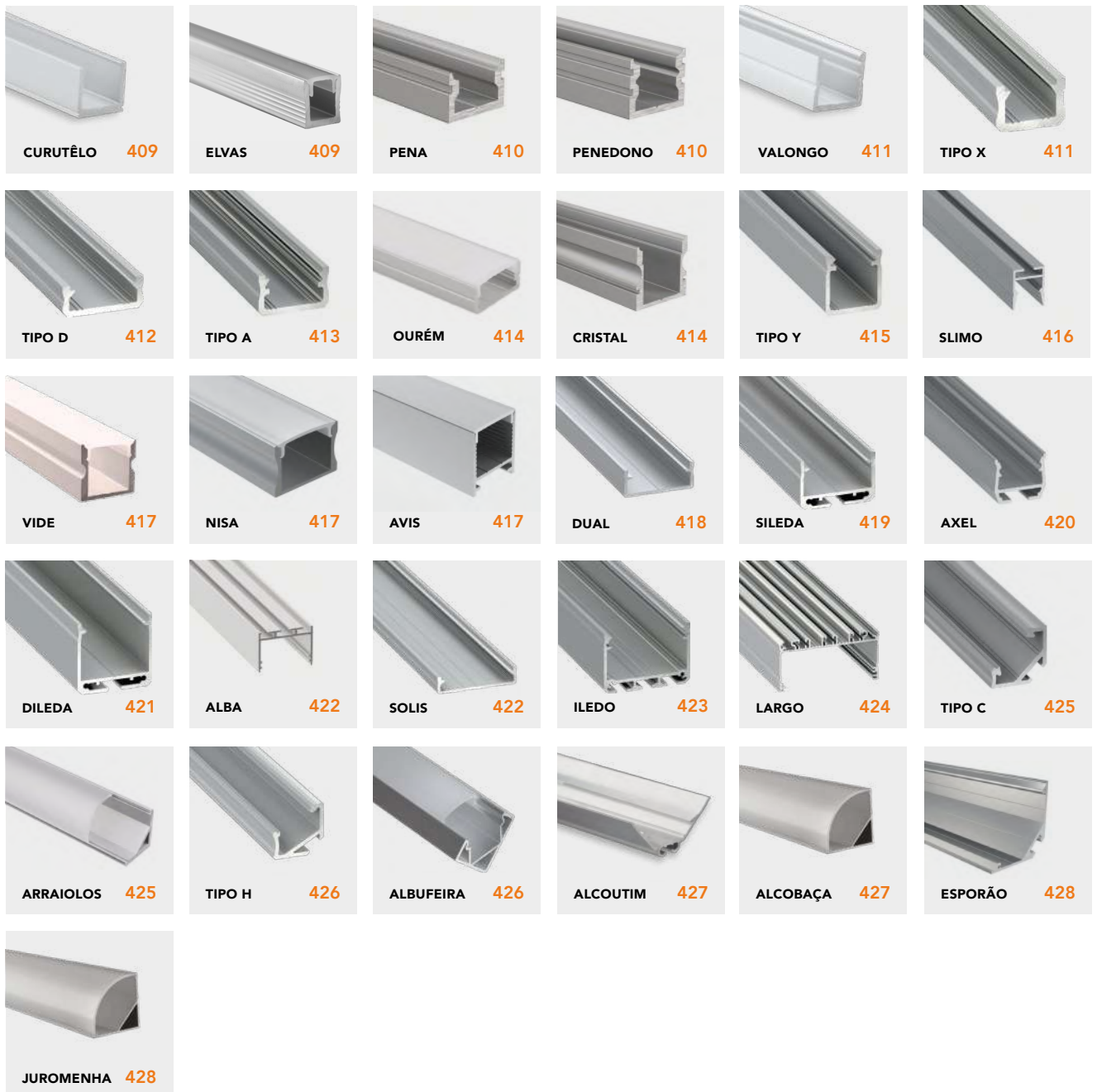

ÍNDICE DE IMAGEM

ÍNDICE DE IMÁGENES

ENCASTRE EMPOTRAR



ENCASTRE CERÂMICA EMPORTAR CERAMICA



BARRAMENTO BARRAMIENTO (1/2)



ÍNDICE DE IMAGEM

ÍNDICE DE IMÁGENES

BARRAMENTO BARRAMIENTO (2/2)



MONTALEGRE 459



ZATI 460

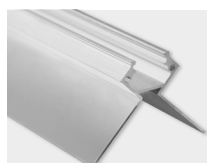

LAMEGO 461

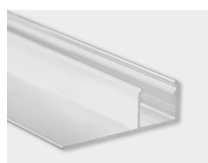

PALMELA 461



BRUNO 462



FALCO 463



TOMAR 464

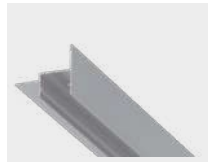

MOTTA 464



PLATO 465

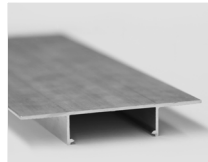

SAFARUJO 466

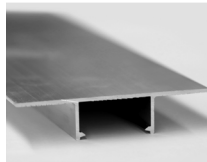

MOGOS 466



SUBLI 468



SORGA 469



MÉRTOLA 470

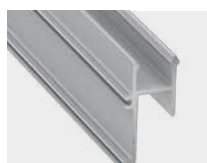

APA 12 471



IPA 12 471



BORBA 472

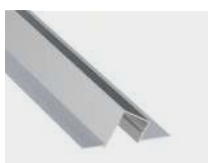

DUO 472



VEDA 473



TOPE 473

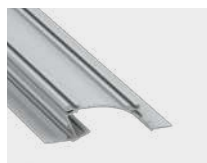

PERO 473

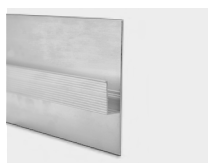

MONSANTO 474

SUSPENSÃO SUSPENSIÓN

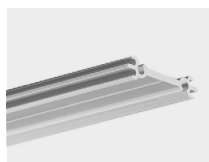

JAZ DUO 477



DULIO 478



FIXO 479

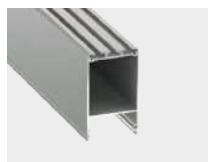

CLARO 480



FOLDO 481

PAVIMENTO PISO



TERRA 484



RUNO 484

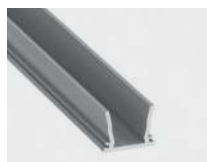

STRADA 485



MOUROS 486



MONSERRATE 486



SÃO JORGE 486

INDÍCE DE IMAGEM

ÍNDICE DE IMÁGENES

DEGRAUS ESCALONES



APLICAÇÃO ESPECIAL APLICACIÓN ESPECIAL



RODAPÉ RODAPIÉ



DIFUSORES

CONHECE OS NOSSOS DIFUSORES EM ROLO?

¿CONOCES NUESTROS DIFUSORES DE ROLLO?

Use o difusor de rolo com 10, 20, 30 e 50 metros para trabalhos com comprimentos de perfil superiores a 3 metros, evitando os cortes de difusor e obtendo uma linha contínua e sem interrupções.

Utilice el difusor enrollable de 10, 20, 30 y 50 metros para trabajos con longitudes de perfil superiores a 3 metros, evitando el difusor cortes y obteniendo una línea continua e ininterrumpida.



	Semi Opalino Semi Opal	Opalino Opal
10m	DF1SOE.10 DF3SOE.10	DF1OE.10 DF3OE.10
20m	DF1SOE.20 DF3SOE.20	DF1OE.20 DF3OE.20
30m	DF1SOE.30 DF3SOE.30	DF1OE.30 DF3OE.30
40m	DF1SOE.40 DF3SOE.40	DF1OE.40 DF3OE.40
50m	DF1SOE.50 DF3SOE.50	DF1OE.50 DF3OE.50

Transparente
(Transparent)

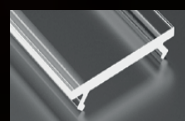

94% a 95%*
-20°C/+70°C

Prismático
(Prismatic
transparent)

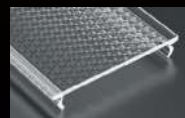

87%*
-50°C/+100°C

Fosco / Mate
(Milky Frosted)



74% a 83%*
-20°C/+70°C

Semi-Opalino
Semi-Opal
(Frozen)

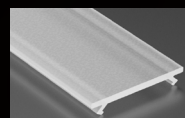

73% a 79%*
-20°C/+70°C

Opalino / Opal
(Milky)



39% a 44%*
-20°C/+70°C

Preto / Negro
(Black)

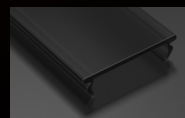

25%*
-20°C/+70°C

* Varia consoante a linha de difusores. / Varía según la línea de difusores.

CONHECE O NOSSO DIFUSOR DE LAMELAS?

¿CONOCES NUESTRO DIFUSOR LAMELAS?

Este difusor defende-nos do encadeamento, por barrar a direção da luz. Torna-se ideal para ambientes de trabalho.

Este difusor nos protege del deslumbramiento bloqueando la dirección de la luz. Se vuelve ideal para ambientes de trabajo.

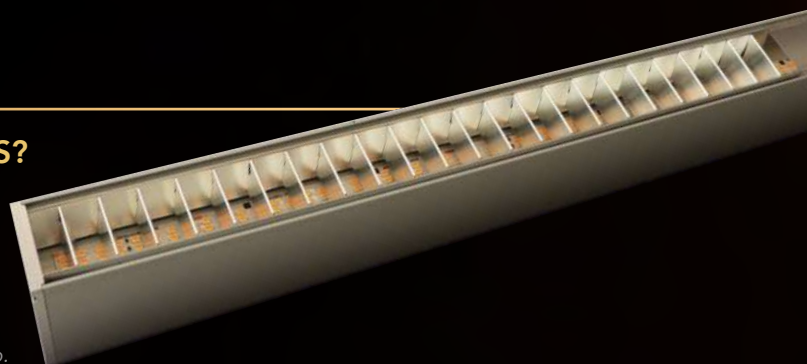

ESCOLHA A COR DO SEU PERFIL

ELIGE EL COLOR DE TU PERFIL

Para além de uma vasta gama de acabamento de perfis à sua disposição, agora já pode personalizar a cor do perfil à sua escolha.

Dê-nos o RAL da cor que pretende e apresentamos-lhe um perfil personalizado com uma cor única, à medida da solução que necessita.*

Además de una amplia gama de acabados de perfil a tu disposición, ahora puedes personalizar el color del perfil de tu elección.

Danos el color RAL que deseas y te presentaremos un perfil personalizado con un color único, a la medida de la solución que necesitas.*

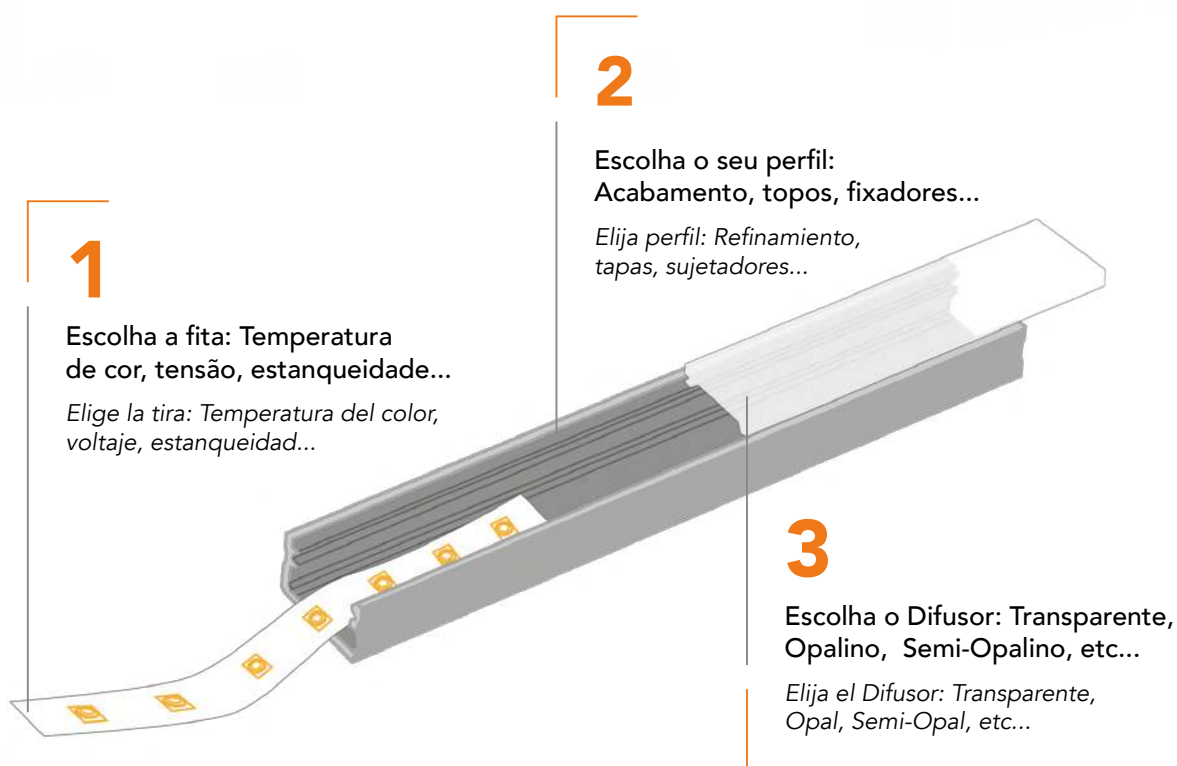

IMAGINE E IDEALIZE, NÓS PRODUZIMOS!
IMAGINA E IDEALIZA, NOSOTROS PRODUCIMOS!

* Cores produzidas apenas por encomenda. Encomenda mínima de 50m por modelo. Prazo de entrega sob consulta. Colores producidos solo por pedido. Pedido mínimo de 50m por modelo. Plazo de entrega bajo petición.

ORAC

Explore a gama de sancas ORAC, elementos pensados para realçar os espaços interiores com elegância e personalidade. Perfeitas para transformar as junções entre paredes e tetos, as sancas conferem um acabamento requintado, quer pretenda um estilo clássico ou um toque moderno. Quando aliadas à iluminação led, as sancas ganham uma nova dimensão, criando efeitos de luz indireta que acrescentam profundidade, conforto visual e um aspeto verdadeiramente incrível aos ambientes.

Explore la gama de molduras ORAC, elementos diseñados para realzar los espacios interiores con elegancia y personalidad. Perfectas para transformar las uniones entre paredes y techos, las molduras aportan un acabado refinado, tanto si busca un estilo clásico como un toque moderno. Cuando se combinan con la iluminación LED, las molduras adquieren una nueva dimensión, creando efectos de luz indirecta que añaden profundidad, comodidad visual y un aspecto realmente increíble a los ambientes.



SANCAS LUZ INDIRECTA

Sancas Luz indirecta

VARA
2m

NOVO
NUEVO

SANCA LUZ INDIRECTA

REF. ORACCX189

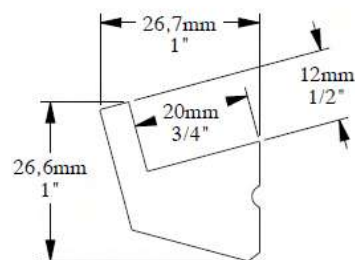

SANCA LEDGE

REF. ORACCX217-2600

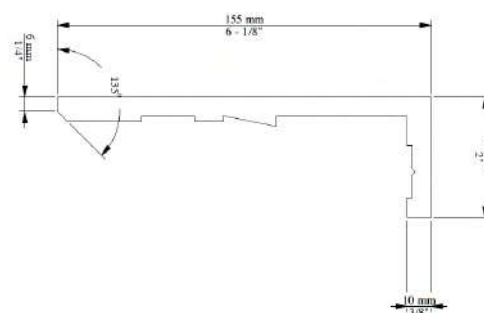
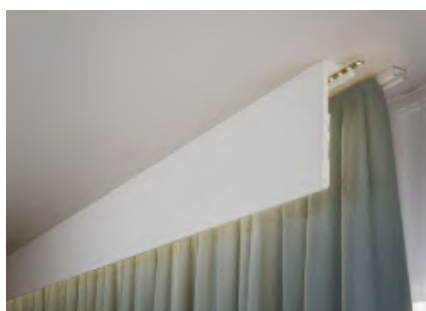

SANCA 'U-STEPS'

REF. ORACCX197

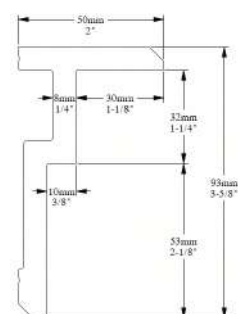
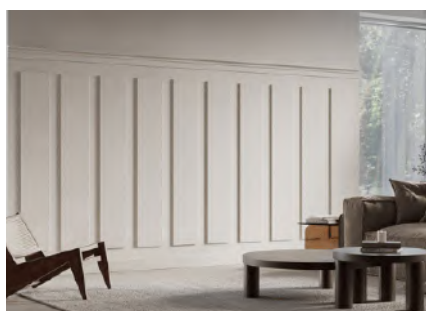

SANCA LUZ INDIRECTA

REF. ORACCX215-2600

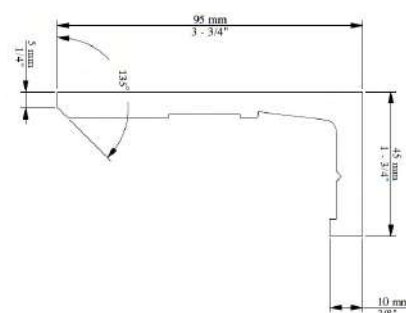
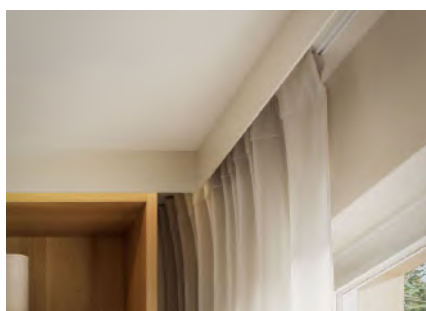

VARA
2m

NOVO
NUEVO

SANCA 'U-PROFILE'

REF. ORACC190

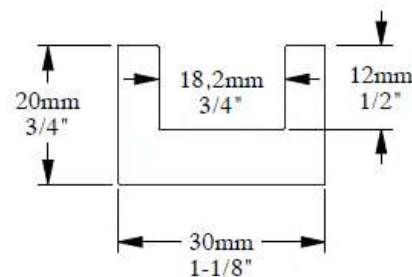

SANCA DIAGONAL

REF. ORACSX179

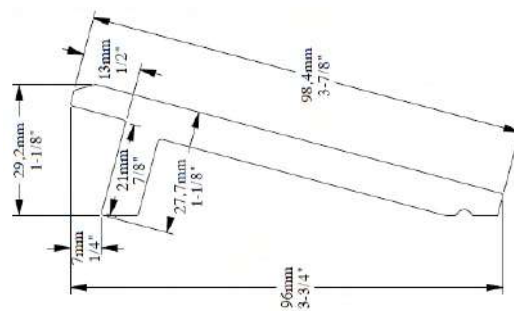

SANCA L3

REF. ORACC380

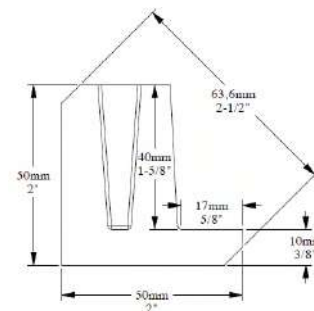
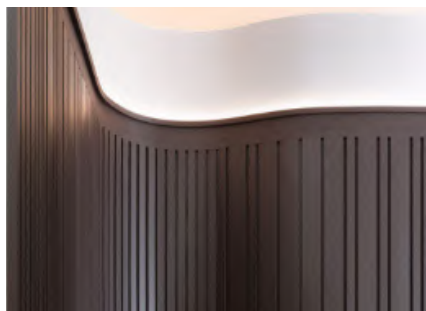

Perfil de alumínio de aplicação saliente tem a função de assegurar a dissipação da fita LED. Os perfis salientes são frequentemente utilizados em rasgos para resultados de aplicações sem aba visível. A grande versatilidade é a possibilidade de realizar luminárias salientes com dimensões à medida pretendida para os locais desejados.

El perfil de aluminio de aplicación superficial tiene la función de asegurar la disipación de la tira LED. Los perfiles elevados se utilizan a menudo en ranuras para resultados de aplicación sin solapa visible. La gran versatilidad es la posibilidad de realizar luminarias de superficie con las dimensiones deseadas para los lugares deseados.

PERFIS SALIENTES

Perfiles Salientes

PERFIS SALIENTES

PERFIL CURUTÊLO



Aplicação | Aplicación:
Saliente

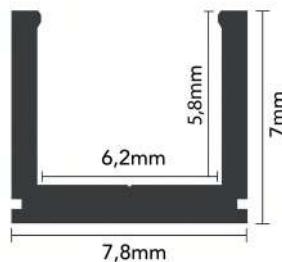

Ref.	Cor Color
PFG01060	Anodizado Anodizado
PFG01062	Anodizado Preto Anodizado Negro

	TPG01065	Topo Silicone Cinza Tapa Silicona Gris
--	----------	---

	DFG00106	Difusor Semi-Opalino Difusor Semi-Opal
	DFG00106.6	Difusor Semi-Opalino 6mt Difusor Semi-Opal 6mt



PERFIL ELVAS

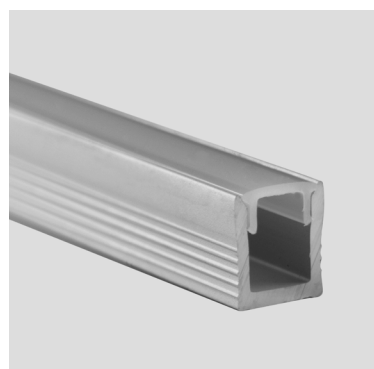

Aplicação | Aplicación: Saliente

Perfil usado principalmente para iluminar armários, escadas, vitrines ou como luz decorativa para nichos em tetos de gesso cartonado.

Perfil utilizado principalmente para iluminar armarios, escaleras, vitrinas o como luz decorativa para nichos en techos de cartón yeso.

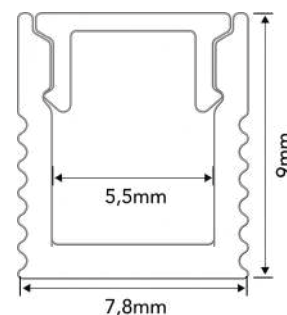

Ref.	Cor Color
ELVAS PFA1871	Anodizado c/ Difusor Semi-Opalino Anodizado c/ Difusor Semi-Opalino

Ref.	Cor Color
TP1871	Topo PL Tapa PL
TPF1871	Topo c/ furo PL Topo c/ Orificio
FX1871	Fixador de Metal Fijador de Metal

PERFIS SALIENTES

PERFIL PENA



Aplicação | Aplicación:
Saliente

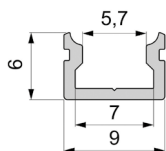

Ref.	Cor Color
PFD0081	Anodizado Anodizado
PFD0083	Preto Mate Negro Mate
PFD0085	Branco Mate Blanco Mate

	TPD8661	
	TPD8662	
	TPD8660	
	TPD9161	
	TPD9162	
	TPD9160	
	TPD9661	
	TPD9662	
	TPD9660	

DIFUSORES
Difusor Opalino
Difusor Opal



DFD3555



DFD4055



DFD4555

PERFIL PENEDONO



Aplicação | Aplicación:
Saliente

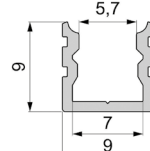

Ref.	Cor Color
PFD0181	Anodizado Anodizado
PFD0183	Preto Mate Negro Mate
PFD0185	Branco Mate Blanco Mate

	TPD8671	
	TPD8672	
	TPD8670	
	TPD9171	
	TPD9172	
	TPD9170	
	TPD9671	
	TPD9672	
	TPD9670	

DIFUSORES
Difusor Opalino
Difusor Opal



DFD3555



DFD4055



DFD4555



PERFIS SALIENTES

PERFIL VALONGO



Aplicação | Aplicación:
Saliente

Ref. Cor | Color

PFG01050 Anodizado
 Anodizado

PFG01051 Anodizado Preto
 Anodizado Negro

PFG01052 Lacado Branco
 Laca Blanco

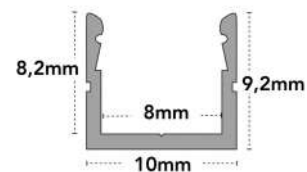

	TPG01055 <input checked="" type="checkbox"/> Topo Silicone Cinza Tapa Silicona Gris
	FXG01057 Fixador Fijador

	DFG00046 Difusor Semi-Opalino Difusor Semi-Opal
	DFG00074 Difusor Preto Difusor Negro



PERFIL TIPO X



MOTAKO: Perfil XANGAI

Potência máxima | Potencia máxima: 18W/mt

Aplicação | Aplicación: Saliente



Ref. Cor | Color

PFA1111 Anodizado

PFA1112 Lacado Branco
 Laca Blanco

PFA1118 Anodizado Preto
 Anodizado Negro

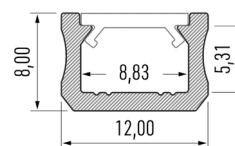

TP1111 Topo PL Cinza
Tapa PL Gris

TP1112 Topo PL Branco
Tapa PL Blanco

TP1118 Topo PL Preto
Tapa PL Negro



FX111 Fixador Transparente
Fijador Transparente

Perfil saliente, ideal para uma iluminação discreta e decorativa, para cozinhas, móveis e acabamentos interiores. Tem design minimalista que permite a instalação em locais com espaço reduzido. A baixa altura do perfil e a tampa plana tornam-no num acessório muito discreto para fitas de LED. A utilização deste perfil garante uma linha de luz fina e agradável.

Perfil saliente, ideal para una iluminación discreta y decorativa, para cocinas, muebles y acabados de interior. Tiene un diseño minimalista que permite su instalación en lugares con espacio reducido. La altura del perfil bajo y la cubierta plana lo convierten en un accesorio muy discreto para tiras de LED. El uso de este perfil garantiza una línea de luz fina y agradable.

DIFUSORES



DF6SO

Difusor Semi-Opalino
Difusor Semi-opal

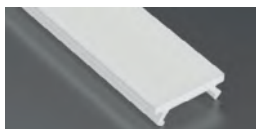

DF6O

Difusor Opalino
Difusor Opal

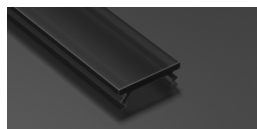

DF6PT

Difusor Preto
Difusor Negro



PERFIS SALIENTES

PERFIL TIPO D



Potência máxima | Potencia máxima: 16W/mt
 Aplicação | Aplicación: Saliente

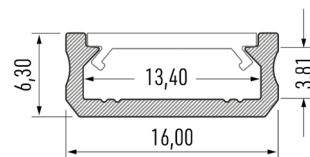

Ref.	Cor Color
PFA1191	Anodizado Anodizado
PFA1192	Lacado Branco Laca Blanco
PFA1197	Não Anodizado No Anodizado
PFA1198	Anodizado Preto Anodizado Negro
PFA1191.3	Anodizado 3mt Anodizado 3mt
PFA1192.3	Lacado Branco 3mt Laca Blanco 3mt
PFA1197.3	Não Anodizado 3mt No Anodizado 3mt
PFA1198.3	Anodizado Preto 3mt Anodizado Negro 3mt

Ref.	Cor Color
TP1191	Topo PL Cinza Tapa PL Gris
TP1192	Topo PL Branco Tapa PL Blanco
TP1198	Topo PL Preto Tapa PL Negro
FX119	Fixador Transparente Fijador Transparente
228421	Fixador Orientável Fijador Orientable

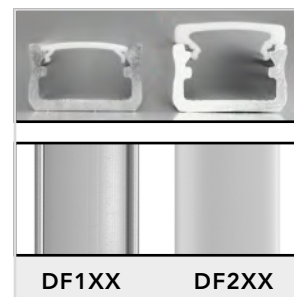

DIFUSORES

DF1LT DF1LT30 Difusor Lente 15° Difusor Lente 30°	DF1T Difusor Transparente	DF1SOE* Difusor Semi-Opalino Difusor Semi-Opal	DF1F Difusor Fosco Difusor Mate	DF1OE* Difusor Opalino Difusor Opal	DF1PT DF1PT.3 Difusor Preto Difusor Negro
DF2ST Difusor Alto Semi-Transparente	DF2SO Difusor Alto Semi-Opalino Difusor Alto Semi-Opal	DF2O Difusor Alto Opal Difusor Alto Opal	DF2PT Difusor Alto Preto Difusor Alto Negro		

*Disponível em:
 *Disponible en:

VARA 3m	10m	20m	30m	40m	50m
DF1SOE.3	DF1SOE.10	DF1SOE.20	DF1SOE.30	DF1SOE.40	DF1SOE.50
DF1OE.3	DF1OE.10	DF1OE.20	DF1OE.30	DF1OE.40	DF1OE.50

PERFIS SALIENTES

PERFIL TIPO A



Perfil Andorra



Potência máxima | Potencia máxima: 22,2W/mt
 Aplicação | Aplicación: Saliente

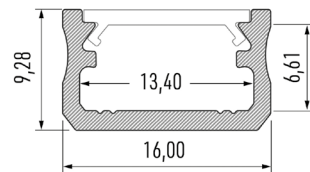

Ref.	Cor Color
PFA111	Anodizado Anodizado
PFA112	Lacado Branco Laca Blanco
PFA117	Não Anodizado No Anodizado
PFA118	Anodizado Preto Anodizado Negro
PFA1110	Champanhe Champán
PFA111.3	Anodizado 3mt Anodizado 3mt
PFA112.3	Lacado Branco 3mt Laca Blanco 3mt
PFA117.3	Não Anodizado 3mt No Anodizado 3mt
PFA118.3	Anodizado Preto 3mt Anodizado Negro 3mt
TPH111	Topo Alto PL Cinza Tapa Alto PL Gris
TPH112	Topo Alto PL Branco Tapa Alto PL Blanco
TPH118	Topo Alto PL Preto Tapa Alto PL Negro
228421	Fixador Orientável Fijador Orientable

Ref.	Cor Color
TP111	Topo PL Cinza Tapa PL Gris
TP112	Topo PL Branco Tapa PL Blanco
TP118	Topo PL Preto Tapa PL Negro
TP1110	Topo PL Champanhe Tapa PL Champán
TPA111	Topo Alumínio Tapa Aluminio
TPF111	Topo PL c/ furo Cinza Tapa PL c/ agujero Gris
TPF112	Topo PL c/ furo Branco Tapa PL c/ agujero Blanco
FX11	Fixador Transparente Fijador Transparente
FXL11	Fixador Alto Transparente Fijador Alto Transparente
FXM11	Fixador de Metal Fijador de Metal
FX118	Fixador Preto Fijador Negro

DIFUSORES

DF1LT DF1LT30 Difusor Lente 15° Difusor Lente 30°	DF1T Difusor Transparente	DF1SOE* Difusor Semi-Opalino Difusor Semi-Opal	DF1F Difusor Fosco Difusor Mate	DF1OE* Difusor Opalino Difusor Opal	DF1PT DF1PT.3 Difusor Preto Difusor Negro
				*Disponível em: / Disponible en: DF1SOE.3 DF1SOE.10 DF1SOE.20 DF1OE.3 DF1OE.10 DF1OE.20 DF1SOE.30 DF1SOE.40 DF1SOE.50 DF1OE.30 DF1OE.40 DF1OE.50	
DF2ST Difusor Alto Semi-Transparente	DF2SO Difusor Alto Semi-Opalino Difusor Alto Semi-Opal	DF2O Difusor Alto Opalino Difusor Alto Opal	DF2PT Difusor Alto Preto Difusor Alto Negro		

PERFIS SALIENTES

PERFIL OURÉM

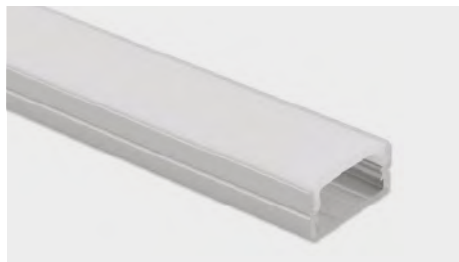

Aplicação | Aplicación: Saliente

Perfil Saliente baixo s/ abas

Perfil Saliente bajo s/ solapas

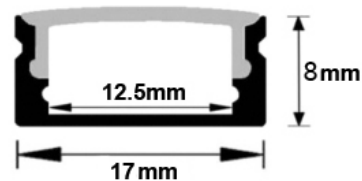

Modelo	Ref.	Cor Color
OURÉM	PF101	Anodizado c/ Difusor Semi-Opalino Anodizado c/ Difusor Semi-Opalino
	PFT101	Anodizado c/ Difusor Transparente Anodizado c/ Difusor Transparente

Modelo	Ref.	Cor Color
TORRE DE OURÉM	PF11011	Perfil Anodizado sem Difusor Perfil Anodizado sin Difusor
	DF15SO*	Difusor Semi-Opalino Difusor Semi-Opalino

Ref.	Acessórios
TP101	Topo final Tapa final
TPF101	Topo c/ passagem de fio Tapa c/ pasacable
FX101	Fixador Metal Fijador Metal

*Disponível em | Disponible en:



DF15SO DF15SO.10 DF15SO.20 DF15SO.50

PERFIL CRISTAL

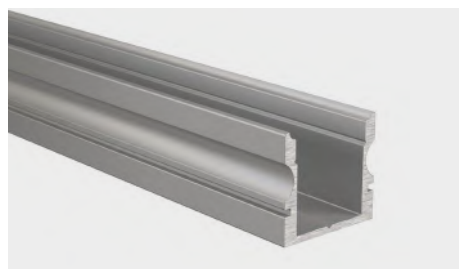

Aplicação | Aplicación: Saliente

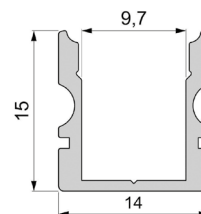

Ref.	Cor Color
PFD0101	Anodizado Anodizado
PFD0103	Preto Mate Negro Mate
PFD0105	Branco Mate Blanco Mate

	TPD8041	
	TPD8042	
	TPD8040	
	TPD9101	
	TPD9102	
	TPD9100	
	TPD9601	
	TPD9602	
	TPD9600	

DIFUSORES

Difusor Semi-Opalino
Difusor Semi Opal

Difusor Opalino
Difusor Opal



DFD3003



DFD3005



DFD4003



DFD4005



DFD4503



DFD4505

PERFIS SALIENTES

PERFIL TIPO Y



Perfil York



Potência máxima | Potencia máxima: 31,5W/mt
 Aplicação | Aplicación: Saliente

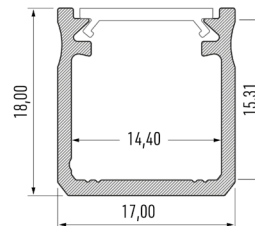

Ref.	Cor Color
PFA131	Anodizado Anodizado
PFA132	Lacado Branco Laca Blanco
PFA137	Não Anodizado No Anodizado
PFA138	Anodizado Preto Anodizado Negro
PFA1310	Champanhe Champán
PFA131.3	Anodizado 3mt Anodizado 3mt

Ref.	Cor Color
TP131	Topo PL Cinza Tapa PL Gris
TP132	Topo PL Branco Tapa PL Blanco
TP138	Topo PL Preto Tapa PL Negro
TPA1310	Topo PL Champanhe Tapa PL Champán
FX13	Fixador Transparente Fijador Transparente
FXM13	Fixador de Metal Fijador de Metal
228421	Fixador Orientável Fijador Orientable

Perfil de alumínio para montagem em superfície.
 Debido à sua altura, obtemos uma luz uniforme e mais focada sem pontos LED visíveis.

Perfil de aluminio para montaje en superficie.
 Por su altura conseguimos una luz uniforme, más focalizada y sin puntos LED visibles.

DIFUSORES

DF1LT DF1LT30 Difusor Lente 15° Difusor Lente 30°	DF1T Difusor Transparente	DF1SOE* Difusor Semi-Opalino Difusor Semi-Opal	DF1F Difusor Fosco Difusor Mate	DF1OE* Difusor Opalino Difusor Opal	DF1PT DF1PT.3 Difusor Preto Difusor Negro
DF2ST Difusor Alto Semi-Transparente	DF2SO Difusor Alto Semi-Opalino Difusor Alto Semi-Opal	DF2O Difusor Alto Opalino Difusor Alto Opal	DF2PT Difusor Alto Preto Difusor Alto Negro		

*Disponível em:
 *Disponible en:

VARA 3m	10m	20m	30m	40m	50m
DF1SOE.3	DF1SOE.10	DF1SOE.20	DF1SOE.30	DF1SOE.40	DF1SOE.50
DF1OE.3	DF1OE.10	DF1OE.20	DF1OE.30	DF1OE.40	DF1OE.50

PERFIS SALIENTES

PERFIL SLIMO



Aplicação | Aplicación:
Saliente ou Suspensão | Saliente o Suspensión

Perfil compacto, adequado para instalação suspensa ou à superfície, com um ângulo de distribuição da luz reduzido e uma classificação de encandeamento unificada (UGR) baixa, minimizando o efeito de incómodo do encandeamento.

Perfil compacto, adecuado para instalación suspendida o en superficie, con un ángulo de distribución de la luz reducida y una clasificación de deslumbramiento unificado (UGR) baja, lo que minimiza el efecto molesto del deslumbramiento.

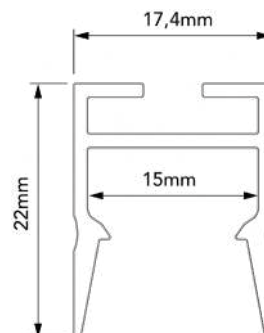

Ref.	Cor Color
PFA1851	Anodizado Anodizado
PFA1852	Lacado Branco Laca Blanco
PFA1858	Anodizado Preto Anodizado Negro

Ref.	Cor Color
TPL1851	Topo Lacado Cinza Tapa Laca Gris
TP1851	Topo PL Cinza Tapa PL Gris
TP1852	Topo PL Branco Tapa PL Blanco
TP1858	Topo PL Preto Tapa PL Negro
FX110	Fixador Metal Fijador Metálico



PERFIS SALIENTES

PERFIL VIDE

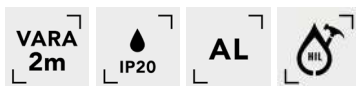
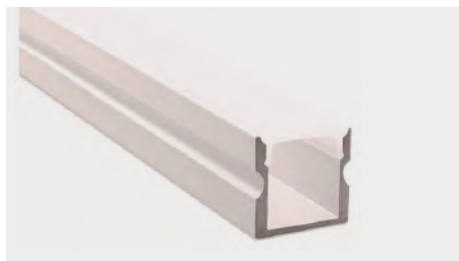

Aplicação | Aplicación: Saliente

Perfil Saliente alto s/ abas
Perfil Saliente alto s/ solapas

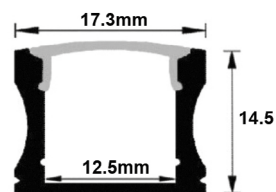

Modelo	Ref.	Cor Color
VIDE	PF102	Anodizado c/ Difusor Semi-Opalino Anodizado c/ Difusor Semi-Opalino
	PFT102	Anodizado c/ Difusor Transparente Anodizado c/ Difusor Transparente

Modelo	Ref.	Cor Color
TORRE DE VIDE	PF11011	Perfil Anodizado sem Difusor Perfil Anodizado sin Difusor
	DF15SO*	Difusor Semi-Opalino Difusor Semi-Opalino

Ref.	Acessórios
TP102	Topo final Tapa final
FX102	Fixador Metal Fijador Metal
FX101	Fixador Metal Fijador Metal

*Disponível em | Disponible en:



DF15SO DF15SO.10 DF15SO.20 DF15SO.50

PERFIL NISA

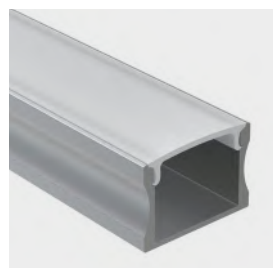

Potência máxima: 31,5W/mt
Potencia máxima: 31,5W/mt
Aplicação | Aplicación: Saliente

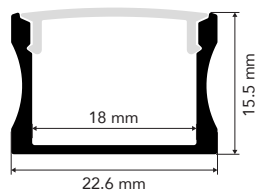

Ref.	Cor Color
PFA1831	Anodizado c/ Difusor Semi-Opalino Anodizado c/ Difusor Semi-Opalino

TP1831	Topo PL Cinza Tapa PL Gris
--------	-------------------------------

PERFIL AVIS



Aplicação | Aplicación: Saliente

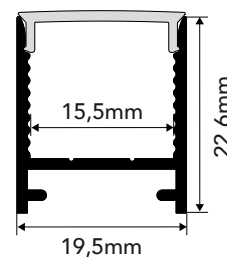

Ref.	Cor Color
PFA1841	Anodizado c/ Difusor Semi-Opalino Anodizado c/ Difusor Semi-Opalino
PFA1848	Anodizado Preto c/ Difusor Semi-Opalino Anodizado Negro c/ Difusor Semi-Opalino

TP1841	Topo PL Cinza Tapa PL Gris
TP1848	Topo PL Preto Tapa PL Negro
FX1841	Fixador de Metal Fijador de Metal

PERFIS SALIENTES

PERFIL DUAL

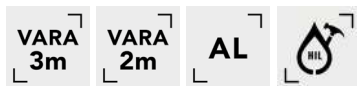

Potência máxima: 22,2W/mt
 Potencia máxima: 22,2W/mt
 Aplicação | Aplicación: Saliente

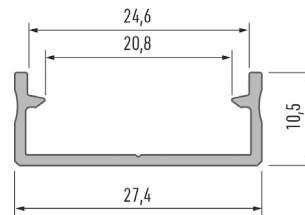

Ref.	Cor Color		
PFA1601	Anodizado Anodizado		TP1601 Topo PL Cinza Tapa PL Gris
PFA1602	Lacado Branco Laca Blanco		TP1602 Topo PL Branco Tapa PL Blanco
PFA1608	Anodizado Preto Anodizado Negro		TP1608 Topo PL Preto Tapa PL Negro
PFA1601.3	Anodizado 3mt Anodizado 3mt		
PFA1602.3	Lacado Branco 3mt Laca Blanco 3mt		
PFA1608.3	Anodizado Preto 3mt Anodizado Negro 3mt		FXM160 Fixador de Metal Fijador de Metal

Perfil de alumínio para montagem em superfície. Devido à sua largura, este perfil de baixa altura, permite a utilização de duas fitas Led.

Perfil de aluminio para montaje en superficie. Debido a su ancho, este perfil de baja altura permite el uso de dos tiras de LED.

DIFUSORES

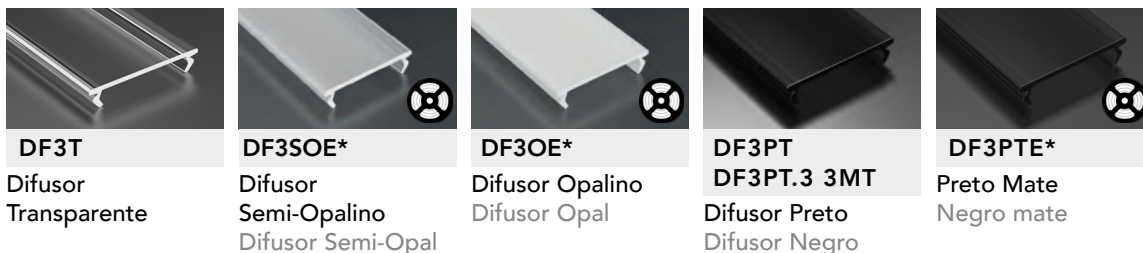

DF3T
Difusor
Transparente

DF3SOE*
Difusor
Semi-Opalino
Difusor Semi-Opal

DF3OE*
Difusor Opalino
Difusor Opal

DF3PT
DF3PT.3 3MT
Difusor Preto
Difusor Negro

DF3PTE*
Preto Mate
Negro mate



*Disponível em:
*Disponible en:

DF3PTE	DF3SOE.3 DF3OE.3	DF3SOE.10 DF3OE.10 DF3PTE.10	DF3SOE.20 DF3OE.20	DF3SOE.30 DF3OE.30	DF3SOE.40 DF3OE.40	DF3SOE.50 DF3OE.50 DF3PTE.50

PERFIS SALIENTES

PERFIL SILEDA



Perfil Saragoça



Potência máxima | Potencia máxima: 36,4W/mt
 Aplicação | Aplicación:
 Suspensão / Saliente | Suspensión / Saliente

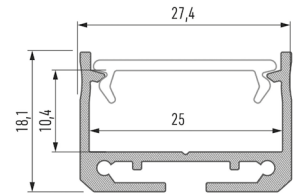

Ref.	Cor Color
PFA191	Anodizado Anodizado
PFA192	Lacado Branco Laca Blanco
PFA198	Lacado Preto Laca Negro
PFA191.3	Anodizado 3mt Anodizado 3mt
PFA192.3	Lacado Branco 3mt Laca Blanco 3mt
PFA198.3	Lacado Preto 3mt Laca Negro 3mt

Ref.	Cor Color
TP191	Topo PL Cinza Tapa PL Gris
TP192	Topo PL Branco Tapa PL Blanco
TP198	Topo PL Preto Tapa PL Negro
TP191AL	Topo AL Cinza Tapa Al Gris
228421	Fixador Orientável Fijador Orientable
FX110	Fixador Metal Fijador metálico

O perfil Saragoça é um perfil de superfície ou suspensão com possibilidade de aplicação de duas tiras de fitas de LED.

El perfil Saragoça es un perfil de superficie o suspensión con posibilidad de aplicar dos tiras de cinta LED.

ACESSÓRIOS DISPONÍVEIS | ACCESORIOS DISPONIBLES

Suspensões para perfil | Suspensiones de perfil



Unões de ligação | Uniones



DIFUSORES

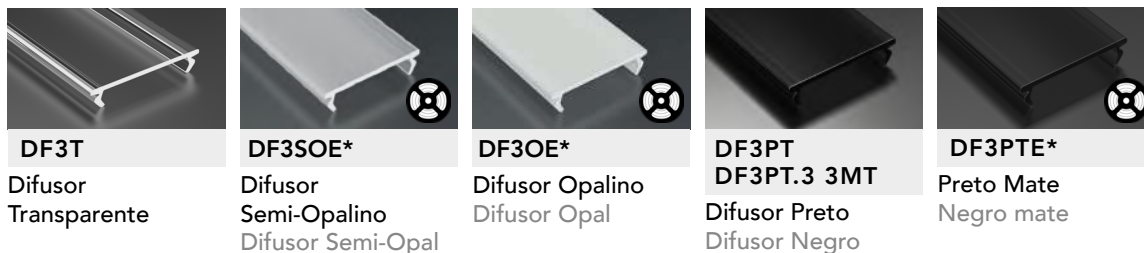

*Disponível em: *Disponible en:

VARA 2m	VARA 3m	10m	20m	30m	40m	50m
DF3PTE	DF3SOE.3 DF3OE.3	DF3SOE.10 DF3OE.10 DF3PTE.10	DF3SOE.20 DF3OE.20	DF3SOE.30 DF3OE.30	DF3SOE.40 DF3OE.40	DF3SOE.50 DF3OE.50 DF3PTE.50

PERFIS SALIENTES

PERFIL AXEL





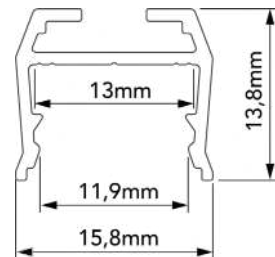

Aplicação | Aplicación: Saliente

Perfil led projetado para retroiluminação decorativa e de destaque em móveis e acabamentos de interiores.

Perfil led diseñado para la retroiluminación decorativa y de resaltado en muebles y acabados de interiores.



Ref.	Cor Color
PFA20991	 Anodizado Anodizado
PFA20992	 Lacado Branco Laca Blanco

Ref.	
 DF140	Difusor Opalino
 TP20992	Topo PL Branco Topo PL Blanco
 TP20991	Topo PL Cinza Topo PL Gris
 FX2099	Fixador de Metal Fijador de Metal



PERFIS SALIENTES

PERFIL DILEDA



Perfil Dublin



Potência máxima | Potencia máxima: 39,2W/mt
 Aplicação | Aplicación:
 Suspensão / Saliente | Suspensión / Saliente

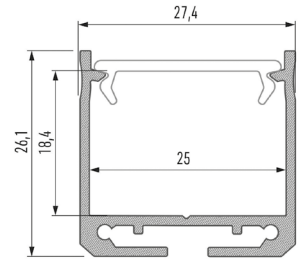

Ref.	Cor Color	Ref.	Cor Color
PFA121	Anodizado Anodizado	TP121	Topo PL Cinza Tapa PL Gris
PFA122	Lacado Branco Laca Blanco	TP122	Topo PL Branco Tapa PL Blanco
PFA128	Lacado Preto Laca Negro	TP121AL	Topo AL Cinza Tapa Al Gris
PFA121.3	Anodizado 3mt Anodizado 3mt	TP128AL	Topo AL Preto Tapa AL Negro
PFA122.3	Lacado Branco 3mt Laca Blanco 3mt	TP128	Topo PL Preto Tapa PL Negro
PFA128.3	Lacado Preto 3mt Laca Negro 3mt	228421	Fixador Orientável Fijador Orientable
		FX110	Fixador Metal Fijador metálico

O perfil Dublin é um perfil de superfície ou suspensão com possibilidade de aplicação de duas tiras de fitas de LED.

El perfil Dublin es un perfil de superficie o suspensión con posibilidad de aplicar dos tiras de cinta LED.

ACESSÓRIOS DISPONÍVEIS | ACCESORIOS DISPONIBLES

Suspensões para perfil | Suspensiones de perfil



228521.125

228521
228521.3 3mt
228521.5 5mt

228521A

Uniãos de ligação | Uniones



228521U

228521UA

228521UA120

228521UT

DIFUSORES

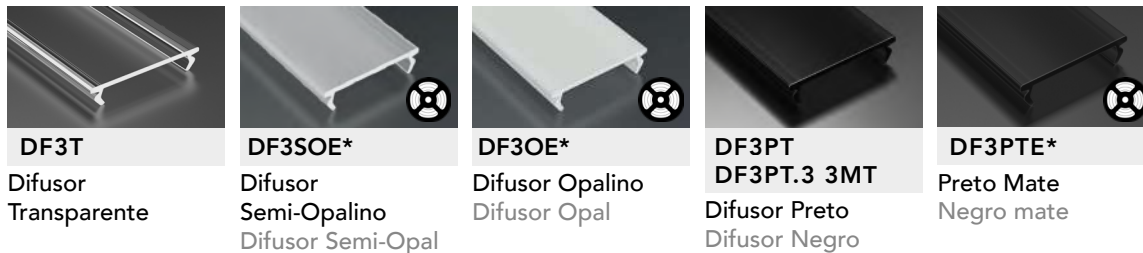

DF3T

Difusor
Transparente

DF3SOE*

Difusor
Semi-Opalino
Difusor Semi-Opal

DF3OE*

Difusor Opalino
Difusor Opal

DF3PT
DF3PT.3 3MT

Difusor Preto
Difusor Negro

DF3PTE*

Preto Mate
Negro mate



*Disponível em:
*Disponible en:

VARA 2m	VARA 3m	10m	20m	30m	40m	50m
DF3PTE	DF3SOE.3 DF3OE.3	DF3SOE.10 DF3OE.10 DF3PTE.10	DF3SOE.20 DF3OE.20	DF3SOE.30 DF3OE.30	DF3SOE.40 DF3OE.40	DF3SOE.50 DF3OE.50 DF3PTE.50

PERFIS SALIENTES

PERFIL ALBA



Aplicação | Aplicación:
Saliente ou Suspensão | Saliente o Suspensión

Solução para superfície ou suspenso proporcionando uma linha de luz ainda mais uniforme graças à colocação mais profunda.

Solución para superficie o suspendida que proporciona una línea de luz aún más uniforme gracias a su colocación más profunda.

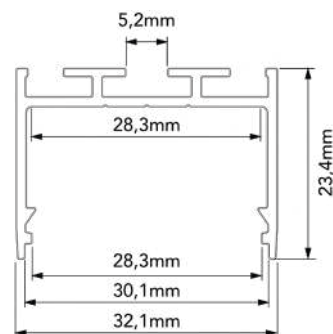

Ref.	Cor Color
PFA201001	Anodizado Anodizado
PFA201002	Branco Blanco
PFA201008	Preto Negro

Ref.	Ref.	Cor Color
	DF130	Difusor Opalino
	DF13PT	Difusor Preto Difusor Negro
	TP201008	Topo PL Preto Topo PL Negro
	TP201002	Topo PL Branco Topo PL Blanco

PERFIL SOLIS



Potência máxima | Potencia máxima: 33,9W/mt
Aplicação | Aplicación:
Suspensão / Saliente | Suspensión / Saliente

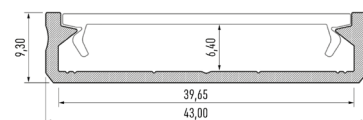

Ref.	Cor Color
PFA1251	Anodizado Anodizado
PFA1252	Lacado Branco Laca Blanco
PFA1257	Não Anodizado No Anodizado

Ref.	Cor Color
	TP1251 Topo PL Cinza Tapa PL Gris
	TP1252 Topo PL Branco Tapa PL Blanco

ACESSÓRIOS DISPONÍVEIS | ACCESORIOS DISPONIBLES

Suspensões para perfil | Suspensiones de perfil

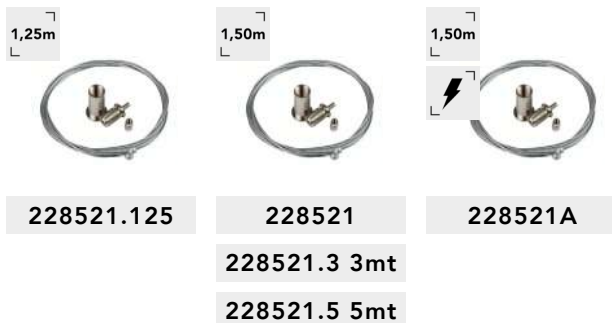

228521.125

228521

228521A

228521.3 3mt

228521.5 5mt

DIFUSORES

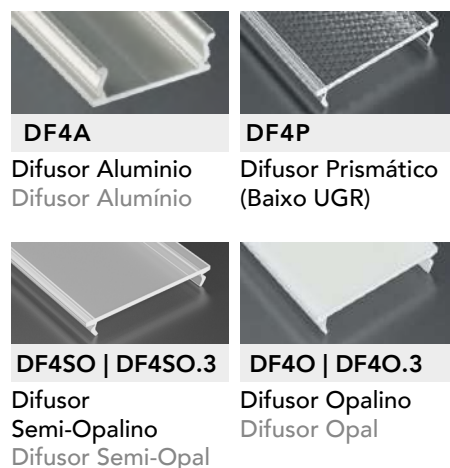

DF4A
Difusor Alumínio
Difusor Aluminio

DF4P
Difusor Prismático
(Baixo UGR)

DF4SO | DF4SO.3
Difusor Semi-Opalino
Difusor Semi-Opal

DF40 | DF40.3
Difusor Opalino
Difusor Opal

PERFIS SALIENTES

PERFIL ILEDO



Perfil Ílhavo



Potência máxima | Potencia máxima: 70,5W/mt
 Aplicação | Aplicación:
 Suspensão / Saliente | Suspensión / Saliente

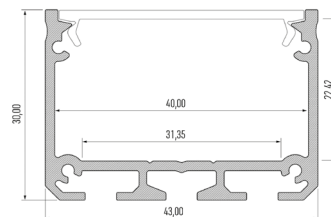

Ref.	Cor Color
PFA151	Anodizado Anodizado
PFA152	Lacado Branco Laca Blanco
PFA158	Lacado Preto Laca Negro
PFA151.3	Anodizado 3mt Anodizado 3mt
PFA152.3	Anodizado Branco 3mt Anodizado Blanco 3mt
PFA158.3	Lacado Preto 3mt Anodizado Negro 3mt

Ref.	Cor Color
TP151	Topo PL Cinza Tapa PL Gris
TP152	Topo PL Branco Tapa PL Blanco
TP158	Topo PL Preto Tapa PL Negro
TP151AL	Topo AL Cinza Tapa AL Gris
TPF152AL	Topo AL Branco Tapa AL Blanco
TP158AL	Topo AL Preto Tapa AL Preto
TPF151	Topo PL Cinza Tapa PL Gris

O perfil Ílhavo destina-se ao uso em superfície e também como elemento de iluminação suspensa.

El perfil Ílhavo está destinado a su uso en superficie y también como elemento de iluminación suspendido.

ACESSÓRIOS DISPONÍVEIS | ACCESORIOS DISPONIBLES

Suspensões para perfil | Suspensiones de perfil

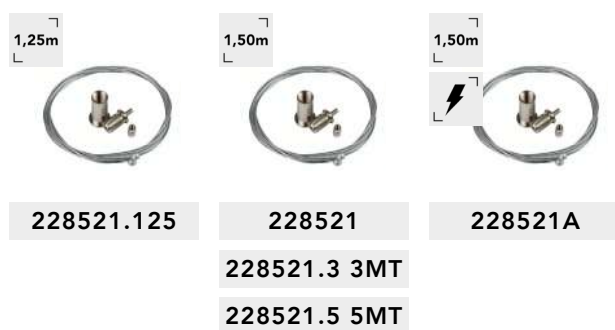

228521.125

228521

228521A

228521.3 3MT

228521.5 5MT

Unões de ligação | Uniones



228521U

228521UA

228521UT

228521UA120

DIFUSORES



DF4LM

Difusor de Lamelas
Difusor de Láminas

DF4A

Difusor Aluminio
Difusor Aluminio

DF4P

Difusor Prismático
(Baixo UGR)

DF4SO | DF4SO.3

Difusor Semi-Opalino
Difusor Semi-Opal

DF4O | DF4O.3

Difusor Opalino
Difusor Opal

PERFIS SALIENTES

PERFIL LARGO



Potência máxima | Potencia máxima: 126W/mt
 Aplicação | Aplicación:
 Suspensão / Saliente | Suspensión / Saliente

Ref.	Cor Color
PFA1291	Anodizado Anodizado
PFA1292	Lacado Branco Laca Blanco

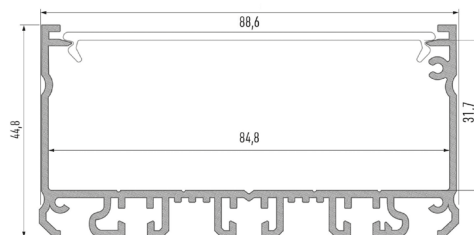

	TP1291	Topo AL Cinza Tapa AL Gris
	TP1292	Topo AL Branco Tapa AL Blanco

Perfil saliente que pode suportar até 6 fitas de led em paralelo.

Perfil saliente que puede soportar hasta 6 tiras LED en paralelo.

ACESSÓRIOS DISPONÍVEIS | ACCESORIOS DISPONIBLES

Suspensões para perfil | Suspensiones de perfil

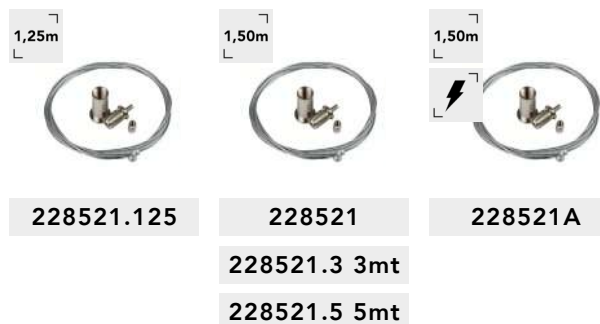

228521.125

228521

228521A

228521.3 3mt

228521.5 5mt

Unões de ligação | Uniones



228521U

228521UA

228521UT

228521UA120

DIFUSORES

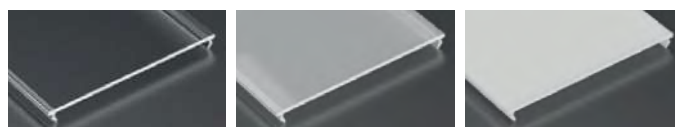

DF11T

DF11SO

DF11O

Difusor
Transparente

Difusor
Semi-Opalino
Difusor Semi-Opal

Difusor Opalino
Difusor Opal

PERFIS SALIENTES

PERFIL TIPO C



Perfil Copenhaga



Potência máxima | Potencia máxima: 23,5W/mt
 Aplicação | Aplicación:
 Saliente de Canto | Saliente de Esquina

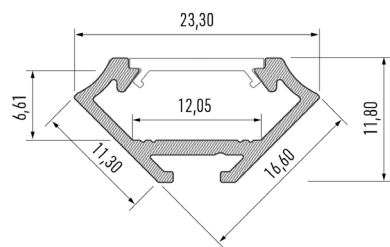

Ref.	Cor Color
PFA671	Anodizado Anodizado
PFA672	Lacado Branco Laca Blanco
PFA677	Não Anodizado No Anodizado
PFA678	Anodizado Preto Anodizado Negro
PFA6710	Champanhe Champán
PFA671.3	Anodizado 3mt Anodizado 3mt
PFA672.3	Lacado Branco 3mt Laca Blanco 3mt
PFA678.3	Anodizado Preto 3mt Anodizado Negro 3mt



Ref.	Cor Color
TP671	Topo PL Cinza Tapa PL Gris
TP672	Topo PL Branco Tapa PL Blanco
TP678	Topo PL Preto Tapa PL Negro
TP6710	Topo PL Champanhe Tapa PL Champán
FX67	Fixador Transparente Fijador Transparente
FXM67	Fixador de Metal Fijador de Metal
228421	Fixador Orientável Fijador Orientable

Perfil com ângulo de inclinação de 45°. Perfeito para conexões de design de duas superfícies perpendiculares.

Perfil con ángulo de inclinación de 45°. Perfecto para conexiones de diseño de dos superficies perpendiculares.

DIFUSORES



DF1LT DF1LT30	DF1T	DF1SOE*	DF1F	DF1OE*	DF1PT
Difusor Lente 15° Difusor Lente 30°	Difusor Transparente	Difusor Semi-Opalino Difusor Semi-Opal	Difusor Fosco Difusor Mate	Difusor Opalino Difusor Opal	Difusor Preto Difusor Negro



*Disponível em:
*Disponible en:



DF1SOE.3	DF1SOE.10	DF1SOE.20	DF1SOE.30	DF1SOE.40	DF1SOE.50
DF1OE.3	DF1OE.10	DF1OE.20	DF1OE.30	DF1OE.40	DF1OE.50

PERFIL ARRAIOLOS

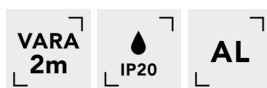
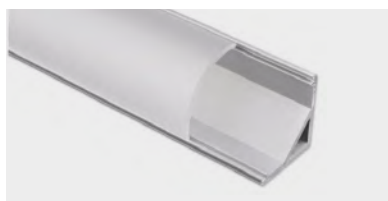

Aplicação | Aplicación:
 Saliente de Canto | Saliente de Esquina

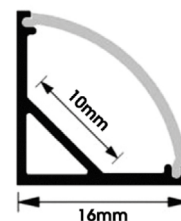

Modelo	Ref.	Cor Color
ARRAIOLOS	PF105	Anodizado / Difusor Semi-Opalino Anodizado / Difusor Semi-Opalino

Ref.	Acessórios
TP105	Topo final Tapa final
FX105	Fixador Metal Fijador Metal

PERFIS SALIENTES

PERFIL ALBUFEIRA



VARA 2m AL

Aplicação | Aplicación:
Saliente de Canto | Saliente de Esquina

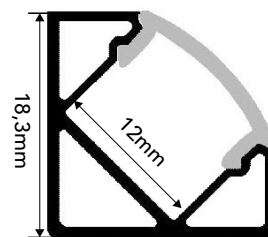

Ref.	Cor Color
PF104	Anodizado c/ Difusor Semi-Opalino Anodizado c/ Difusor Semi-Opalino

TP104	Topo PL Cinza Tapa PL Gris.
-------	--------------------------------

PERFIL TIPO H



VARA 2m AL

Potência máxima | Potencia máxima: 31W/mt
Aplicação | Aplicación:
Saliente de Canto | Saliente de Esquina

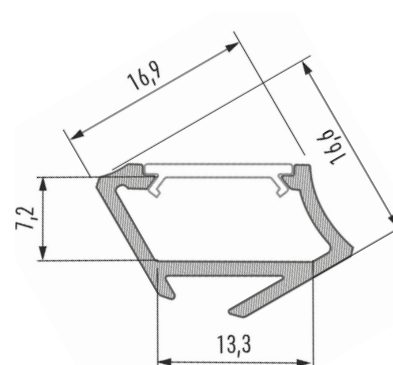

Ref.	Cor Color
PFA6381	Anodizado Anodizado
PFA6382	Lacado Branco Laca Blanco

Perfil de canto Lumines H com ângulo de 30°/60° para iluminação de cozinhas, armários e escadas. Perfil angular Lumines H com ângulo de 30°/60° para iluminação de cocinas, armarios y escalera.

Ref.	Cor Color
TP6381D	Topo PL Cinza Dir. Tapa PL Gris Dcha.
TP6381E	Topo PL Cinza Esq. Tapa PL Gris Izq.
TP6382D	Topo PL Branco Dir. Tapa PL Blanco Dcha.
TP6382E	Topo PL Branco Esq. Tapa PL Blanco Izq.
FX67	Fixador Transparente Fijador Transparente
FXM67	Fixador de Metal Fijador de Metal
228421	Fixador Orientável Fijador Orientable

DIFUSORES

DF1LT DF1LT30	DF1T	DF1SOE*	DF1F	DF10*	DF1PT
Difusor Lente 15° Difusor Lente 30°	Difusor Transparente	Difusor Semi-Opalino Difusor Semi-Opal	Difusor Fosco Difusor Mate	Difusor Opalino Difusor Opal	Difusor Preto Difusor Negro



*Disponível em:
*Disponible en:

VARA 3m	10m	20m	30m	40m	50m
---------	-----	-----	-----	-----	-----

DF1SOE.3	DF1SOE.10	DF1SOE.20	DF1SOE.30	DF1SOE.40	DF1SOE.50
DF1OE.3	DF1OE.10	DF1OE.20	DF1OE.30	DF1OE.40	DF1OE.50

PERFIS SALIENTES

PERFIL ALCOUTIM

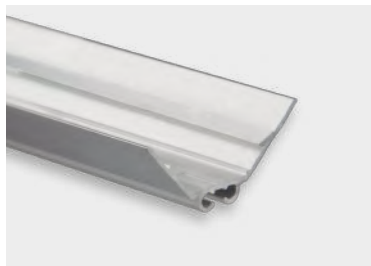

VARA 2m AL

Aplicação | Aplicación:
Saliente de Canto
Saliente de Esquina



Ref.	Cor Color
PFG23100	Anodizado Anodizado

	TPG23150	Topo AL Cinza Tapa AL Gris
--	----------	-------------------------------

	DFG00097	Difusor Semi-Opalino Difusor Semi-Opal
--	----------	---

	DFG00098	Difusor Opalino Difusor Opal
--	----------	---------------------------------



PERFIL ALCOBAÇA



VARA 2m IP20 AL NOVO

Aplicação | Aplicación:
Saliente de Canto
Saliente de Esquina

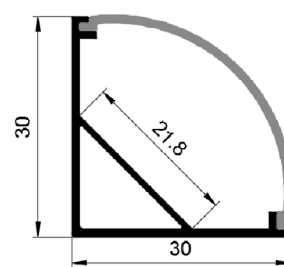

Ref.	Cor Color
PFA6891	Anodizado c/ Difusor Semi-Opalino Anodizado c/ Difusor Semi-Opalino

Ref.	Cor Color
TP6891	Topo Canto PL Cinza Topo Canto PL Cinza
TPF6891	Topo Canto PL Cinza Topo Canto PL Cinza
FX6891	Fixador Plástico Fijador Plástico

PERFIS SALIENTES

PERFIL ESPORÃO



Aplicação | Aplicación:
Saliente de Canto
Saliente de Esquina

PERFIL JUROMENHA



Potência máxima | Potencia máxima:
31W/mt
Aplicação | Aplicación:
Saliente de Canto | Saliente de Esquina

Ref.	Cor Color
PFD0570	Anodizado Anodizado

Ref.	Cor Color
PFG02044	Anodizado Anodizado

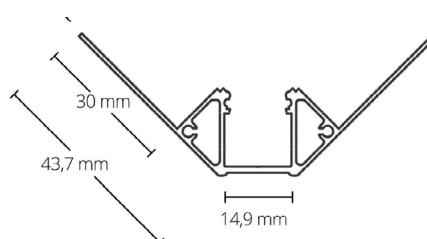
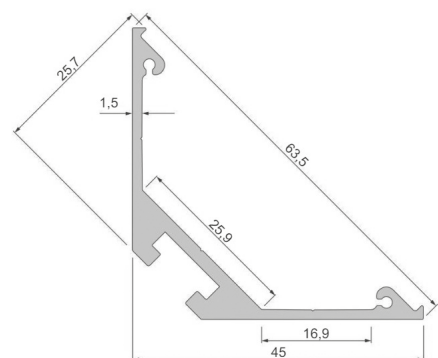

	TPD8390	Topo AL Cinza Tapa AL Gris
	TPD9780	Topo AL Cinza Tapa AL Gris
	TPD0570	Topo AL Cinza Tapa AL Gris
	DFD3120	Difusor Opalino Difusor Opal
	DFD4590	Difusor Opalino Difusor Opal
	DFD5590	Difusor Opalino Difusor Opal

	TPG023015	Topo Cinza Tapa Gris
	DFG00004	Difusor Semi-Opalino Difusor Semi-Opal
	DFG00154	Difusor Opalino Difusor Opal
	DFG00070	Difusor Preto Difusor Negro
	DFG00065	Difusor Protetor 5mt Difusor Protector 5mt

Difusor técnico de obra reutilizável para proteção do perfil durante a montagem.
Difusor de obra técnica reutilizable para la protección de perfiles durante el montaje.





Com os perfis de alumínio de encastre obtemos uma aplicação da luz à face da superfície aplicada com a vantagem de ocultar quase todo o alumínio que serve de apoio à aplicação da fita Led. Estes perfis dispõem de uma pequena aba para um melhor acabamento da superfície aplicada.

Con los perfiles de aluminio empotrados conseguimos una aplicación de luz a la cara de la superficie aplicada con la ventaja de ocultar casi todo el aluminio que soporta la aplicación de la tira LED. Estos perfiles tienen una pequeña solapa para un mejor acabado de la superficie aplicada.

PERFIS DE ENCASTRE

Perfiles de Empotrar

PERFIS ENCASTRE

PERFIL BELVER



Aplicação | Aplicación:
Encastre
Empotrar

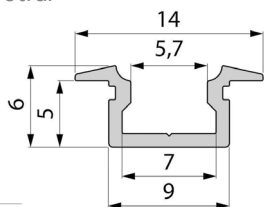

Ref.	Cor Color
PFD5081	Anodizado Anodizado
PFD5083	Preto Mate Negro Mate
PFD5085	Branco Mate Blanco Mate

DIFUSORES

	TPD8681	Topo Cinza Tapa Gris
	TPD8682	Topo Preto Tapa Negro
	TPD8680	Topo Branco Tapa Blanco



DFD3555
Difusor Opalino
Difusor Opal

	TPD9181	Topo Cinza Tapa Gris
	TPD9182	Topo Preto Tapa Negro
	TPD9180	Topo Branco Tapa Blanco



DFD4055
Difusor Opalino
Difusor Opal

	TPD9681	Topo Cinza Tapa Gris
	TPD9682	Topo Preto Tapa Negro
	TPD9680	Topo Branco Tapa Blanco



DFD4555
Difusor Opalino
Difusor Opal



PERFIS ENCASTRE

PERFIL TIPO Z



Potência máxima
Potencia máxima: 21W/mt
Aplicação | Aplicación:
Encastrar | Empotrar

PERFIL TIPO B Perfil Berlim



Potência máxima | Potencia máxima:
22,5W/mt
Aplicação | Aplicación:
Encastrar | Empotrar

Ref.	Cor Color
PFA2191	Anodizado Anodizado
PFA2192	Lacado Branco Laca Blanco
PFA2197	Não Anodizado No Anodizado
PFA2198	Anodizado Preto Anodizado Negro
PFA2198.3	Anodizado Preto 3mt Anodizado Negro 3mt

Ref.	Cor Color
PFA2171	Anodizado Anodizado
PFA2172	Lacado Branco Laca Blanco
PFA2177	Não Anodizado No Anodizado
PFA2178	Anodizado Preto Anodizado Negro
PFA21710	Champanhe Champán
PFA2171.3	Anodizado 3mt Anodizado 3mt
PFA2172.3	Lacado Branco 3mt Laca Blanco 3mt
PFA2177.3	Não Anodizado 3mt No Anodizado 3mt
PFA21710.3	Champanhe 3mt Champán 3mt

	TP2191	Topo PL Cinza Tapa PL Gris
	TP2192	Topo PL Branco Tapa PL Blanco
	TP2198	Topo PL Preto Tapa PL Negro

	TP2171	Topo PL Cinza Tapa PL Gris
	TP2172	Topo PL Branco Tapa PL Blanco
	TP2178	Topo PL Preto Tapa PL Negro
	TPR21710	Topo PL Champanhe Tapa PL Champán
	TPR2171	Topo PL Cinza Tapa PL Gris
	TPR2178	Topo PL Preto Tapa PL Negro

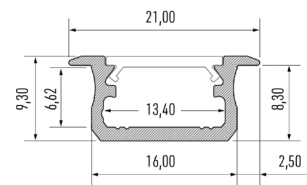
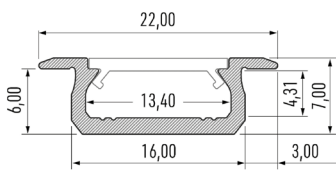

DIFUSORES



DF1LT | DF1LT30
Difusor Lente 15°
Difusor Lente 30°

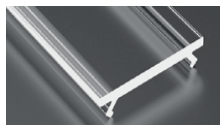

DF1T
Difusor
Transparente



DF1SOE*
Difusor Semi-Opal
Difusor Semi-Opal

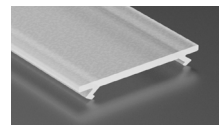

DF1F
Difusor Fosco
Difusor Mate



DF1OE*
Difusor Opalino
Difusor Opal

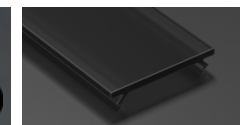

DF1PT | DF1PT.3
Difusor Preto
Difusor Negro



*Disponível em:
*Disponible en:



DF1SOE.3 DF1SOE.10 DF1SOE.20 DF1SOE.30 DF1SOE.40 DF1SOE.50
DF1OE.3 DF1OE.10 DF1OE.20 DF1OE.30 DF1OE.40 DF1OE.50

PERFIS ENCASTRE

PERFIL ESTREMOZ



Aplicação | Aplicación: Encastre | Empotrado

Perfil de Encastre baixo c/ abas
Perfil empotrado bajo c/ solapas

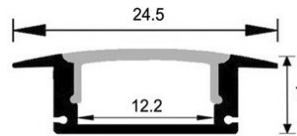

Modelo	Ref.	Cor Color
ESTREMOZ	PF201	Anodizado c/ Difusor Semi-Opalino Anodizado c/ Difusor Semi-Opalino
	PFT201	Anodizado c/ Difusor Transparente Anodizado c/ Difusor Transparente

Ref.	Acessórios
TP201	Topo final Tapa final

Modelo	Ref.	Cor Color
TORRE DE ESTREMOZ	PFA21401	Perfil Anodizado sem Difusor Perfil Anodizado sin Difusor
	DF15SO*	Difusor Semi-Opalino Difusor Semi-Opalino

*Disponível em | Disponible en:



PERFIS ENCASTRE

PERFIL TIPO U



VARA 3m
VARA 2m
AL
CORTE 16mm

Potência máxima
 Potencia máxima: 32,8W/mt
 Aplicação | Aplicación:
 Encastrar | Empotrar

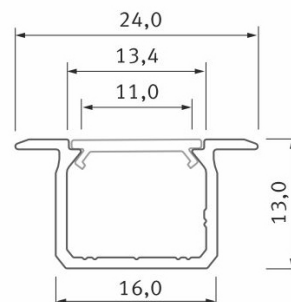

Ref.	Cor Color
PFA2741	Anodizado Anodizado
PFA2742	Lacado Branco Laca Blanco
PFA2747	Não Anodizado No Anodizado
PFA2748	Anodizado Preto Anodizado Negro
PFA2741.3	Anodizado 3mt Anodizado 3mt
PFA2742.3	Lacado Branco 3mt Laca Blanco 3mt
PFA2747.3	Não Anodizado 3mt No Anodizado 3mt
PFA2748.3	Anodizado Preto 3mt Anodizado Negro 3mt



TPF2741	Topo PL Cinza Tapa PL Gris
TPF2742	Topo PL Branco Tapa PL Blanco
TPF2748	Topo PL Preto Tapa PL Negro

DIFUSORES



DF1LT | DF1LT30
 Difusor Lente 15°
 Difusor Lente 30°



DF1T
 Difusor
 Transparente

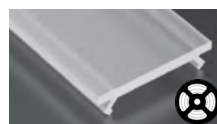

DF1SOE*
 Difusor
 Semi-Opalino
 Difusor Semi-Opal

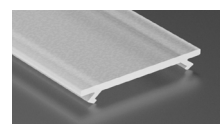

DF1F
 Difusor Fosco
 Difusor Mate



DF1O*
 Difusor Opalino
 Difusor Opal

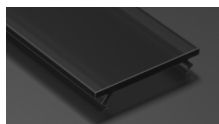

DF1PT | DF1PT.3
 Difusor Preto
 Difusor Negro

*Disponível em:
 *Disponible en:

VARA 3m
10m
20m
30m
40m
50m

DF1SOE.3 DF1SOE.10 DF1SOE.20 DF1SOE.30 DF1SOE.40 DF1SOE.50
 DF1OE.3 DF1OE.10 DF1OE.20 DF1OE.30 DF1OE.40 DF1OE.50

PERFIS ENCASTRE

PERFIL MANGANCHA

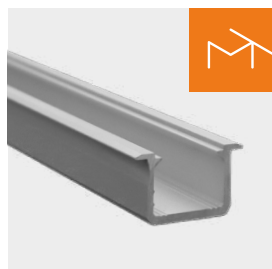

Potência máxima
Potencia máxima: 33,1W/mt
Aplicação | Aplicación:
Encastrar | Empotrar

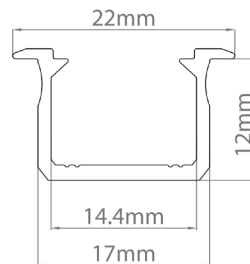

Ref.	Cor Color
PFA2471	Anodizado Anodizado
PFA2472	Lacado Branco Laca Blanco
PFA2477	Não Anodizado No Anodizado
PFA2478	Lacado Preto Laca Negro
PFA2471.3	Anodizado 3mt Anodizado 3mt
PFA2472.3	Lacado Branco 3mt Laca Blanco 3mt
PFA2477.3	Não Anodizado 3mt No Anodizado 3mt
PFA2478.3	Lacado Preto 3mt Laca Negro 3mt

Ref.	Cor Color
TP2471	Topo PL Cinza Tapa PL Gris
TP2472	Topo PL Branco Tapa PL Blanco
TP2478	Topo PL Preto Tapa PL Negro



Perfil de encastrar desenhado para ser aplicado entre placas de gesso com 13 mm de espessura.

Perfil de empotrar diseñado para ser aplicado entre placas de yeso de 13 mm de espesor.

* Possibilidade de fornecimento em 4 e 6 metros.

* Posibilidad de suministro en 4 y 6 metros.

DIFUSORES



DF1LT | DF1LT30
Difusor Lente 15°
Difusor Lente 30°

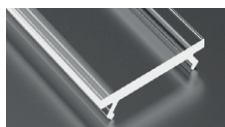

DF1T
Difusor
Transparente



DF1SOE*
Difusor
Semi-Opalino
Difusor Semi-Opal

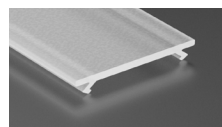

DF1F
Difusor Fosco
Difusor Mate



DF1OE*
Difusor Opalino
Difusor Opal

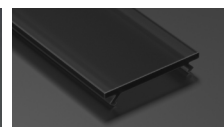

DF1PT | DF1PT.3
Difusor Preto
Difusor Negro



*Disponível em:
*Disponibile en:



DF1SOE.3 DF1SOE.10 DF1SOE.20 DF1SOE.30 DF1SOE.40 DF1SOE.50
DF1OE.3 DF1OE.10 DF1OE.20 DF1OE.30 DF1OE.40 DF1OE.50

PERFIS ENCASTRE

PERFIL TIPO G



Perfil Granada



Potência máxima
Potencia máxima: 32,5W/mt
Aplicação | Aplicación:
Encastrar | Empotrar

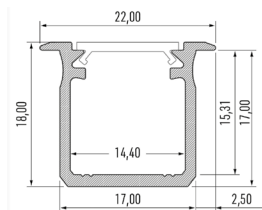

Ref.	Cor Color
PFA2181	Anodizado Anodizado
PFA2182	Lacado Branco Laca Blanco
PFA2187	Não Anodizado No Anodizado
PFA2188	Anodizado Preto Anodizado Negro
PFA2181.3	Anodizado 3mt Anodizado 3mt

Ref.	Cor Color
TP2181	Topo PL Cinza Tapa PL Gris
TP2182	Topo PL Branco Tapa PL Blanco
TP2188	Topo PL Preto Tapa PL Negro

Perfil de alumínio para montagem de encastre. Devido à sua altura, obtemos uma luz uniforme e mais focada sem pontos LED visíveis. O perfil proporciona uma luminária discreta de fitas LED e é perfeitamente adequado para iluminação decorativa em móveis e acabamentos interiores.

Perfil de aluminio para empotrar. Por su altura conseguimos una luz uniforme, más focalizada y sin puntos LED visibles. El perfil proporciona una luminaria de tira LED discreta y se adapta perfectamente a iluminación decorativa en muebles y acabados de interiores.

DIFUSORES



DF1LT | DF1LT30
Difusor Lente 15°
Difusor Lente 30°

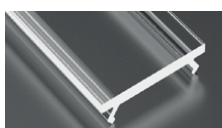

DF1T
Difusor
Transparente



DF1SOE*
Difusor
Semi-Opalino
Difusor Semi-Opal

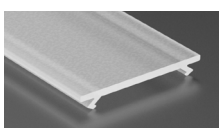

DF1F
Difusor Fosco
Difusor Mate

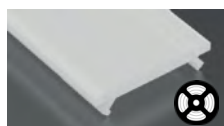

DF1OE*
Difusor Opalino
Difusor Opal

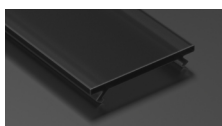

DF1PT | DF1PT.3
Difusor Preto
Difusor Negro



*Disponível em:
*Disponible en:



DF1SOE.3 DF1SOE.10 DF1SOE.20 DF1SOE.30 DF1SOE.40 DF1SOE.50
DF1OE.3 DF1OE.10 DF1OE.20 DF1OE.30 DF1OE.40 DF1OE.50

PERFIS ENCASTRE

PERFIL TIPO W



Potência máxima
Potencia máxima: 33,1W/mt
Aplicação | Aplicación:
Encastrar | Empotrar

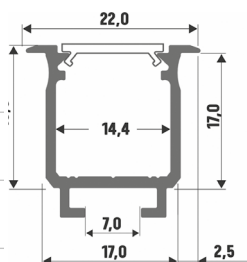

Ref.	Cor Color
PFA2421	Anodizado Anodizado
PFA2422	Lacado Branco Laca Blanco
PFA2428	Anodizado Preto Anodizado Negro

	TP2421	Topo AL Cinza Tapa AL Gris
	TP2422	Topo AL Branco Tapa AL Blanco

Perfil de encastrar que dá uma luz uniforme e mais focada sem pontos de LED visíveis, com a vantagem de usar molas na sua fixação.

Perfil de empotrar que proporciona una luz uniforme y más focalizada sin puntos LED visibles, con la ventaja de utilizar muelles para su fijación.

PERFIL TIPO J



Potência máxima
Potencia máxima: 33,1W/mt
Aplicação | Aplicación:
Encastrar | Empotrar

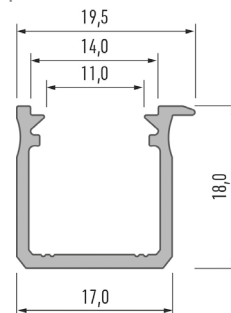

Ref.	Cor Color
PFA1591	Anodizado Anodizado
PFA1592	Lacado Branco Laca Blanco

	TP1591D	Topo PL Cinza c/ furo Dir. Tapa PL Gris c/ pasacable Dcho.
	TP1591E	Topo PL Cinza c/ furo Esq. Tapa PL Gris c/ pasacable Izq.
	TP1592D	Topo PL Branco c/ furo Dir. Tapa PL Blanco c/ pasacable Dcho.
	TP1592E	Topo PL Branco c/ furo Esq. Tapa PL Blanco c/ pasacable Izq.

Perfil com uma aba para encastrar junto à parede e realizar um varrimento de luz.

Perfil con aleta para empotrar en la pared y crear una línea de luz

ACESSÓRIOS DISPONÍVEIS | ACCESORIOS DISPONIBLES

Unões de ligação | Uniones



Molas para perfil
Clip metálico

228521U 228521UA 228521UT 228521UA120 228522

DIFUSORES



DF1LT | DF1LT30
Difusor Lente 15°
Difusor Lente 30°



DF1T
Difusor
Transparente

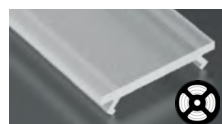

DF1SOE*
Difusor
Semi-Opalino
Difusor Semi-Opal

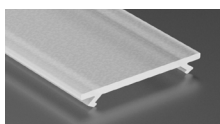

DF1F
Difusor Fosco
Difusor Mate



DF1OE*
Difusor Opalino
Difusor Opal

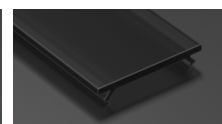

DF1PT | DF1PT.3
Difusor Preto
Difusor Negro



*Disponível em:
*Disponible en:



DF1SOE.3 DF1SOE.10 DF1SOE.20 DF1SOE.30 DF1SOE.40 DF1SOE.50
DF1OE.3 DF1OE.10 DF1OE.20 DF1OE.30 DF1OE.40 DF1OE.50

PERFIS ENCASTRE

PERFIL inSILEDA



Perfil Sevilha



Potência máxima
Potencia máxima: 37,8W/mt
Aplicação | Aplicación:
Encastrar | Empotrar

Difusor recolhido
Difusor empotrado

Ref.	Cor Color
PFA2101	Anodizado Anodizado
PFA2102	Lacado Branco Laca Blanco
PFA2101.3	Anodizado 3mt Anodizado 3mt
PFA2102.3	Lacado Branco 3mt Laca Blanco 3mt

Ref.	Cor Color
TP2101	Topo PL Cinza Tapa PL Gris
TP2102	Topo PL Branco Tapa PL Blanco
TP2101AL	Topo AL Branco Tapa AL Blanco
TP2108	Topo PL Preto Tapa PL Negro

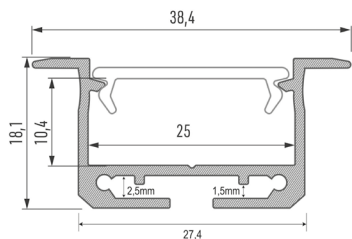

Este é um perfil de encastrar idealizado para uso no teto ou parede. Permite a utilização de duas fitas de Led em paralelo.

Se trata de un perfil de empotrar diseñado para su uso en techo o pared. Permite el uso de dos tiras de LED en paralelo.

ACESSÓRIOS DISPONÍVEIS | ACCESORIOS DISPONIBLES

Unões de ligação | Uniones



DIFUSORES

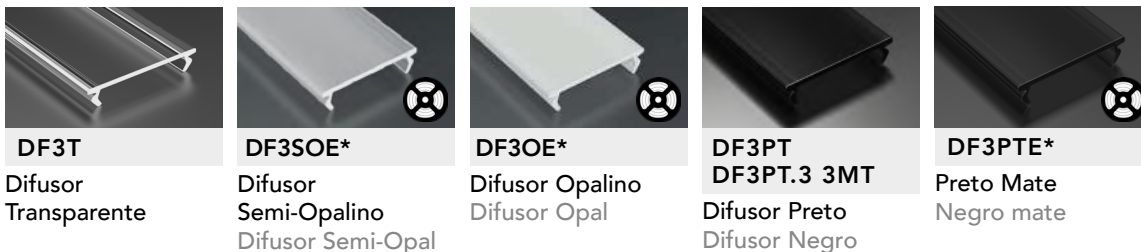

*Disponível em: *Disponible en:

VARA 2m	VARA 3m	10m	20m	30m	40m	50m
DF3PTE	DF3SOE.3 DF3OE.3	DF3SOE.10 DF3OE.10	DF3SOE.20 DF3OE.20	DF3SOE.30 DF3OE.30	DF3SOE.40 DF3OE.40	DF3SOE.50 DF3OE.50 DF3PTE.50

PERFIS ENCASTRE

PERFIL PENEGACHE



VARA 3m VARA 2m AL CORTE 27,4mm

Potência máxima
Potencia máxima: 37,8W/mt
Aplicação | Aplicación:
Encastrar | Empotrar

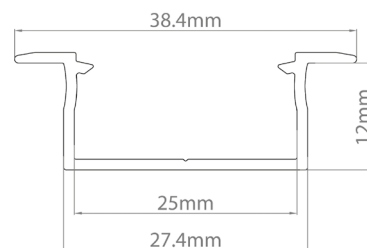

Ref.	Cor Color
PFA2461	Anodizado Anodizado
PFA2462	Lacado Branco Laca Blanco
PFA2468	Lacado Preto Laca Negro
PFA2461.3	Anodizado 3mt Anodizado 3mt
PFA2462.3	Lacado Branco 3mt Laca Blanco 3mt
PFA2468.3	Lacado Preto 3mt Laca Negro 3mt



Difusor à face do perfil
Difusor facial del perfil



Perfil de encastrar desenhado para ser aplicado entre placas de gesso com 13 mm de espessura com possibilidade de aplicação de duas fitas de led.

Perfil de empotrar diseñado para ser aplicado entre placas de yeso laminado de 13 mm de espesor con posibilidad de aplicar dos tiras LED.

* Possibilidade de fornecimento em 4 e 6 metros.
* Posibilidad de suministro en 4 y 6 metros.

DIFUSORES

DF3T Difusor Transparente	DF3SOE* Difusor Semi-Opalino Difusor Semi-Opal	DF3OE* Difusor Opalino Difusor Opal	DF3PT DF3PT.3 3MT Difusor Preto Difusor Negro	DF3PTE* Preto Mate Negro mate

*Disponível em: *Disponible en:

VARA 2m	VARA 3m	10m	20m	30m	40m	50m
DF3PTE	DF3SOE.3 DF3OE.3	DF3SOE.10 DF3OE.10 DF3PTE.10	DF3SOE.20 DF3OE.20	DF3SOE.30 DF3OE.30	DF3SOE.40 DF3OE.40	DF3SOE.50 DF3OE.50 DF3PTE.50

PERFIS ENCASTRE

PERFIL GEMI



VARA 3m
VARA 2m
AL
CORTE 27,2mm

Potência máxima
 Potencia máxima: 30,7W/mt
 Aplicação | Aplicación:
 Encastrar | Empotrar

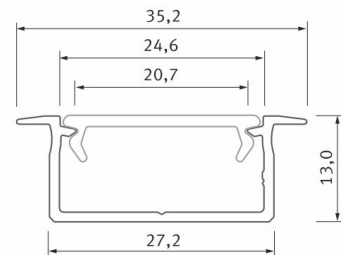

Ref.	Cor Color
PFA2751	Anodizado Anodizado
PFA2752	Lacado Branco Laca Blanco
PFA2757	Não Anodizado No Anodizado
PFA2758	Anodizado Preto Anodizado Negro
PFA2751.3	Anodizado 3mt Anodizado 3mt
PFA2752.3	Lacado Branco 3mt Laca Blanco 3mt
PFA2757.3	Não Anodizado 3mt No Anodizado 3mt
PFA2758.3	Anodizado Preto 3mt Anodizado Negro 3mt

	TPF2751	Topo PL Cinza Tapa PL Gris
	TPF2752	Topo PL Branco Tapa PL Blanco
	TPF2758	Topo PL Preto Tapa PL Negro

Este é um perfil de encastrar idealizado para uso no teto ou parede. Permite a utilização de duas fitas de Led em paralelo.

Se trata de un perfil de empotrar diseñado para su uso en techo o pared. Permite el uso de dos tiras de LED en paralelo.

DIFUSORES

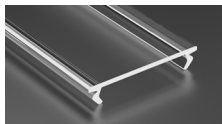

DF3T
Difusor
Transparente

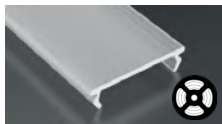

DF3SOE*
Difusor
Semi-Opalino
Difusor Semi-Opal



DF3OE*
Difusor Opalino
Difusor Opal



DF3PT
DF3PT.3 3MT
Difusor Preto
Difusor Negro

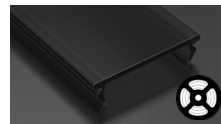

DF3PTE*
Preto Mate
Negro mate



*Disponível em:
*Disponible en:

VARA 2m	VARA 3m	10m	20m	30m	40m	50m
DF3PTE	DF3SOE.3	DF3SOE.10	DF3SOE.20	DF3SOE.30	DF3SOE.40	DF3SOE.50
	DF3OE.3	DF3OE.10	DF3OE.20	DF3OE.30	DF3OE.40	DF3OE.50
		DF3PTE.10				DF3PTE.50

PERFIS ENCASTRE

PERFIL inDILEDA



Perfil Dakar



Potência máxima
Potencia máxima: 40,6W/mt
Aplicação | Aplicación:
Encastrar | Empotrar

Difusor recolhido
Difusor empotrado

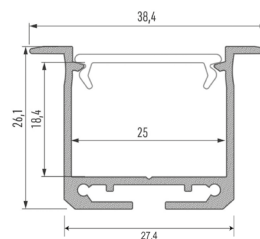

Ref.	Cor Color
PFA2121	Anodizado Anodizado
PFA2122	Lacado Branco Laca Blanco
PFA2121.3	Anodizado 3mt Anodizado 3mt
PFA2122.3	Lacado Branco 3mt Laca Blanco 3mt



Ref.	Cor Color
TP2121	Topo PL Cinza Tapa PL Gris
TP2122	Topo PL Branco Tapa PL Blanco
TP2121AL	Topo AL Cinza Tapa AL Gris

Este é um perfil de encastrar idealizado para uso no teto ou parede. Permite a utilização de duas fitas de Led em paralelo.

Se trata de un perfil de empotrar diseñado para su uso en techo o pared. Permite el uso de dos tiras de LED en paralelo.

ACESSÓRIOS DISPONÍVEIS | ACCESORIOS DISPONIBLES

Uniões de ligação | Uniones



DIFUSORES

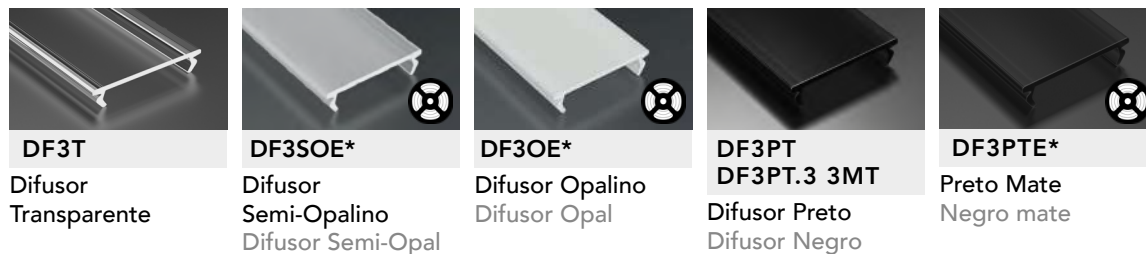

*Disponível em: *Disponible en:

VARA 2m	VARA 3m	10m	20m	30m	40m	50m
DF3PTE	DF3SOE.3	DF3SOE.10	DF3SOE.20	DF3SOE.30	DF3SOE.40	DF3SOE.50
	DF3OE.3	DF3OE.10	DF3OE.20	DF3OE.30	DF3OE.40	DF3OE.50
		DF3PTE.10				DF3PTE.50

PERFIS ENCASTRE

PERFIL inTALIA



Potência máxima
Potencia máxima: 60,2W/mt
Aplicação | Aplicación:
Encastrar | Empotrar

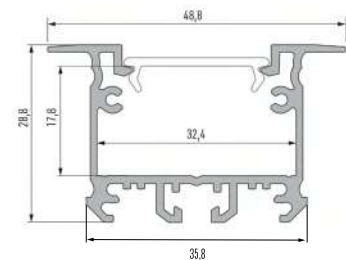

Ref.	Cor Color
PFA2401	Anodizado Anodizado
PFA2402	Lacado Branco Laca Blanco
PFA2401.3	Anodizado 3mt Anodizado 3mt
PFA2402.3	Lacado Branco 3mt Laca Blanco 3mt

Ref.	Cor Color
TP2402AL	Topo AL Branco Tapa AL Blanco

ACESSÓRIOS DISPONÍVEIS | ACCESORIOS DISPONIBLES

Uniões de ligação | Uniones

228521U	228521UA	228521UT	228521UA120
Molas para perfil Clip metálico	Passa cabos Pasa cables		
228522	228657		

DIFUSORES

DF3T Difusor Transparente	DF3SOE* Difusor Semi-Opalino Difusor Semi-Opal	DF3OE* Difusor Opalino Difusor Opal	DF3PT DF3PT.3 3MT Difusor Preto Difusor Negro	DF3PTE* Preto Mate Negro mate



*Disponível em:
*Disponible en:

DF3PTE	DF3SOE.3 DF3OE.3	DF3SOE.10 DF3OE.10 DF3PTE.10	DF3SOE.20 DF3OE.20	DF3SOE.30 DF3OE.30	DF3SOE.40 DF3OE.40	DF3SOE.50 DF3OE.50 DF3PTE.50

PERFIL INSO



Perfil Indiana



Potência máxima
 Potencia máxima: 84W/mt
 Aplicação | Aplicación:
 Encastrar | Empotrar

Ref.	Cor Color
PFA2161	Anodizado Anodizado
PFA2162	Lacado Branco Laca Blanco
PFA2168	Preto Mate Negro Mate
PFA2161.3	Anodizado 3mt Anodizado 3mt
PFA2162.3	Lacado Branco 3mt Laca Blanco 3mt
PFA2168.3	Preto Mate 3mt Negro Mate 3mt

Ref.	Cor Color
TP2161	Topo PL Cinza Tapa PL Gris
TP2162	Topo PL Branco Tapa PL Blanco
TP2161AL	Topo AL Cinza Tapa AL Gris
TP2162AL	Topo AL Branco Tapa AL Blanco

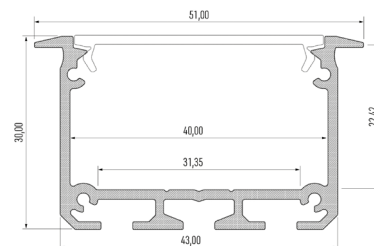

O perfil Indiana é um perfil de encastrar e destaca-se pela possibilidade de criar linhas de luz.
 El perfil Indiana es un perfil de empotrar y destaca por la posibilidad de crear líneas ligeras.

ACESSÓRIOS DISPONÍVEIS | ACCESORIOS DISPONIBLES

Uniões de ligação | Uniones



228521U



228521UA



228521UT



228521UA120



Molas para perfil
 Clip metálico

228522

DIFUSORES

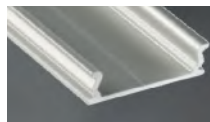

DF4A

Difusor Alumínio
 Difusor Aluminio

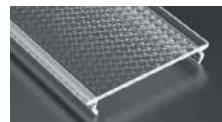

DF4P

Difusor Prismático
 (Baixo UGR)

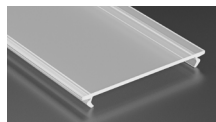

DF4SO | DF4SO.3

Difusor
 Semi-Opalino
 Difusor Semi-Opal

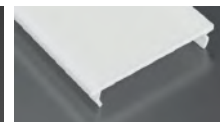

DF4O | DF4O.3

Difusor Opalino
 Difusor Opal



DF4LM

Difusor de Lamelas
 Difusor de Láminas

PERFIS ENCASTRE

PERFIL inLARGO



Potência máxima
 Potencia máxima: 130,2W/mt
 Aplicação | Aplicación:
 Encastrar | Empotrar

Ref.	Cor Color
PFA2231	<input checked="" type="checkbox"/> Anodizado <input type="checkbox"/> Anodizado
PFA2232	<input type="checkbox"/> Lacado Branco <input type="checkbox"/> Laca Blanco
PFA2232.3	<input type="checkbox"/> Lacado Branco 3mt <input type="checkbox"/> Laca Blanco 3mt

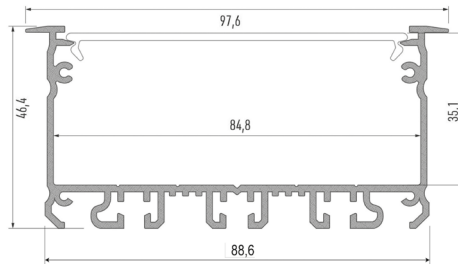

	TP2231	<input checked="" type="checkbox"/> Topo AL Cinza <input type="checkbox"/> Tapa AL Gris
	TP2232	<input type="checkbox"/> Topo AL Branco <input type="checkbox"/> Tapa AL Blanco

Perfil de encastrar que pode suportar até 6 fitas de led em paralelo.

Perfil de empotrar que puede soportar hasta 6 tiras LED en paralelo.

ACESSÓRIOS DISPONÍVEIS | ACCESORIOS DISPONIBLES

Unões de ligação | Uniones



DIFUSORES

DF11T	DF11SO	DF11O
Difusor Transparente	Difusor Semi-Opalino Difusor Semi-Opal	Difusor Opalino Difusor Opal





PERFIS ENCASTRE CERÂMICA

Perfiles Empotrar Ceramica

PERFIS ENCASTRE CERÂMICA

PERFIL ANSIÃES



Aplicação | Aplicación:
Encastre em Cerâmica
Empotrar en Ceramica

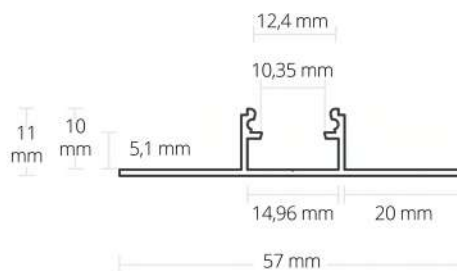

Ref.	Cor Color
PFG02032	Anodizado Anodizado

	TPG023001	Topo PL Cinza Tapa PL Gris
--	------------------	-------------------------------

	DFG00004	Difusor Semi-Opalino Difusor Semi-Opal
	DFG00154	Difusor Opalino Difusor Opal
	DFG00070	Difusor Preto Difusor Negro

	DFG00065	Difusor Protetor 5mt Difusor Protector 5mt
--	-----------------	---



Difusor técnico de obra reutilizável para proteção do perfil durante a montagem.

Difusor de obra técnica reutilizable para la protección de perfiles durante el montaje.

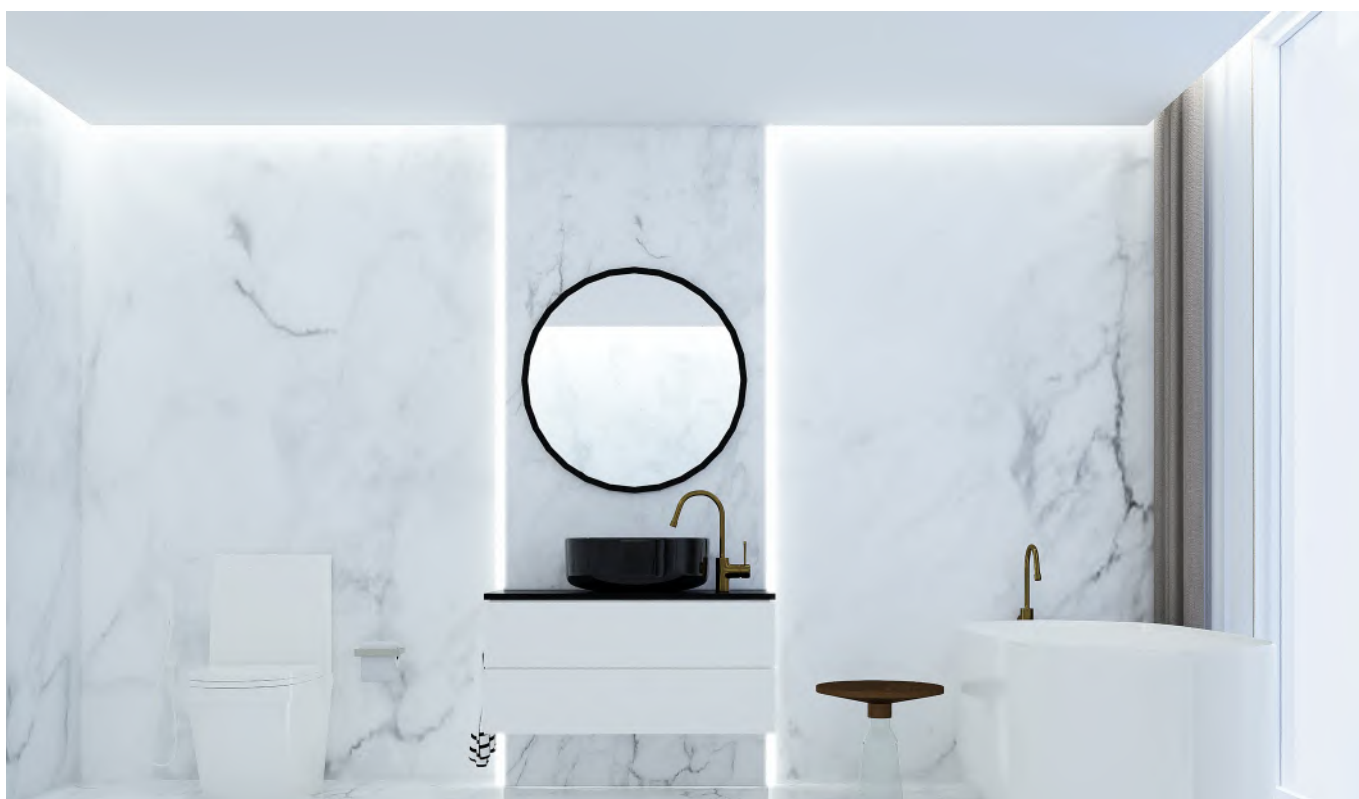

PERFIS ENCASTRE CERÂMICA

PERFIL CRATO



Aplicação | Aplicación:
Encastre em Cerâmica
Empotrar en Cerámica

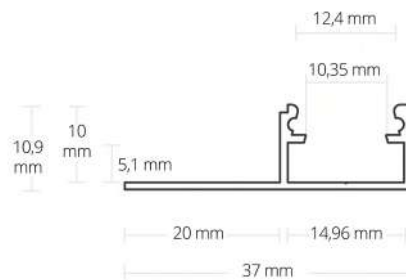

Ref.	Cor Color
PFG02034	Anodizado Anodizado

	TPG023003	Topo PL Cinza Tapa PL Gris
--	-----------	-------------------------------

	DFG00004	Difusor Semi-Opalino Difusor Semi-Opal
	DFG00154	Difusor Opalino Difusor Opal
	DFG00070	Difusor Preto Difusor Negro
	DFG00065	Difusor Protetor 5mt Difusor Protector 5mt

Difusor técnico de obra reutilizável para proteção do perfil durante a montagem.
Difusor de obra técnica reutilizable para la protección de perfiles durante el montaje.



PERFIL ALCÁCER DO SAL



Aplicação | Aplicación:
Encastre em Cerâmica
Empotrar en Ceramica

Perfil de alumínio, embutido em cerâmica de 10 mm.

Perfil de aluminio con reborde, empotrado en cerámica de 10 mm.

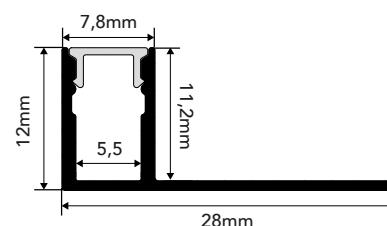

Modelo	Ref.	Cor Color
ALCÁCER DO SAL	PFA211271	Anodizado c/ Difusor Semi-Opalino Anodizado c/ Difusor Semi-Opalino

APLICAÇÃO | APLICACIÓN



PERFIS ENCASTRE CERÂMICA

PERFIL MONSARAZ



Aplicação | Aplicación:
Encastre em Cerâmica
Empotrar en Cerámica

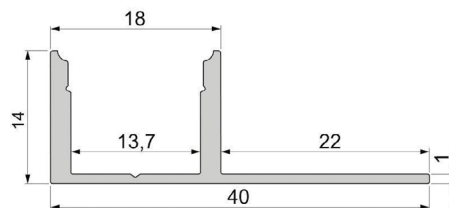

Ref.	Cor Color
PFD5361	Anodizado Anodizado

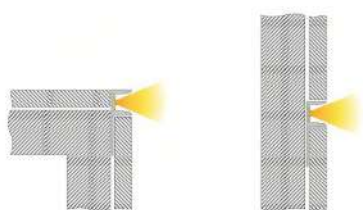

	DFD3023	Difusor Semi-Opalino Difusor Semi-Opal
	DFD3025	Difusor Opalino Difusor Opal
	DFD4023	Difusor Semi-Opalino Difusor Semi-Opal
	DFD4025	Difusor Opalino Difusor Opal

PERFIL MELGAÇO



Aplicação | Aplicación:
Encastre em Cerâmica
Empotrar en Cerámica



Aplicação | Aplicación:
Encastre em Cerâmica
Empotrar en Cerámica

Ref.	Cor Color
PFG23174	Anodizado Anodizado
PFG23322	Anodizado Branco Anodizado Blanco

Ref.	Cor Color
PFG23176	Anodizado Anodizado
PFG23320	Anodizado Branco Anodizado Blanco

	DFG00046	Difusor Semi-Opalino Difusor Semi-Opal
	DFG00074	Difusor Preto Difusor Negro

	DFG00046	Difusor Semi-Opalino Difusor Semi-Opal
	DFG00074	Difusor Preto Difusor Negro

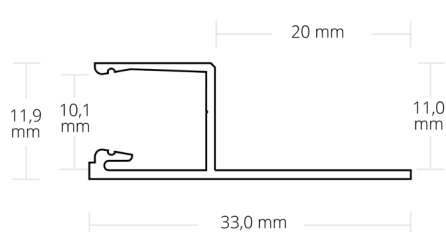
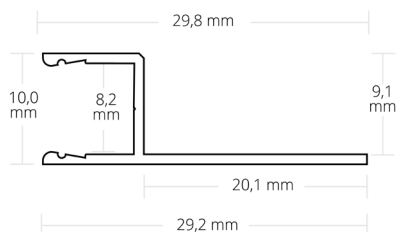

PERFIS ENCASTRE CERÂMICA

PERFIL MOURÃO

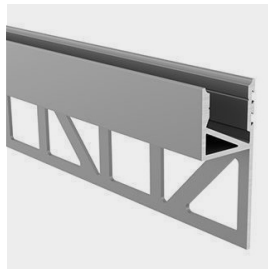

Aplicação | Aplicación:
Encastre em Cerâmica
Empotrar en Cerámica

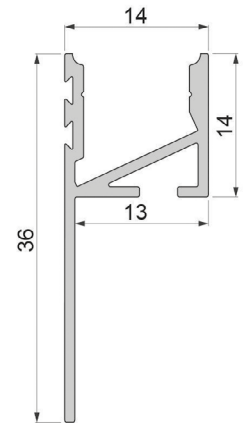

Ref.	Cor Color
PFD5390	<input checked="" type="checkbox"/> Anodizado <input type="checkbox"/> Anodizado
PFD5394	<input type="checkbox"/> Branco Mate <input type="checkbox"/> Blanco Mate



DFD3003	Difusor Semi-Opalino Difusor Semi-Opal
DFD3005	Difusor Opalino Difusor Opal

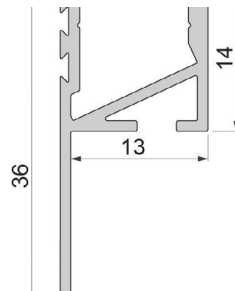

PERFIS ENCASTRE CERÂMICA

PERFIL ALJEZUR



Aplicação | Aplicación:
Canto | Esquina

Ref.	Cor Color
PFD5352	Anodizado Anodizado

	TPD0511	■ Topo Cinza Tapa Gris
	TPD8231	■ Topo Cinza Tapa Gris

	DFD5505	Difusor Opalino Difusor Opal
	DFD3003	Difusor Semi-Opalino Difusor Semi-Opal
	DFD3005	Difusor Opalino Difusor Opal

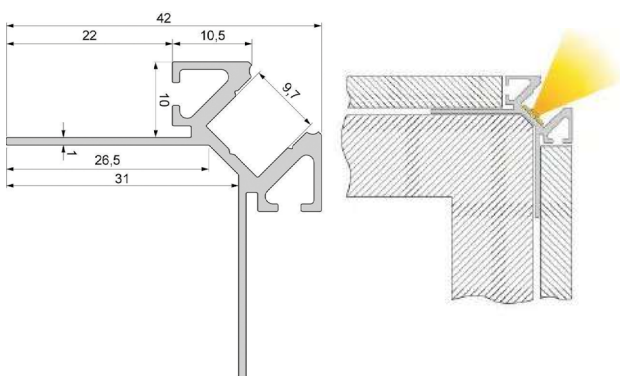

PERFIL MIRANDELA



Aplicação | Aplicación:
Canto | Esquina

Ref.	Cor Color
PFG02036	Anodizado Anodizado

	TPG023005	■ Topo Cinza Tapa Gris
--	------------------	---------------------------

	DFG00004	Difusor Semi-Opalino Difusor Semi-Opal
	DFG00154	Difusor Opalino Difusor Opal
	DFG00070	Difusor Preto Difusor Negro

	DFG00065	Difusor Protetor 5mt Difusor Protector 5mt
--	-----------------	---

Difusor técnico de obra reutilizável para proteção do perfil durante a montagem.

Difusor de obra técnica reutilizable para la protección de perfiles durante el montaje.

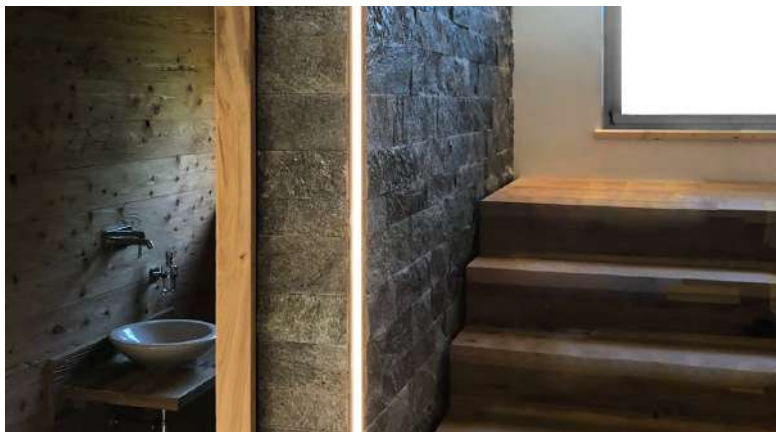
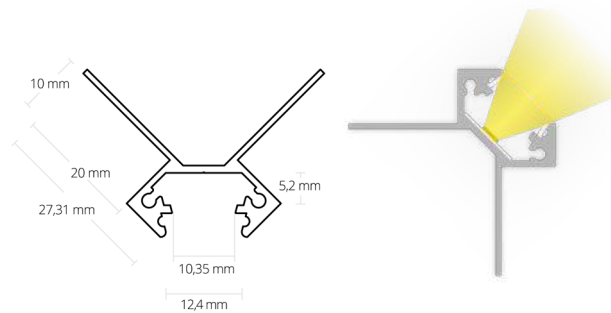

PERFIS ENCASTRE CERÂMICA

PERFIL MARVÃO



Aplicação | Aplicación:
Canto | Esquina

Ref.	Cor Color
PFD5371	Anodizado Anodizado

	DFD3023	Difusor Semi-Opalino Difusor Semi-Opal
	DFD3025	Difusor Opalino Difusor Opal

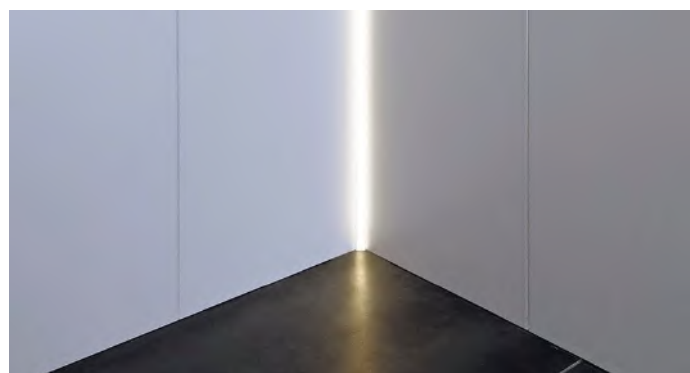
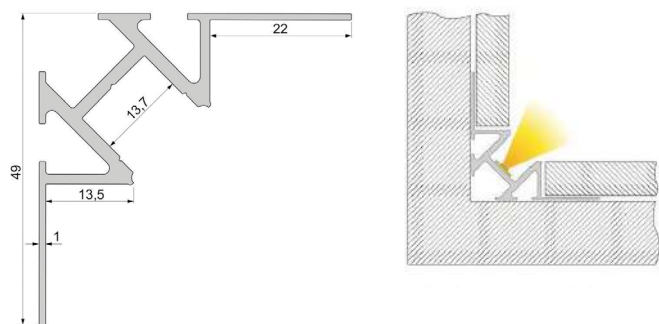



PERFIL POMBAL



Aplicação | Aplicación:
Canto | Esquina

Ref.	Cor Color
PFG02230	Anodizado Anodizado

	TPG023007	Topo Cinza Tapa Gris
---	------------------	-------------------------

	DFG00004	Difusor Semi-Opalino Difusor Semi-Opal
	DFG00154	Difusor Opalino Difusor Opal
	DFG00070	Difusor Preto Difusor Negro

	DFG00065	Difusor Protetor 5mt Difusor Protector 5mt
---	-----------------	---

Difusor técnico de obra reutilizável para proteção do perfil durante a montagem.
Difusor de obra técnica reutilizable para la protección de perfiles durante el montaje.

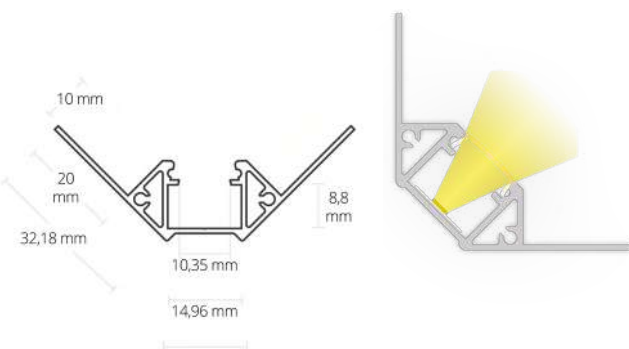



Com os perfis de alumínio de encastre obtemos uma aplicação da luz à face da superfície aplicada com a vantagem de ocultar quase todo o alumínio que serve de apoio à aplicação da fita Led. Estes perfis dispõem de uma pequena aba para um melhor acabamento da superfície aplicada.

Con los perfiles de aluminio empotrados conseguimos una aplicación de luz a la cara de la superficie aplicada con la ventaja de ocultar casi todo el aluminio que soporta la aplicación de la tira LED. Estos perfiles tienen una pequeña solapa para un mejor acabado de la superficie aplicada.

ENCASTRE | EMPOTRAR

PERFIS DE BARRAMENTO

Perfiles de Barramiento

PERFIS DE BARRAMENTO

PERFIL VIDIGUEIRA



Aplicação | Aplicación:
Encastre | Empotrado

Perfil de alumínio superfino de encaixe para gesso.

Perfil de aluminio superfino de encaje para yeso.

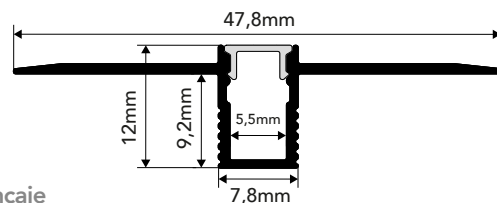

Modelo	Ref.	Cor Color
VIDIGUEIRA	PFA81221	Anodizado c/ Difusor Semi-Opalino Anodizado c/ Difusor Semi-Opalino

Ref.	Acessórios
TP81221	Topo Plástico Cinza Topo Plástico Gris

APLICAÇÃO | APLICACIÓN

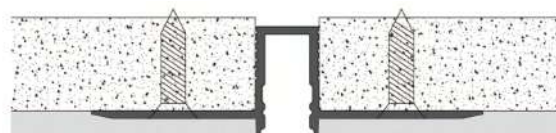

PERFIL LOULÉ

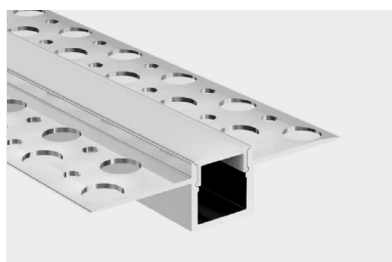

Aplicação | Aplicación:
Encastre | Empotrado

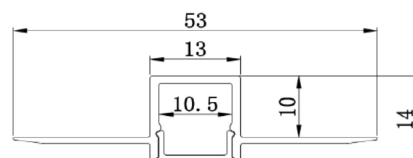

Modelo	Ref.	Cor Color
LOULÉ	PFA8821	Anodizado c/ Difusor Semi-Opalino Anodizado c/ Difusor Semi-Opalino

Ref.	Acessórios
TP8821	Topo Plástico Cinza Topo Plástico Gris

Modelo	Ref.	Cor Color
	PFA81431	Perfil Anodizado sem Difusor Perfil Anodizado sin Difusor
TORRE DE LOULÉ	DFSL8*	Difusor Opalino Silicone Difusor Opalino Silicona
	DF8SO*	Difusor Semi-Opalino Difusor Semi-Opalino

*Disponível em | Disponible en:



PERFIS DE BARRAMENTO

PERFIL ALENQUER

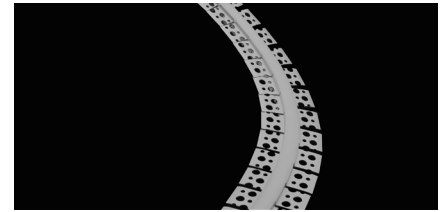
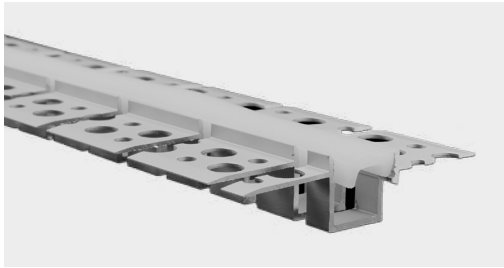

Aplicação | Aplicación:
Encastre | Empotrado

Perfil flexível, permite fazer curvatura up e side.

Perfil flexible, permite realizar curvaturas hacia arriba y hacia los lados.

Modelo	Ref.	Cor Color
ALENQUER	PFA18881	Anodizado c/ Difusor Semi-Opalino Anodizado c/ Difusor Semi-Opalino

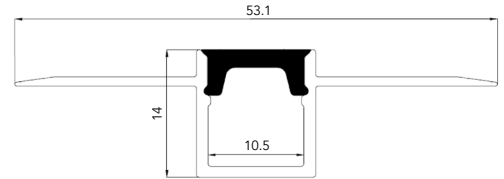

TP8821	Topo Plástico Cinza Topo Plástico Gris
DFSL8*	Difusor Opalino Silicone Difusor Opalino Silicon

*Disponível em | Disponible en:



PERFIL GAUDI



Potência máxima 30,1W/mt
Aplicação: Gesso
Aplicación: Yeso

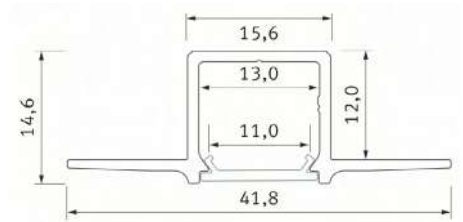

Ref.	Cor Color
PFA8781	Anodizado Anodizado
PFA8782	Lacado Branco Laca Blanco
PFA8787	Não Anodizado No Anodizado
PFA8788	Lacado Preto Laca Negro
PFA8781.3	Anodizado 3mt Anodizado 3mt
PFA8782.3	Lacado Branco 3mt Laca Blanco 3mt
PFA8787.3	Não Anodizado 3mt No Anodizado 3mt
PFA8788.3	Lacado Preto 3mt Laca Negro 3mt

TPF8781	Topo PL Cinza Tapa PL Gris
TPF8782	Topo PL Branco Tapa PL Blanco
TPF8788	Topo PL Preto Tapa PL Negro

DF1LT DF1LT30	DF1T	DF1SOE*	DF1F	DF1OE*	DF1PT DF1PT.3
Difusor Lente 15° Difusor Lente 30°	Difusor Transparente	Difusor Semi-Opalino Difusor Semi-Opal	Difusor Fosco Difusor Mate	Difusor Opalino Difusor Opal	Difusor Preto Difusor Negro



*Disponível em:
*Disponible en:



DF1OB
Difusor de Obra
Difusor de construcción

PERFIS DE BARRAMENTO

PERFIL ALVOR



Aplicação | Aplicación:
Encastre | Empotrado

Solução de perfil para instalação em gesso
Solución de perfil para instalación en yeso

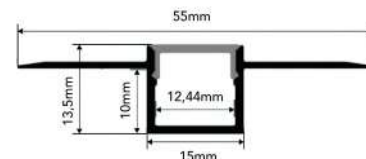

Modelo	Ref.	Cor Color
ALVOR	PFA81021	Anodizado c/ Difusor Semi-Opalino Anodizado c/ Difusor Semi-Opalino

Modelo	Ref.	Cor Color
	PFA81291	Perfil Anodizado sem Difusor Perfil Anodizado sin Difusor
TORRE DE ALVOR	DF17SO*	Difusor Semi-Opalino Difusor Semi-Opalino
	DFSL17*	Difusor Silicone Difusor Silicona

Ref.	Acessórios
TP81021	Topo Plástico Cinza Topo Plástico Gris
TPF81021	Topo Plástico c/ Furo Cinza Topo Plástico c/ Orificio Gris

*Disponível em | Disponible en:

VARA 2m	10m	50m
DF17SO DFSL17	DF17SO.10 DFSL17.10	DF17SO.50 DFSL17.50

PERFIL CAMPO MAIOR

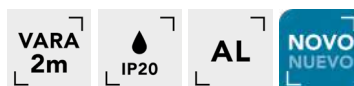

Aplicação | Aplicación:
Encastre Flexível | Empotrado Flexible

Projetado para fitas led flexíveis com largura máxima de 12 mm. | Diseñado para tiras led flexibles con un ancho máximo de 12 mm.

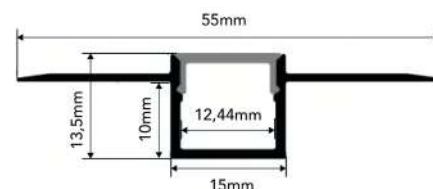

Modelo	Ref.	Cor Color
CAMPO MAIOR	PFA181251	Anodizado c/ Difusor Semi-Opalino Anodizado c/ Difusor Semi-Opalino

Modelo	Ref.	Cor Color
	PFA181441	Perfil Anodizado sem Difusor Perfil Anodizado sin Difusor
TORRE DE CAMPO MAIOR	DF17SO*	Difusor Semi-Opalino Difusor Semi-Opalino
	DFSL17*	Difusor Silicone Difusor Silicona

Ref.	Acessórios
TP81021	Topo Plástico Cinza Topo Plástico Gris
TPF81021	Topo Plástico c/ Furo Cinza Topo Plástico c/ Orificio Gris

*Disponível em | Disponible en:

VARA 2m	10m	50m
DF17SO DFSL17	DF17SO.10 DFSL17.10	DF17SO.50 DFSL17.50

PERFIS DE BARRAMENTO

PERFIL MONO



Potência máxima
Potencia máxima: 34W/mt
Aplicação | Aplicación:
Gesso | Yeso

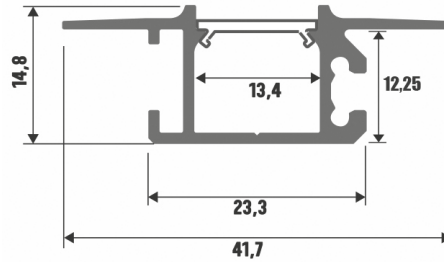

Ref.	Cor Color
PFA8441	Anodizado Anodizado
PFA8442	Lacado Branco Laca Blanco

Ref.	Cor Color
TP8441D	Topo AL Cinza Dir. Tapa AL Gris Derecha
TP8441E	Topo AL Cinza Esq. Tapa AL Gris Izquierda

Perfil com a mesma medida de altura da placa de gesso cartonado. Para aplicação de tira de fita LED.

Perfil con la misma medida de altura que la placa de yeso. Para la aplicación de tira de LED.

TP8442D	Topo AL Branco Dir. Tapa AL Blanco Derecha
TP8442E	Topo AL Branco Esq. Tapa AL Blanco Izquierda

ACESSÓRIOS DISPONÍVEIS
| **ACCESORIOS DISPONIBLES**

Uniões de ligação | Uniones



228521U



228521UA



228521UT

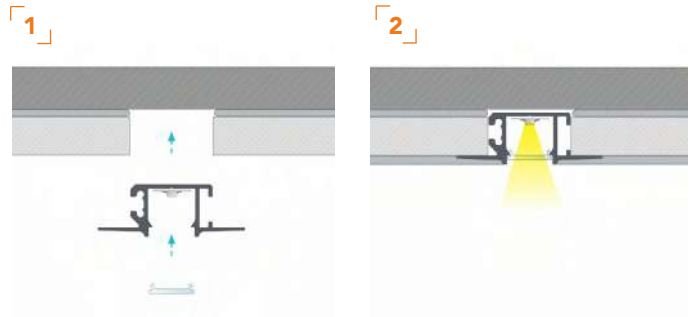

DIFUSORES



DF1LT | DF1LT30
Difusor Lente 15°
Difusor Lente 30°

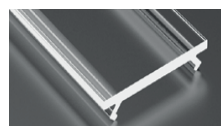

DF1T
Difusor
Transparente



DF1SOE*
Difusor
Semi-Opalino
Difusor Semi-Opal

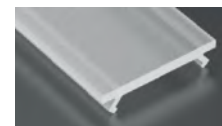

DF1OB
Difusor de Obra
Difusor de
construcción

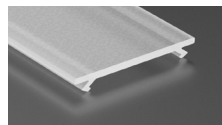

DF1F
Difusor Fosco
Difusor Mate



DF1OE*
Difusor Opalino
Difusor Opal

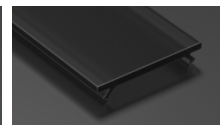

DF1PT | DF1PT.3
Difusor Preto
Difusor Negro



*Disponível em:
*Disponible en:



DF1SOE.3 DF1SOE.10 DF1SOE.20 DF1SOE.30 DF1SOE.40 DF1SOE.50
DF1OE.3 DF1OE.10 DF1OE.20 DF1OE.30 DF1OE.40 DF1OE.50

PERFIS DE BARRAMENTO

PERFIL HIRO



VARA 3m VARA 2m
AL CORTE 27,2mm

Potência máxima 43,7W/mt
Aplicação: Encastrar / Gesso
Aplicación: Empotrar / Yeso

PERFIL LAGOINHA

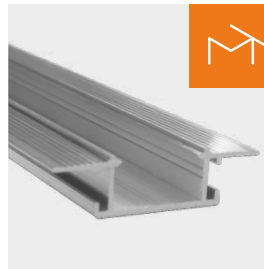

VARA 3m VARA 2m AL CORTE 34,8mm

Potência máxima 47,6W/mt
Aplicação: Encastrar / Gesso
Aplicación: Empotrar / Yeso

Ref.	Cor Color
PFA8771	Anodizado Anodizado
PFA8772	Lacado Branco Laca Blanco
PFA8777	Não Anodizado No Anodizado
PFA8778	Lacado Preto Laca Negro
PFA8771.3	Anodizado 3mt Anodizado 3mt
PFA8772.3	Lacado Branco 3mt Laca Blanco 3mt
PFA8777.3	Não Anodizado 3mt No Anodizado 3mt
PFA8778.3	Lacado Preto 3m Laca Negro 3m

Ref.	Cor Color
PFA8451	Não Anodizado No Anodizado
PFA8451.3	Não Anodizado 3mt No Anodizado 3mt
TP8451	Topo AL Cinza Tapa AL Gris

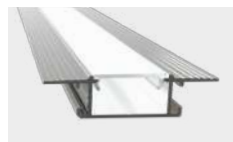

Difusor à face do perfil
Difusor facial del perfil

* Possibilidade de fornecimento em 4 e 6 metros.
* Posibilidad de suministro en 4 y 6 metros.



TPF8771	Topo PL Cinza Tapa PL Gris
TPF8772	Topo PL Branco Tapa PL Blanco
TPF8778	Topo PL Preto Tapa PL Negro

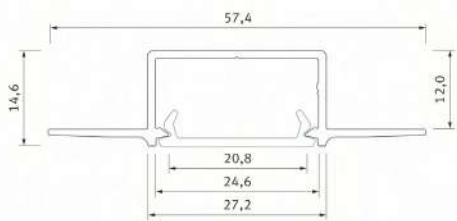
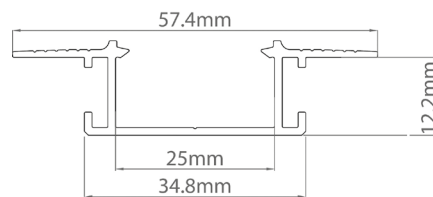

**ACESSÓRIOS DISPONÍVEIS
ACCESORIOS DISPONIBLES**

Unões de ligação | Uniones



DIFUSORES

DF3T Difusor Transparente	DF3SOE* Difusor Semi-Opalino Difusor Semi-Opal	DF3OE* Difusor Opalino Difusor Opal	DF3PT DF3PT.3 3MT Difusor Preto Difusor Negro	DF3PTE* Preto Mate Negro mate	DF3OB Difusor de Obra Difusor de construcción



*Disponível em:
*Disponible en:

VARA 2m	VARA 3m	10m	20m	30m	40m	50m
DF3PTE	DF3SOE.3 DF3OE.3	DF3SOE.10 DF3OE.10	DF3SOE.20 DF3OE.20	DF3SOE.30 DF3OE.30	DF3SOE.40 DF3OE.40	DF3SOE.50 DF3OE.50 DF3PTE.50

PERFIS DE BARRAMENTO

PERFIL ALCANEDE

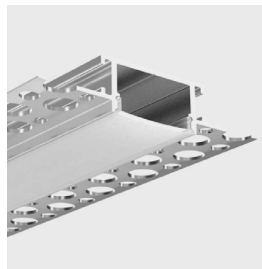

Aplicação | Aplicación:
Encastre | Empotrado

Solução de perfil para instalação em gesso
Solución de perfil para instalación en yeso

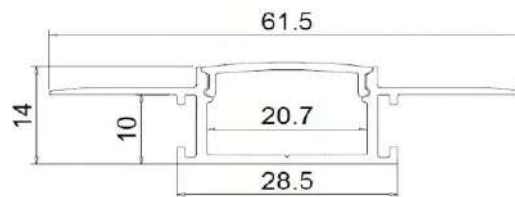

Modelo	Ref.	Cor Color
ALCANEDE	PFA8811	Anodizado c/ Difusor Semi-Opalino Anodizado c/ Difusor Semi-Opalino
	PFA8818	Anodizado c/ Difusor Preto Anodizado c/ Difusor Negro

Modelo	Ref.	Cor Color
TORRE DE ALCANEDE	PFA8941	Perfil Anodizado sem Difusor Perfil Anodizado sin Difusor
	DF9SO*	Difusor Semi-Opalino Difusor Semi-Opalino
	DF9PT*	Difusor Preto Difusor Negro
	DFSL9*	Difusor Opalino Silicone Difusor Opalino Silicona

* Perfil com possibilidade de fazer ângulos.
* Perfil con posibilidad de hacer ángulos.

	Ref.	Acessórios
	TP8811	Topo Plástico Cinza Topo Plástico Gris
	PFA8811.H90	Ângulo 90° na Horizontal Ángulo de 90° en Horizontal
	PFA8811.VI90	Ângulo 90° na Vertical Interior Ángulo de 90° en la Vertical Interior
	PFA8811.VE90	Ângulo 90° na Vertical Exterior Ángulo de 90° en Vertical Exterior



*Disponível em | Disponible en:



DF9SO
DF9PT
DFSL9



DF9SO.10
DF9PT.10
DFSL9.10



DF9SO.50
DF9PT.50
DFSL9.50

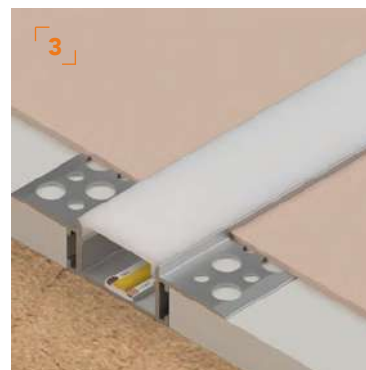

PERFIS DE BARRAMENTO

PERFIL PENAFIEL

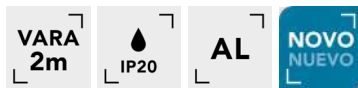

Aplicação | Aplicación:
Encastre | Empotrado

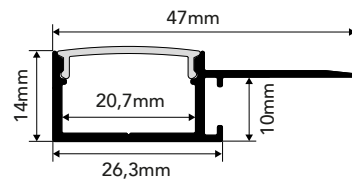

Modelo	Ref.	Cor Color
PENAFIEL	PFA81201	Anodizado c/ Difusor Semi-Opalino Anodizado c/ Difusor Semi-Opalino
	PFA81371	Perfil Anodizado s/ Difusor Perfil Anodizado s/ Difusor
	PFA81372	Perfil Branco s/ Difusor Perfil Blanco s/ Difusor
TORRE DE PENAFIEL	DF9SO*	Difusor Semi-Opalino Difusor Semi-Opalino
	DF9PT*	Difusor Preto Difusor Negro
	DFSL9*	Difusor Opalino Silicone Difusor Opalino Silicona

Ref.	Acessório
TP8811	Topo Plástico Cinza Topo Plástico Gris
PFA81201.H90	Ângulo 90° Horizontal Ângulo de 90° Horizontal
PFA81201.VI90	Ângulo 90° Vertical Interior Ângulo de 90° Vertical Interior
PFA81201.VE90	Ângulo 90° Vertical Exterior Ângulo de 90° Vertical Exterior



*Disponível em | Disponible en:

VARA 2m	10m	50m
DF9SO	DF9SO.10	DF9SO.50
DF9PT	DF9PT.10	DF9PT.50
DFSL9	DFSL9.10	DFSL9.50

PERFIL PORTALEGRE

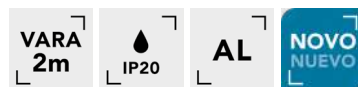
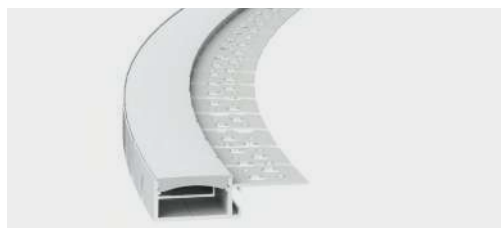

Aplicação | Aplicación:
Encastre | Empotrado

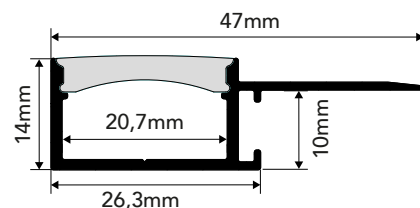

Modelo	Ref.	Descrição
PORTALEGRE	PFA181181	Anodizado c/ Difusor Semi-Opalino Anodizado c/ Difusor Semi-Opalino
	PFA181182	Perfil Branco c/ Difusor Perfil Blanco s/ Difusor
	PFA181361	Perfil Anodizado s/ Difusor Perfil Anodizado s/ Difusor
TORRE DE PORTALEGRE	PFA181362	Perfil Branco s/ Difusor Perfil Blanco s/ Difusor
	DFSL9*	Difusor Opalino Silicone Difusor Opalino Silicona

Ref.	Acessório
TP8811	Topo Plástico Cinza Topo Plástico Gris



*Disponível em | Disponible en:

VARA 2m	10m	50m
DFSL9	DFSL9.10	DFSL9.50

APLICAÇÃO | APLICACIÓN

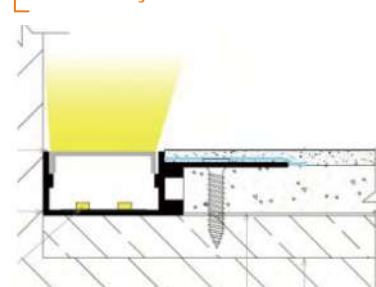

PERFIS DE BARRAMENTO

PERFIL MONTALEGRE



VARA 2m	AL	CORTE 29,1mm
------------	----	-----------------

Aplicação | Aplicación:
Gesso | Yeso

Perfil fornecido com difusor semi-opalino.
Perfil suministrado con difusor semiopalino.

_Permite a criação de luminárias curvas
_Permite la creación de luminarias curvas



PERFIL
FLEXÍVEL

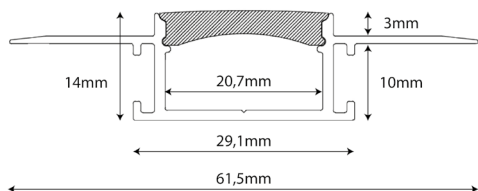
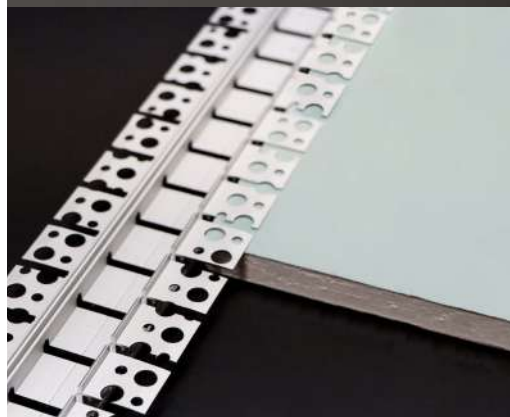

Ref.	Cor Color
PFA18797	Anodizado c/ Difusor Semi-Opalino Anodizado c/ Difusor Semi-Opalino

Ref.	Acessórios
TP18797	Topo Plástico Cinza Topo Plástico Gris

Modelo	Ref.	Cor Color
TORRE DE MONTALEGRE	PFA81281	Perfil Anodizado sem Difusor Perfil Anodizado sin Difusor
	DFSL9*	Difusor Opalino Silicone Difusor Opalino Silicona

*Disponível em | Disponible en:

VARA 2m	10m	50m
DFSL9	DFSL9.10	DFSL9.50

PERFIS DE BARRAMENTO

PERFIL ZATI



Potência máxima
Potencia máxima: 47,6W/mt
Aplicação | Aplicación:
Encastrar / Gesso
Empotrar / Yeso

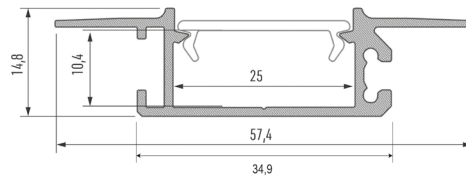

Difusor recolhido
Difusor empotrado

Ref.	Cor Color
PFA8201	<input checked="" type="checkbox"/> Anodizado <input type="checkbox"/> Anodizado
PFA8202	<input type="checkbox"/> Lacado Branco <input type="checkbox"/> Laca Blanco



Ref.	Cor Color
TPD201	<input checked="" type="checkbox"/> Topo AL Cinza Dir. <input type="checkbox"/> Tapa AL Gris Dcho.
TPE201	<input checked="" type="checkbox"/> Topo AL Cinza Esq. <input type="checkbox"/> Tapa AL Gris Izq.
TPD202	<input type="checkbox"/> Topo AL Branco Dir. <input type="checkbox"/> Tapa AL Blanco Dcho.
TPE202	<input type="checkbox"/> Topo AL Branco Esq. <input type="checkbox"/> Tapa AL Blanco Izq.

Perfil de encastre com uma altura igual à de uma placa de gesso. Após a aplicação do perfil, como as abas de remate são barradas, deixam de estar visíveis. Ideal para ser aplicado entre placas de gesso.

Perfil empotrado de altura igual a la de una placa de yeso. Después de la aplicación del perfil, como las solapas de acabado están enrejadas, ya no son visibles. Ideal para aplicar entre placas de yeso.

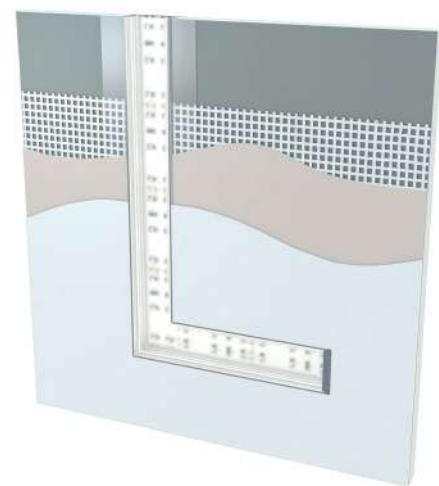

ACESSÓRIOS DISPONÍVEIS | ACCESORIOS DISPONIBLES

Unões de ligação | Uniones



DIFUSORES

DF3T Difusor Transparente	DF3SOE* Difusor Semi-Opalino Difusor Semi-Opal	DF3OE* Difusor Opalino Difusor Opal	DF3PT DF3PT.3 3MT Difusor Preto Difusor Negro	DF3PTE* Preto Mate Negro mate	DF3OB Difusor de Obra Difusor de construcción



*Disponível em:
*Disponible en:

DF3PTE	DF3SOE.3 DF3OE.3	DF3SOE.10 DF3OE.10 DF3PTE.10	DF3SOE.20 DF3OE.20	DF3SOE.30 DF3OE.30	DF3SOE.40 DF3OE.40	DF3SOE.50 DF3OE.50 DF3PTE.50

PERFIS DE BARRAMENTO

PERFIL LAMEGO



VARA 2m AL

Aplicação | Aplicación:
Encastre Barramento de canto
Empotrar Barramiento de esquina

Ref.	Cor Color
PFG02045	Anodizado Anodizado

	TPG023017	Topo Cinza Tapa Gris
---	-----------	-------------------------

	DFG00004	Difusor Semi-Opalino Difusor Semi-Opal
---	----------	---

	DFG00154	Difusor Opalino Difusor Opal
---	----------	---------------------------------

	DFG00070	Difusor Preto Difusor Negro
--	----------	--------------------------------

	DFG00065	Difusor Protetor 5mt Difusor Protector 5mt
---	----------	---

Difusor técnico de obra reutilizável para proteção do perfil durante a montagem.

Difusor de obra técnica reutilizable para la protección de perfiles durante el montaje.

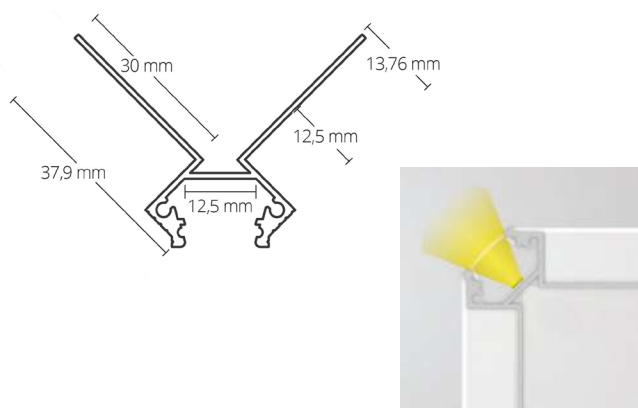

PERFIL PALMELA



VARA 2m AL

Aplicação | Aplicación:
Encastre Barramento
Empotrar Barramiento

Ref.	Cor Color
PFG02042	Anodizado Anodizado

	TPG23011	Topo Cinza Tapa Gris
---	----------	-------------------------

	DFG00004	Difusor Semi-Opalino Difusor Semi-Opal
---	----------	---

	DFG00154	Difusor Opalino Difusor Opal
---	----------	---------------------------------

	DFG00070	Difusor Preto Difusor Negro
--	----------	--------------------------------

	DFG00065	Difusor Protetor 5mt Difusor Protector 5mt
---	----------	---

Difusor técnico de obra reutilizável para proteção do perfil durante a montagem.

Difusor de obra técnica reutilizable para la protección de perfiles durante el montaje.

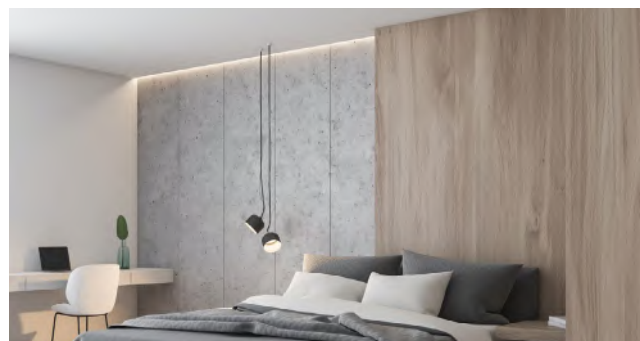
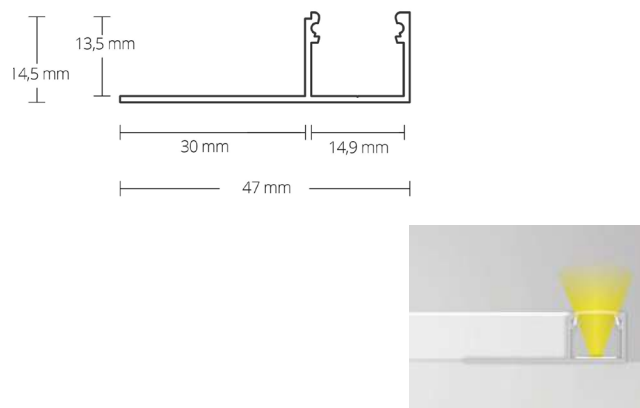

PERFIS DE BARRAMENTO

PERFIL BRUNO



VARA 2m
IP20
AL
NOVO NUEVO

Aplicação | Aplicación:
Encastre | Empotrado

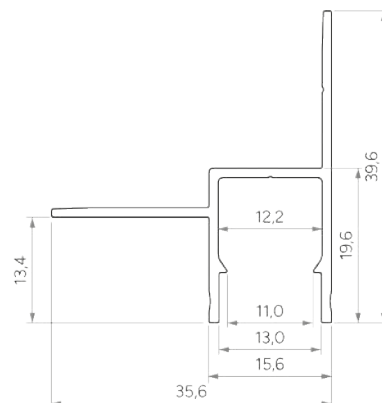

Ref.	Cor Color
PFA19977	Não Anodizado No Anodizado
PFA19972	Lacado Branco Laca Blanco

Ref.	Cor Color
TPF19971	Topo PL Cinza Tapa PL Gris
TPF19972	Topo PL Branco Tapa PL Blanco

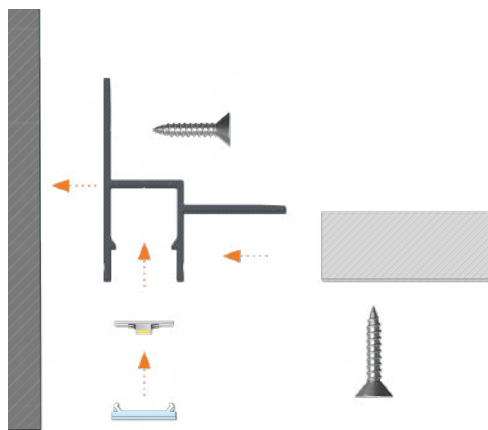
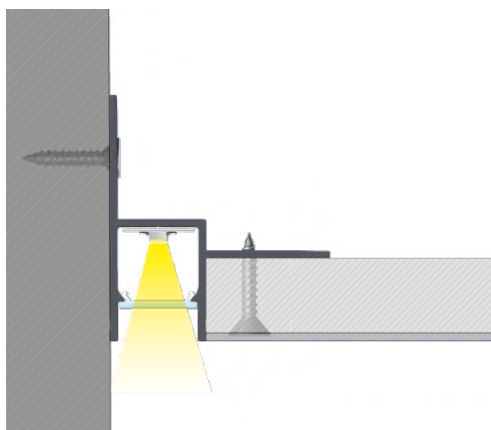

DIFUSORES

DF1LT DF1LT30 Difusor Lente 15° Difusor Lente 30°	DF1T Difusor Transparente	DF1SOE* Difusor Semi-Opalino Difusor Semi-Opal	DF1F Difusor Fosco Difusor Mate	DF1OE* Difusor Opalino Difusor Opal	DF1PT DF1PT.3 Difusor Preto Difusor Negro



*Disponível em:
*Disponible en:

DF1SOE.3 DF1OE.3	DF1SOE.10 DF1OE.10	DF1SOE.20 DF1OE.20	DF1SOE.30 DF1OE.30	DF1SOE.40 DF1OE.40	DF1SOE.50 DF1OE.50

PERFIS DE BARRAMENTO

PERFIL FALCO



Potência máxima 32W/mt
 Aplicação: Gesso
 Aplicación: Yeso

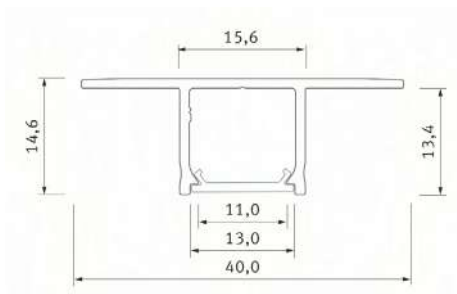

Ref.	Cor Color
PFA8731	Anodizado Anodizado
PFA8732	Lacado Branco Laca Blanco
PFA8737	Não Anodizado No Anodizado
PFA8738	Lacado Preto Laca Negro
PFA8731.3	Anodizado 3mt Anodizado 3mt
PFA8732.3	Lacado Branco 3mt Laca Blanco 3mt
PFA8737.3	Não Anodizado 3mt No Anodizado 3mt
PFA8738.3	Lacado Preto 3m Laca Negro 3m

	TP8731	Topo PL Cinza Tapa PL Gris
	TP8732	Topo PL Branco Tapa PL Blanco
	TP8738	Topo PL Preto Tapa PL Negro



ACESSÓRIOS DISPONÍVEIS | ACCESORIOS DISPONIBLES

Unões de ligação | Uniones



228521U

228521UA

228521UT

228521UA120

NOVO
NUEVO

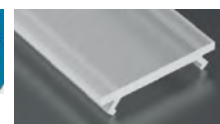

DF10B

Difusor de Obra
 Difusor de construcción

DIFUSORES



DF1LT | DF1LT30

Difusor Lente 15°
 Difusor Lente 30°



DF1T

Difusor
 Transparente



DF1SOE*

Difusor
 Semi-Opalino
 Difusor Semi-Opal

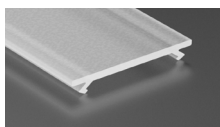

DF1F

Difusor Fosco
 Difusor Mate

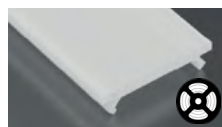

DF1OE*

Difusor Opalino
 Difusor Opal

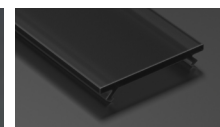

DF1PT | DF1PT.3

Difusor Preto
 Difusor Negro



*Disponível em:
 *Disponible en:

VARA
3m

10m

20m

30m

40m

50m

DF1SOE.3 DF1SOE.10 DF1SOE.20 DF1SOE.30 DF1SOE.40 DF1SOE.50
 DF1OE.3 DF1OE.10 DF1OE.20 DF1OE.30 DF1OE.40 DF1OE.50

PERFIS DE BARRAMENTO

PERFIL TOMAR



Aplicação | Aplicación:
Encastre | Empotrado

Perfil de alumínio para encastrar, concebido para fitas led com 15 mm de largura.

Perfil led empotrable, diseñado para tiras led de 15 mm de ancho.

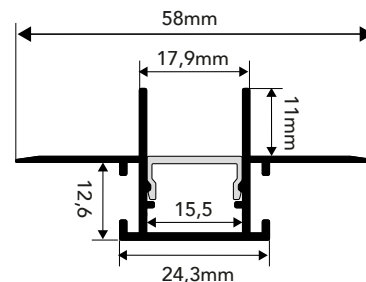

Modelo	Ref.	Descrição	Ref.	Acessórios
TOMAR	PFA81191	Anodizado c/ Difusor Semi-Opalino Anodizado c/ Difusor Semi-Opalino		TP81192 Topo Plástico Cinza Topo Plástico Gris
	PFA81192	Branco c/ Difusor Semi-Opalino Blanco c/ Difusor Semi-Opalino		

PERFIL MOTTA

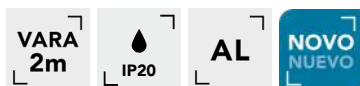
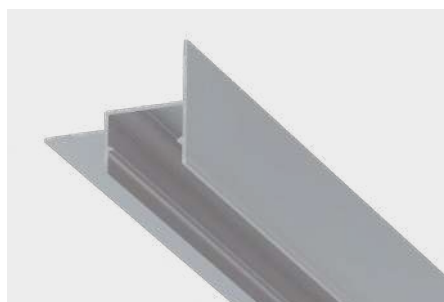

Aplicação | Aplicación:
Encastre | Empotrado

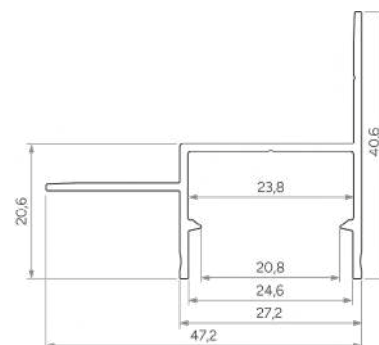

Ref.	Cor Color	Ref.	Cor Color
PFA19987	■ Não Anodizado No Anodizado		TPF19981 ■ Topo PL Cinza Tapa PL Gris
PFA19982	□ Lacado Branco Laca Blanco		TPF19982 □ Topo PL Branco Tapa PL Blanco
			TPF19987 ■ Topo Lacado Cinza Tapa Lacado Gris

DIFUSORES

DF3T Difusor Transparente	DF3SOE* Difusor Semi-Opalino Difusor Semi-Opal	DF3OE* Difusor Opalino Difusor Opal	DF3PT DF3PT.3 3MT Difusor Preto Difusor Negro



*Disponível em:
*Disponible en:

DF3SOE.3 DF3OE.3	DF3SOE.10 DF3OE.10	DF3SOE.20 DF3OE.20	DF3SOE.30 DF3OE.30	DF3SOE.40 DF3OE.40	DF3SOE.50 DF3OE.50

APLICAÇÃO | APLICACIÓN

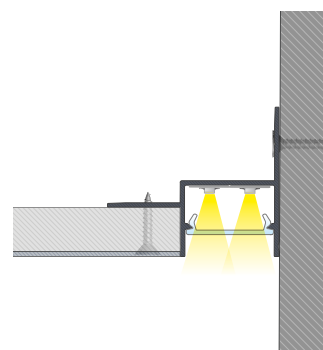

PERFIS DE BARRAMENTO

PERFIL PLATO



Potência máxima 45W/mt
 Aplicação: Encastrar / Gesso
 Aplicación: Empotrar / Yeso

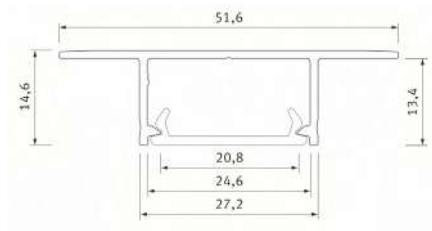

Ref.	Cor Color
PFA8761	Anodizado Anodizado
PFA8762	Lacado Branco Laca Blanco
PFA8767	Não Anodizado No Anodizado
PFA8768	Lacado Preto Laca Negro
PFA8761.3	Anodizado 3mt Anodizado 3mt
PFA8762.3	Lacado Branco 3mt Laca Blanco 3mt
PFA8767.3	Não Anodizado 3mt No Anodizado 3mt
PFA8768.3	Lacado Preto 3m Laca Negro 3m

	TP8761	Topo PL Cinza Tapa PL Gris
	TP8762	Topo PL Branco Tapa PL Blanco
	TP8768	Topo PL Preto Tapa PL Negro

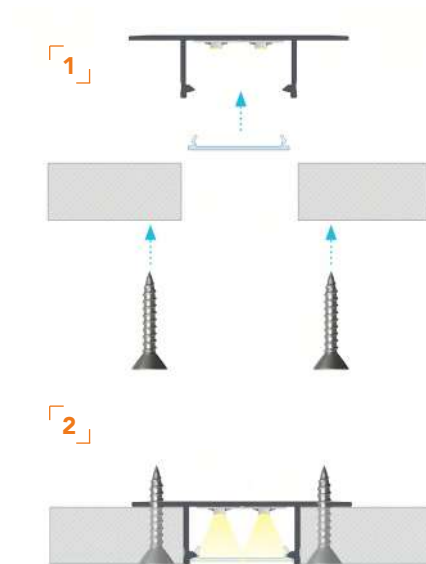

DIFUSORES

DF3T Difusor Transparente	DF3SOE* Difusor Semi-Opalino Difusor Semi-Opal	DF3OE* Difusor Opalino Difusor Opal	DF3PT DF3PT.3 3MT Difusor Preto Difusor Negro	DF3PTE* Preto Mate Negro mate	DF3OB Difusor de Obra Difusor de construcción



*Disponível em:
 *Disponible en:

DF3PTE	DF3SOE.3 DF3OE.3	DF3SOE.10 DF3OE.10 DF3PTE.10	DF3SOE.20 DF3OE.20	DF3SOE.30 DF3OE.30	DF3SOE.40 DF3OE.40	DF3SOE.50 DF3OE.50 DF3PTE.50

PERFIS DE BARRAMENTO

PERFIL SAFARUJO

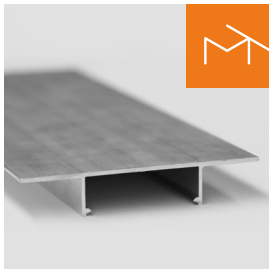

VARA 3m	VARA 2m	AL	Aplicação / Aplicación: Encastrar / Gesso Empotrar / Yeso
Ref.	Cor Color		
PFA8667	■	Não Anodizado No Anodizado	
PFA8667.3	■	Não Anodizado 3mt No Anodizado 3mt	

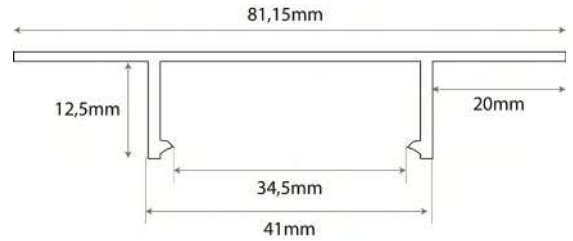

* Possibilidade de fornecimento em 4 e 6 metros.
* Posibilidad de suministro en 4 y 6 metros.

DIFUSORES | DIFUSORES

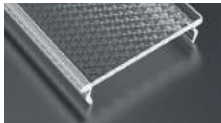

DF4P
Difusor Prismático
(Baixo UGR)

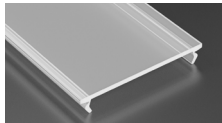

DF4SO | DF4SO.3
Difusor Semi-Opalino
Difusor Semi-Opal

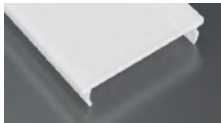

DF4O | DF4O.3
Difusor Opalino
Difusor Opal



Aplicação em obra
Aplicación en la construcción



Acabamento Final
Toque Final

PERFIL MOGOS

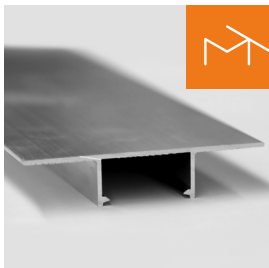

VARA 3m	VARA 2m	AL	Aplicação / Aplicación: Encastrar / Gesso Empotrar / Yeso
Ref.	Cor Color		
PFA8657	■	Não Anodizado No Anodizado	
PFA8657.3	■	Não Anodizado 3mt No Anodizado 3mt	

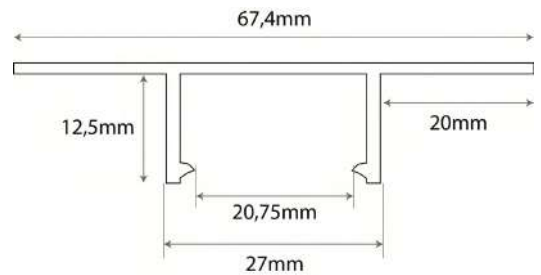

* Possibilidade de fornecimento em 4 e 6 metros.
* Posibilidad de suministro en 4 y 6 metros.

DIFUSORES

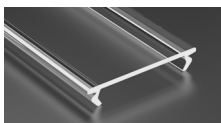

DF3T
Difusor Transparente

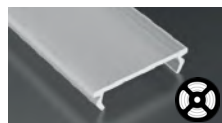

DF3SOE*
Difusor Semi-Opalino
Difusor Semi-Opal



DF3OE*
Difusor Opalino
Difusor Opal



DF3PT | DF3PT.3 3MT
Difusor Preto
Difusor Negro

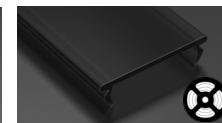

DF3PTE*
Preto Mate
Negro mate



DF3OB
Difusor de Obra
Difusor de construcción



*Disponível em:
*Disponible en:

VARA 2m	VARA 3m	10m	20m	30m	40m	50m
DF3PTE	DF3SOE.3 DF3OE.3	DF3SOE.10 DF3OE.10 DF3PTE.10	DF3SOE.20 DF3OE.20	DF3SOE.30 DF3OE.30	DF3SOE.40 DF3OE.40	DF3SOE.50 DF3OE.50 DF3PTE.50

Perfil de alumínio para embutir em teto de gesso cartonado. A aplicação deste perfil é realizada com abas por cima da placa de gesso de forma a ficar sem elementos de alumínio visíveis à vista.

Perfil de aluminio para empotrar en techo de pladur. La aplicación de este perfil se realiza con solapas sobre la placa de yeso para que no queden elementos de aluminio a la vista.

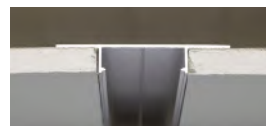

Aplicação em obra
Aplicación en la construcción



Acabamento Final
Toque Final



PERFIS DE BARRAMENTO

PERFIL SUBLI



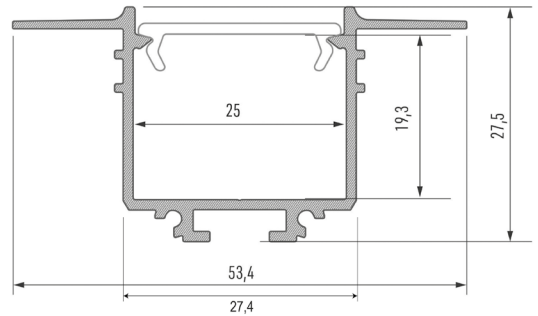

VARA 2m AL CORTE 27,4mm

Potência máxima
Potencia máxima: 46,2W/mt
Aplicação | Aplicación:
Encastrar / Gesso | Empotrar / Yeso



Ref.	Cor Color
PFA8241	Anodizado Anodizado
PFA8242	Lacado Branco Laca Blanco

	TP8241  Topo AL Cinza Tapa AL Gris
	TP8242  Topo AL Branco Tapa AL Blanco

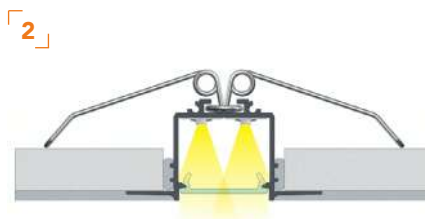
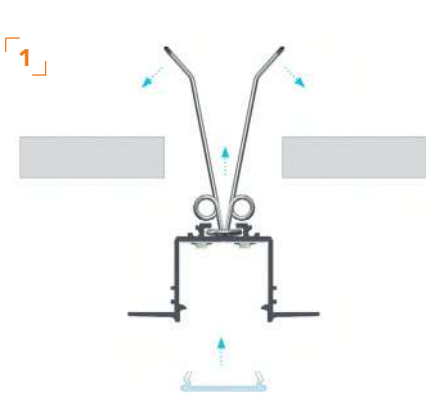





ACESSÓRIOS DISPONÍVEIS | ACCESORIOS DISPONIBLES

Unões de ligação | Uniones

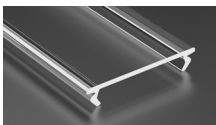
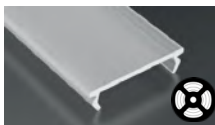

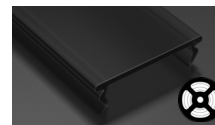





DIFUSORES

					
DF3T Difusor Transparente	DF3SOE* Difusor Semi-Opalino Difusor Semi-Opal	DF3OE* Difusor Opalino Difusor Opal	DF3PT DF3PT.3 3MT Difusor Preto Difusor Negro	DF3PTE* Preto Mate Negro mate	DF3OB Difusor de Obra Difusor de construcción



*Disponível em:
*Disponible en:

						
DF3PTE	DF3SOE.3 DF3OE.3	DF3SOE.10 DF3OE.10 DF3PTE.10	DF3SOE.20 DF3OE.20	DF3SOE.30 DF3OE.30	DF3SOE.40 DF3OE.40	DF3SOE.50 DF3OE.50 DF3PTE.50

PERFIS DE BARRAMENTO

PERFIL SORGA



VARA 2m	AL	CORTE 87,6mm
------------	----	-----------------

Potência máxima
Potencia máxima: 105W/mt
Aplicação | Aplicación:
Encastrar / Gesso
Empotrar / Yeso

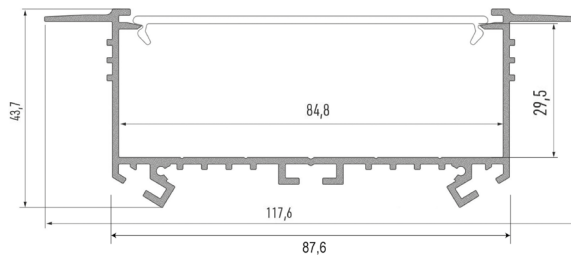

Ref.	Cor Color
PFA8251	Anodizado Anodizado
PFA8252	Lacado Branco Laca Blanco

	TP8251	Topo AL Cinza Tapa AL Gris
	TP8252	Topo AL Branco Tapa AL Blanco

O perfil Sorga é um perfil de encastrar capaz de suportar até 6 fitas de led de 12 mm.

Após a aplicação, o perfil fica sem as abas de remate à vista, visto estas serem barradas.

El perfil Sorga es un perfil de empotrar capaz de soportar hasta 6 tiras LED de 12 mm. Después de la aplicación, el perfil no tiene a la vista las solapas de acabado, ya que están enrejadas.

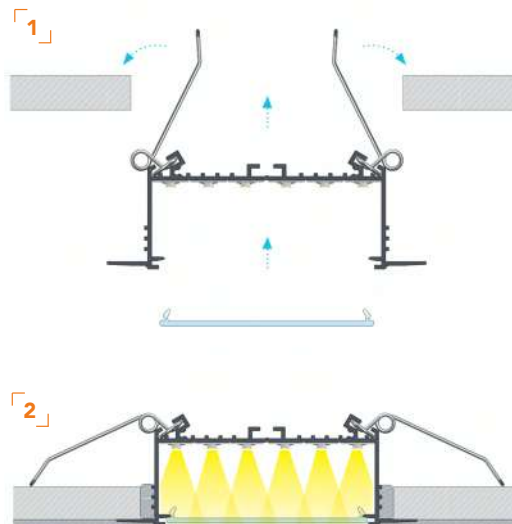

ACESSÓRIOS DISPONÍVEIS | ACCESORIOS DISPONIBLES

Unões de ligação | Uniones

228521U	228521UA	228521UT	228521UA120	Molas para perfil Clip metálico 228522

DIFUSORES

DF11T Difusor Transparente	DF11SO Difusor Semi-Opalino Difusor Semi-Opal	DF11O Difusor Opalino Difusor Opal



PERFIL MÉRTOLA



Aplicação | Aplicación:
Encastre Barramento
Empotrar Barramiento

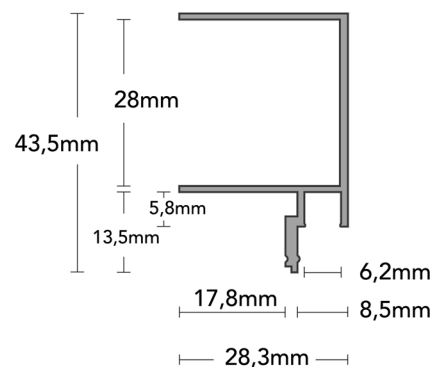

Ref.	Cor Color
PFG02050	Anodizado Anodizado
PFG02056	Anodizado Preto Anodizado Negro

	DFG00106	Difusor Semi-Opalino Difusor Semi-Opal
---	-----------------	---

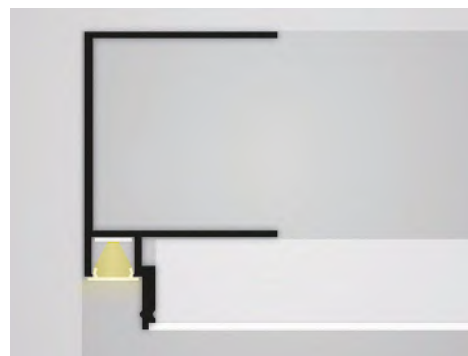

PERFIS DE BARRAMENTO

PERFIL APA 12



VARA 2m AL

Potência máxima
Potencia máxima: 43,4W/mt
Aplicação | Aplicación:
Gesso | Yeso

Ref.	Cor Color
PFA841	Anodizado Anodizado
PFA842	Lacado Branco Laca Blanco

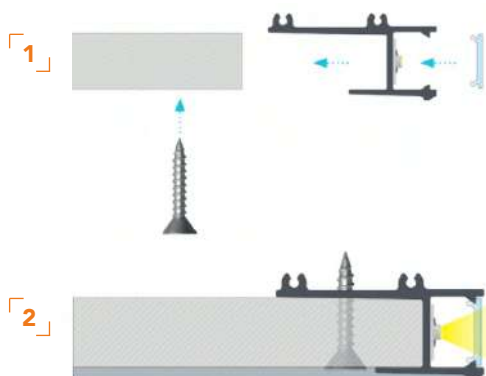
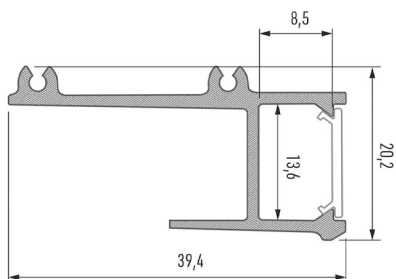

PERFIL IPA 12



VARA 2m AL

Potência máxima
Potencia máxima: 43,4W/mt
Aplicação | Aplicación:
Gesso | Yeso

Ref.	Cor Color
PFA8261	Anodizado Anodizado
PFA8262	Lacado Branco Laca Blanco

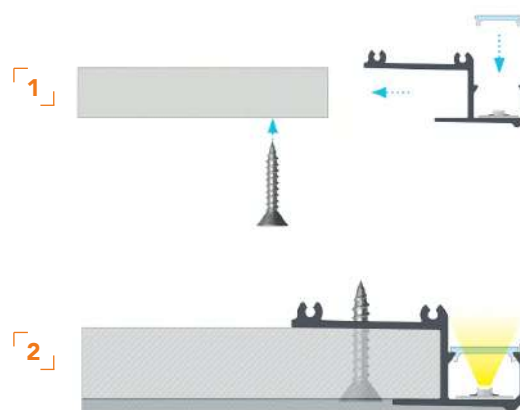
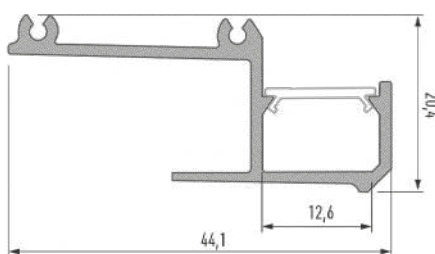

Perfil para aplicação em gesso cartonado de 12 mm para efeitos decorativos. Consulte a nossa ficha técnica para ver o modo de aplicação do perfil. Perfil para aplicación en pladur de 12 mm para efectos decorativos. Consulta nuestra ficha técnica para ver cómo aplicar el perfil.

DIFUSORES

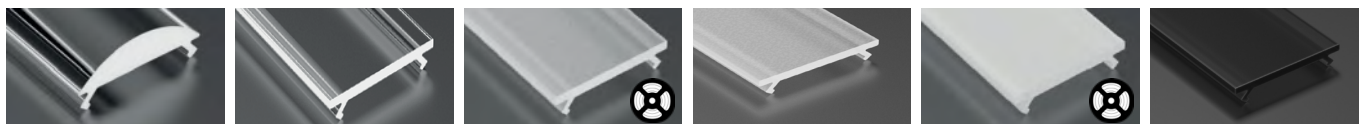

DF1LT DF1LT30 Difusor Lente 15° Difusor Lente 30°	DF1T Difusor Transparente	DF1SOE* Difusor Semi-Opalino Difusor Semi-Opal	DF1F Difusor Fosco Difusor Mate	DF1OE* Difusor Opalino Difusor Opal	DF1PT DF1PT.3 Difusor Preto Difusor Negro
--	-------------------------------------	---	--	--	--



*Disponível em:
*Disponible en:



DF1SOE.3 DF1SOE.10 DF1SOE.20 DF1SOE.30 DF1SOE.40 DF1SOE.50
DF1OE.3 DF1OE.10 DF1OE.20 DF1OE.30 DF1OE.40 DF1OE.50

PERFIS DE BARRAMENTO

PERFIL BORBA

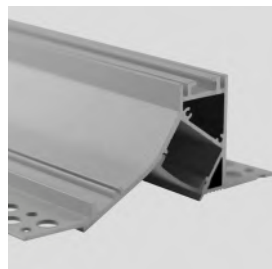

Aplicação:
Gesso / Sanca
Aplicación:
Yeso / Moldura

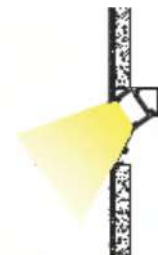
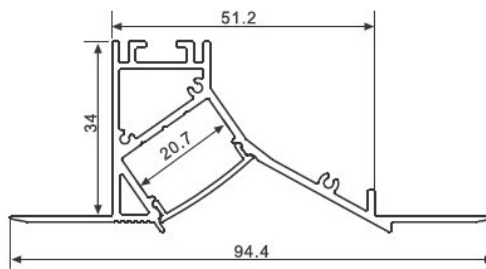

Ref.	Cor Color		
PFA14802	<input type="checkbox"/> Branco c/ Difusor Semi-Opalino Blanco c/ Difusor Semi-Opalino		TP14802 <input type="checkbox"/> Topo AL Branco Dir. Tapa AL Blanco Dcho.
PFA141382	<input checked="" type="checkbox"/> Perfil Lacado Branco s/Difusor Perfil Anodizado s/ Difusor		TPF14802 <input type="checkbox"/> Topo AL Branco Esq. Tapa AL Blanco Izq.
TORRE DE BORBA	DF9SO* <input type="checkbox"/> Difusor Semi-Opalino Difusor Semi-Opalino	*Disponível em Disponible en:	
	DF9PT* <input checked="" type="checkbox"/> Difusor Preto Difusor Negro		
	DFSL9* <input type="checkbox"/> Difusor Opalino Silicone Difusor Opalino Silicona		
		DF9SO	DF9SO.10
		DF9PT	DF9PT.10
		DFSL9	DFSL9.10
			DF9SO.50
			DF9PT.50
			DFSL9.50

PERFIL DUO



Aplicação: Encastrar
Aplicación: Empotrar

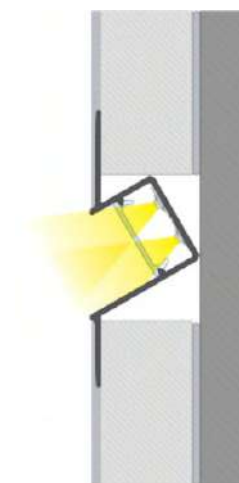
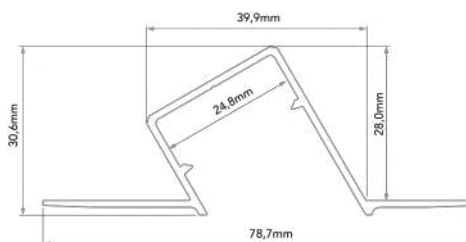

Ref.	Cor Color		
PFA2861	<input checked="" type="checkbox"/> Anodizado Anodizado		TP2861D Topo AL Cinza Dir. / Esq.
PFA2867	<input checked="" type="checkbox"/> Cru Cru		TP2861E Tapa AL Gris Dir. / Izq.
PFA2862	<input type="checkbox"/> Lacado Branco Lacado Blanco		TP2862D Topo AL Branco Dir. / Esq.
			TP2862E Tapa AL Blanco Dir. / Izq.

DIFUSORES

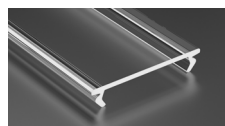

DF3T
Difusor
Transparente

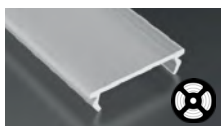

DF3SOE*
Difusor
Semi-Opalino
Difusor Semi-Opal

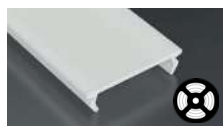

DF3OE*
Difusor Opalino
Difusor Opal



DF3PT
DF3PT.3 3MT
Difusor Preto
Difusor Negro

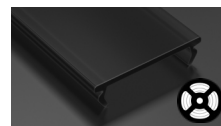

DF3PTE*
Preto Mate
Negro mate



*Disponível em:
*Disponible en:



DF3PTE



DF3SOE.3
DF3OE.3



DF3SOE.10
DF3OE.10
DF3PTE.10



DF3SOE.20
DF3OE.20



DF3SOE.30
DF3OE.30



DF3SOE.40
DF3OE.40



DF3SOE.50
DF3PTE.50

PERFIS DE BARRAMENTO

PERFIL VEDA



Potência máxima /Potencia máxima:
173,6W/mt
Aplicação | Aplicación:
Gesso / Sanca | Yeso / Moldura

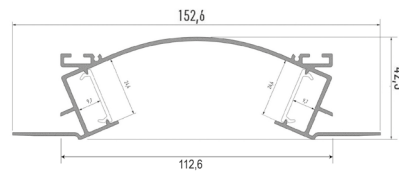

Ref.	Cor Color
PFA8211	Anodizado Anodizado
PFA8212	Lacado Branco Laca Blanco

TP8211	Topo AL Cinza Tapa AL Gris
TP8212	Topo AL Branco Tapa AL Blanco

PERFIL TOPO



Potência máxima Potencia máxima:
102,2W/mt
Aplicação | Aplicación:
Gesso / Sanca | Yeso / Moldura

TP8311D	Topo AL Cinza Dir. Tapa AL Gris Dcho.
TP8311E	Topo AL Cinza Esq. Tapa AL Gris Izq.
TP8312D	Topo AL Branco Dir. Tapa AL Blanco Dcho.
TP8312E	Topo AL Branco Esq. Tapa AL Blanco Izq.

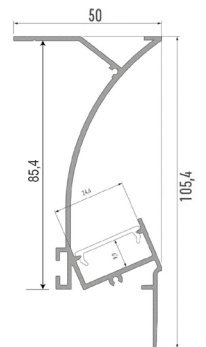

Ref.	Cor Color
PFA8311	Anodizado Anodizado
PFA8312	Lacado Branco Laca Blanco

PERFIL PERO



Potência máxima Potencia máxima: 102,2W/mt
Aplicação | Aplicación: Gesso / Sanca | Yeso / Moldura

TP8341D	Topo AL Cinza Dir. Tapa AL Gris Dcho.
TP8341E	Topo AL Cinza Esq. Tapa AL Gris Izq.
TP8342D	Topo AL Branco Dir. Tapa AL Blanco Dcho.
TP8342E	Topo AL Branco Esq. Tapa AL Blanco Izq.

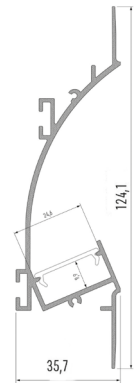

Ref.	Cor Color
PFA8341	Anodizado Anodizado
PFA8342	Lacado Branco Laca Blanco
PFA8341.3	Anodizado 3mt Anodizado 3mt

Perfis de encastre para gesso cartonado, sem aba visível após aplicação. Ideais para tetos falsos. Perfis de encaixe para placas de yeso laminado, sin reborde visible tras la aplicación. Ideais para falsos techos.

ACESSÓRIOS DISPONÍVEIS | ACCESORIOS DISPONIBLES

Unões de ligação | Uniones

Mola p/ perfil
Clip metálico



228521U



228521UA



228521UT



228522

DIFUSORES

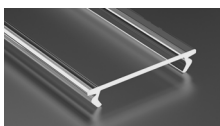

DF3T

Difusor
Transparente

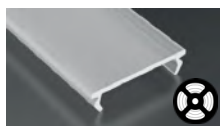

DF3SOE*

Difusor
Semi-Opalino
Difusor Semi-Opal

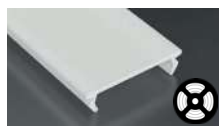

DF3OE*

Difusor Opalino
Difusor Opal



DF3PT
DF3PT.3 3MT

Difusor Preto
Difusor Negro

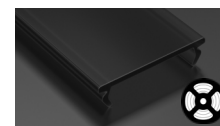

DF3PTE*

Preto Mate
Negro mate

*Disponível em: Consultar na página anterior
*Disponible en: Consultar en la página anterior.



PERFIS DE BARRAMENTO

PERFIL MONSANTO



VARA
2m

AL

Aplicação | Aplicación:
Encastre Barramento
Empotrar Barramiento

Ref.	Cor Color
PFG02040	Anodizado Anodizado
PFG03040	Anodizado Branco Anodizado Blanco

	DFG00084 Difusor Semi-Opalino Difusor Semi-Opal
---	--

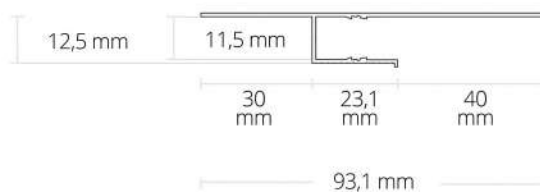

Perfil de barramento idealizado para projetar uma luz indireta, ideal para iluminação de sancas e rodapés.

Perfil bus diseñado para proyectar luz indirecta, ideal para iluminar molduras y rodapiés.

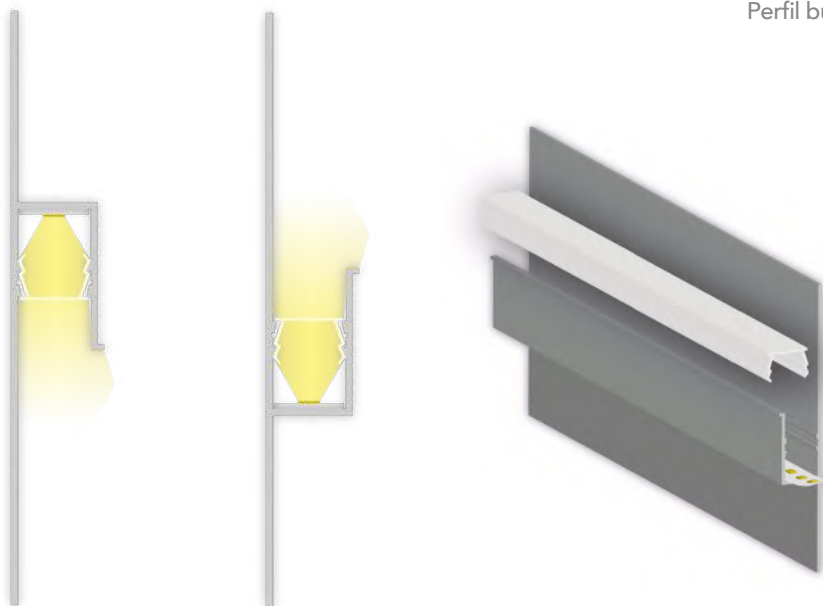



Os perfis de suspensão permitem a criação de linhas de luz com a altura desejada. Resultam em luminárias decorativas e minimalistas.

Los perfiles de suspensión permiten crear líneas de luz con la altura deseada. Dan como resultado luminarias coloridas y minimalistas.

PERFIS DE SUSPENSÃO

Perfiles de Suspensión

DIFUSOR REFLETOR

EXCLUSIVO PERFIS DULIO E CLARO

EXCLUSIVO PERFILES DULIO Y CLARO

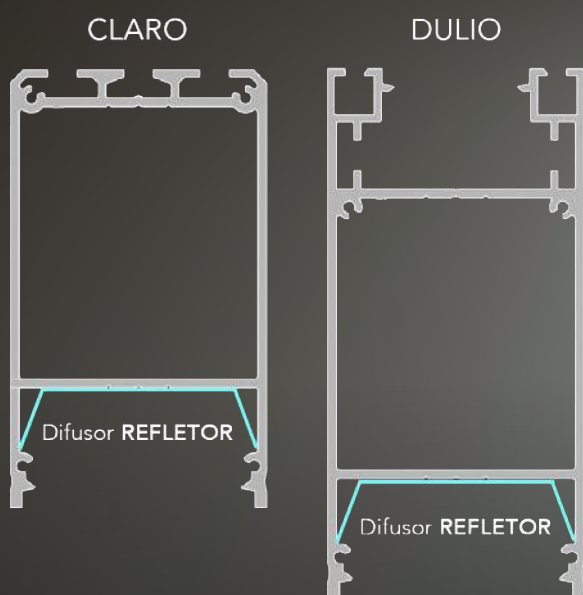

REF. DFRF4

Aumenta significativamente o fluxo luminoso que sai do perfil, permite uma fácil montagem das fitas de led.

Aumenta notablemente el flujo luminoso que sale del perfil, permite un fácil montaje de tiras de led.

PERFIS DE SUSPENSÃO

PERFIL JAZ DUO

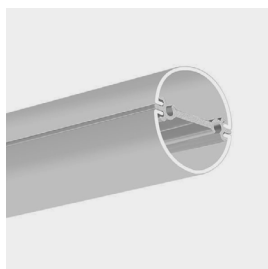
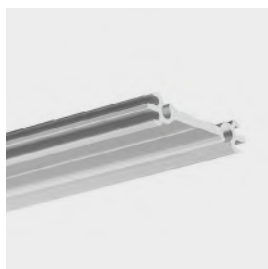

VARA
2m



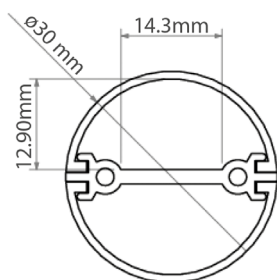

AL

Aplicação | Aplicación:
Suspensão | Suspensión



Ref. Cor | Color

PFK0788 ■ Anodizado
Anodizado

Ref.	Cor Color
 TPK42641 ■ Topo Simples Tapa Simple	
 TPK42644 ■ Topo Eletrificado com 2 saídas Tapa Electrificada con 2 salidas	
 TPK42633 ■ Conjunto para suspensão Juego de suspensión	
 ACK42647 ■ Conjunto para suspensão Juego de suspensión	
 ACK42659 ■ Conjunto para suspensão Juego de suspensión	

Iluminação bidirecional (linha de luz dupla face) com possibilidade de montagem vertical, horizontal ou diagonal. Idealmente utilizado em salas amplas com tetos altos. Pode ser usado com fitas de LED até 14mm de largura. Tem uma gama alargada de acessórios adicionais.

Iluminación bidireccional (línea de luz de doble cara) con posibilidad de montaje vertical, horizontal o diagonal. Idealmente utilizado en habitaciones grandes con techos altos. Se puede utilizar con tiras LED de hasta 14mm de ancho. Dispone de una amplia gama de accesorios adicionales.

DIFUSORES

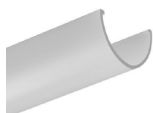

DFK17163
Difusor Opalino
Difusor Opal

Para um bom funcionamento deverão ser colocados 2 difusores.
Para un buen funcionamiento se deben colocar 2 difusores.

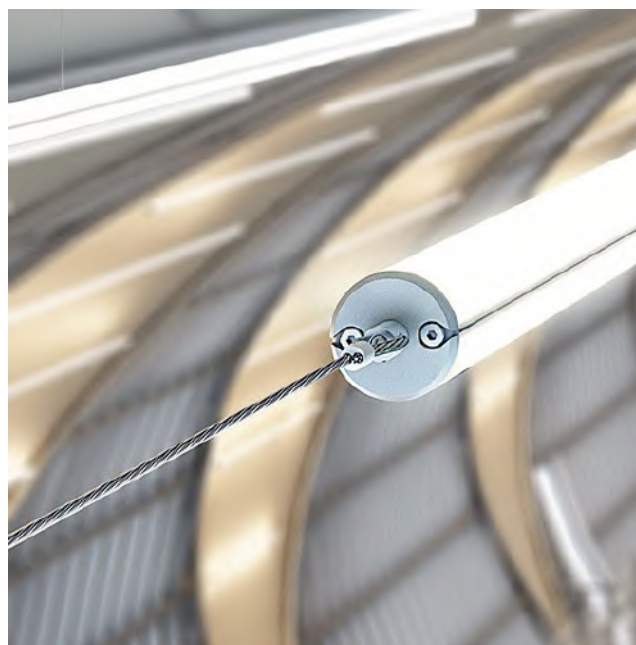
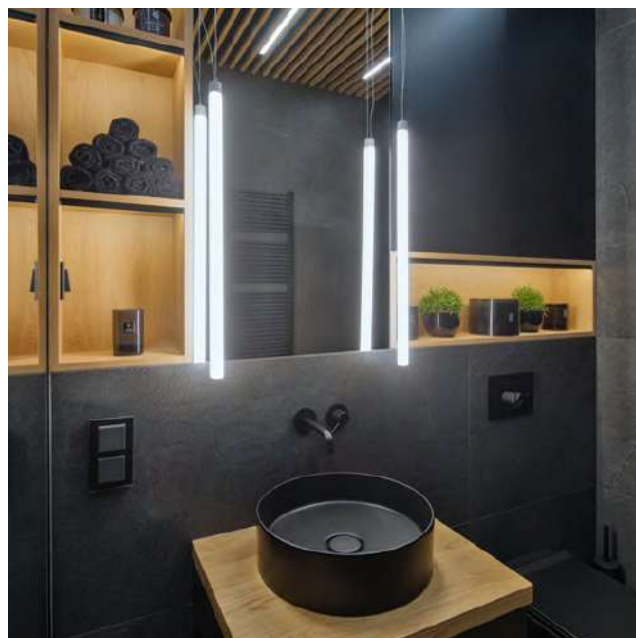

PERFIS DE SUSPENSÃO

PERFIL DULIO



Potência máxima da fita:
superior: 38W/mt | inferior: 68W/mt
Potencia máxima da tira
superior: 38W/mt | inferior: 68W/mt
Aplicação | Aplicación: Suspensão | Suspensión

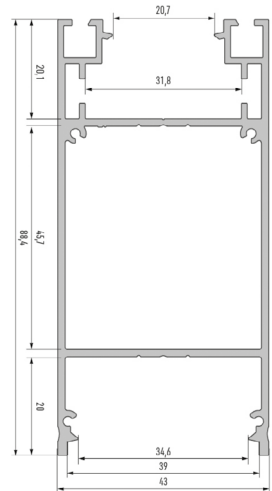

Ref.	Cor Color		
PFA5351	Anodizado Anodizado		TP5351 Topo AL Cinza Tapa AL Gris
PFA5352	Lacado Branco Laca Blanco		TP5352 Topo AL Branco Tapa AL Blanco
PFA5358	Lacado Preto Laca Negro		TP5358 Topo AL Preto Tapa AL Negro

É um perfil de suspensão, com iluminação bilateral, com possibilidade de colocar fonte de alimentação no interior. Projeta luz para cima e para baixo. Es un perfil de suspensión, con iluminación bilateral, con posibilidad de colocar una fuente de alimentación en su interior. Los proyectos se iluminan hacia arriba y hacia abajo.

ACESSÓRIOS DISPONÍVEIS | ACCESORIOS DISPONIBLES

Unões de ligação | Uniones



Mola p/ perfil
Clip metálico



228522

Suspensões p/ perfil
Suspensiones p/ perfil



228521.Y 25CM
228521.Y1 12,5CM

DIFUSORES CIMA | DIFUSORES ARRIBA

DF3T Difusor Transparente	DF3SOE* Difusor Semi-Opalino Difusor Semi-Opal	DF3OE* Difusor Opalino Difusor Opal	DF3PT DF3PT.3 3MT Difusor Preto Difusor Negro	DF3PTE* Preto Mate Negro mate



*Disponível em:
*Disponible en:

DF3PTE	DF3SOE.3 DF3OE.3	DF3SOE.10 DF3OE.10 DF3PTE.10	DF3SOE.20 DF3OE.20	DF3SOE.30 DF3OE.30	DF3SOE.40 DF3OE.40	DF3SOE.50 DF3OE.50 DF3PTE.50

DIFUSORES BAIXO | DIFUSORES BAJO

DF4A Difusor Alumínio Difusor Aluminio	DF4P DF4P.3 Difusor Prismático (Baixo UGR)	DF4SO DF4SO.3 Difusor Semi-Opal Difusor Semi-Opal	DF4O DF4O.3 Difusor Opalino Difusor Opal	DF4LM Difusor de Lamelas* Difusor de Láminas*

RECOMENDADO

Fonte Slim
Ref.:
201281.2160



PERFIS DE SUSPENSÃO

PERFIL FIXO



Aplicação | Aplicación: Suspensão ou Saliente

É um perfil de suspensão com possibilidade de colocar fonte de alimentação no interior.

Es un perfil de suspensión con posibilidad de colocar una fuente de alimentación en su interior.

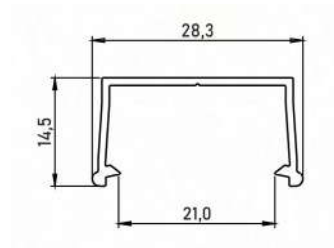

Modelo	Ref.	Cor Color
FIXO	PFA41051	Anodizado Anodizado
	PFA41058	Preto Negro
FIXO M1	PFA41061	Anodizado Anodizado
	PFA41068	Preto Negro

ACESSÓRIOS RECOMENDADOS | ACCESORIOS RECOMENDADOS

	Ref.	Cor Color
FIXO M1	TP41061AL	Topo AL Anodizado Tapa AL Anodizado
	TP41061	Topo PL Anodizado Tapa PL Anodizado
	TP41068AL	Topo AL Preto Tapa AL Negro
	TP41068	Topo PL Preto Tapa PL Negro
	FX110	Fixador Metal Fijador Metálico

DIFUSORES

DF3T Difusor Transparente	DF3SOE* Difusor Semi-Opalino Difusor Semi-Opal	DF3OE* Difusor Opalino Difusor Opal	DF3PT DF3PT.3 3MT Difusor Preto Difusor Negro



*Disponível em:
*Disponible en:

VARA 3m	10m	20m	30m	40m	50m
DF3SOE.3 DF3OE.3	DF3SOE.10 DF3OE.10	DF3SOE.20 DF3OE.20	DF3SOE.30 DF3OE.30	DF3SOE.40 DF3OE.40	DF3SOE.50 DF3OE.50

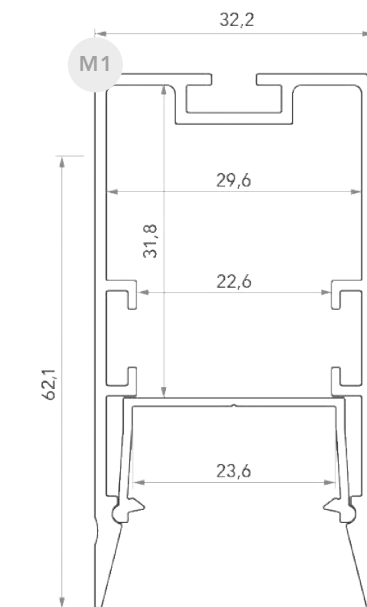

APLICAÇÃO | APLICACIÓN

Instalação do perfil FIXO com topos e alimentação eléctrica oculta no interior do perfil de montagem FIXO M1 (PFA41061).

Instalación del perfil FIXO con topes y alimentación eléctrica oculta en el interior del perfil de montaje FIXO M1 (PFA41061).

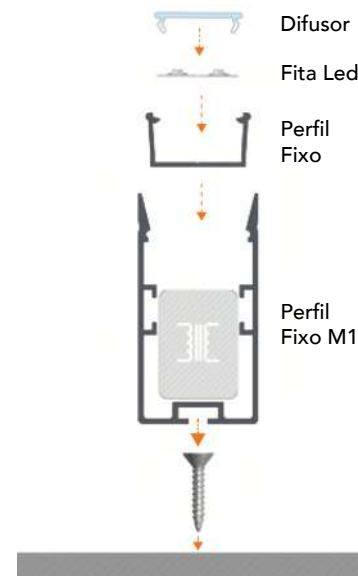

PERFIS DE SUSPENSÃO

PERFIL CLARO



Potência máxima | Potencia máxima: 70W/mt
 Aplicação | Aplicación:
 Suspensão | Suspensión

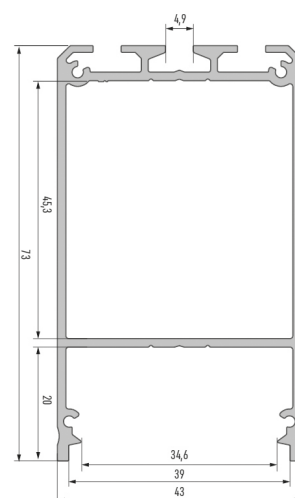

Ref.	Cor Color
PFA1361	Anodizado Anodizado
PFA1362	Lacado Branco Laca Blanco
PFA1368	Lacado Preto Laca Negro
PFA1361.3	Anodizado 3mt Anodizado 3mt
PFA1362.3	Lacado Branco 3mt Laca Blanco 3mt
PFA1368.3	Lacado Preto 3mt Laca Negro 3mt

	TP1361	Topo AL Cinza Tapa AL Gris
	TP1362	Topo AL Branco Tapa AL Blanco
	TP1368	Topo AL Preto Tapa AL Negro

É um perfil de suspensão com possibilidade de colocar fonte de alimentação no interior. Es un perfil de suspensión con posibilidad de colocar una fuente de alimentación en su interior.

ACESSÓRIOS RECOMENDADOS | ACCESORIOS RECOMENDADOS



Fonte Slim Ref.: 2018010.2100

ACESSÓRIOS DISPONÍVEIS | ACCESORIOS DISPONIBLES

Suspensões para perfil | Suspensiones de perfil



228521.125

228521
228521.3 3mt
228521.5 5mt

228521A

Uniões de ligação | Uniones



228521U

228521UA



228521UA120

228521UT

DIFUSORES

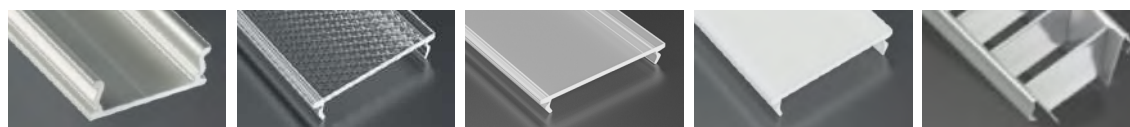

DF4A

DF4P | DF4P.3

DF4SO | DF4SO.3

DF4O | DF4O.3

DF4LM

Difusor Alumínio
Difusor Aluminio

Difusor Prismático
(Baixo UGR)

Difusor
Semi-Opalino
Difusor Semi-Opal

Difusor Opalino
Difusor Opal

Difusor de Lamelas*
Difusor de Láminas*

PERFIS DE SUSPENSÃO

PERFIL FOLDO



Aplicação | Aplicación: Suspensão ou Saliente

Sistema com fonte de alimentação oculta dentro da caixa. O seu design exclusivo permite a manutenção da luminária e a substituição da fonte de alimentação sem remover a luminária da sua suspensão.

Sistema con fonte de alimentación oculta dentro de la caja. Su diseño exclusivo permite el mantenimiento de la luminaria y la sustitución de la fuente de alimentación sin necesidad de retirar la luminaria de su suspensión.

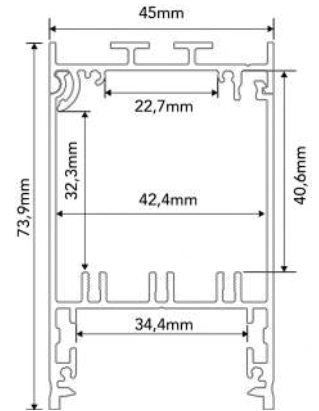

Modelo	Ref.	Cor Color	Ref.	
FOLDO	PFA11311	Anodizado Anodizado	TP11311	Topo PL Cinza Topo PL Gris
	PFA11311.3	Anodizado 3 Anodizado	TP11311AL	Topo AL Cinza Topo AL Gris
	PFA11318	Preto Negro	TP11318	Topo PL Preto Topo PL Negro
	PFA11318.3	Preto 3mt Negro 3mt	TP11318AL	Topo AL Preto Topo AL Negro
FOLDO M1	PM11311	Anodizado Anodizado	FXM136	Fixador de Metal Fijador de Metal
	PM11311.3	Anodizado 3mt Anodizado 3mt	228521	Kit Suspensão Kit de suspensión
	PM11318	Preto Preto		
	PM11318.3	Preto 3mt Preto 3mt		

DIFUSORES

DF4A Difusor Alumínio Difusor Aluminio	DF4P Difusor Prismático (Baixo UGR)	DF4SO DF4SO.3 Difusor Semi-Opalino Difusor Semi-Opal	DF4O DF4O.3 Difusor Opalino Difusor Opal

ACESSÓRIOS DISPONÍVEIS
ACCESORIOS DISPONIBLES

Uniões de ligação | Uniones



UM NOVO SERVIÇO MOTAKO

UN NUEVO SERVICIO

HIGH IMPACT LIGHTING

NEONS E LUMINÁRIAS
DE ALTA PROTEÇÃO
E ALTO IMPACTO

NEONES Y LUMINARIAS
DE ALTA PROTECCIÓN Y ALTO IMPACTO



O SEU PROJETO DE SONHO, O NOSSO SERVIÇO

EL PROYECTO DE SUS SUEÑOS, NUESTRO SERVICIO

PERSONALIZE AS CARACTERÍSTICAS DA SUA LUMINÁRIA

PERSONALICE LAS CARACTERÍSTICAS DE SU LUMINARIA

LUMINÁRIA
HIL



MODELOS DISPONÍVEIS MODELOS DISPONIBLES

Possibilidade de encher
uma grande variedade
dos nossos perfis.*

Posibilidad de rellenar una
gran variedad de nuestros
perfiles.*

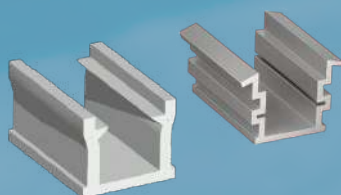

TEMPERATURA TEMPERATURA

— 2700K, 3000K, 4000K, 6000K
RGB, RGBW e CCT.

OPACIDADE OPACIDAD

— Transparente
— Opalino *Opal*

ACABAMENTO ACABADO

— Soft
— Rígido

*Sob consulta.



Crie linhas de luz no pavimento
em interior e exterior.

*Crea líneas de luz en el suelo en interior
y exterior.*

PERFIS DE PAVIMENTO

Perfiles de Pavimento

PERFIS DE PAVIMENTO

PERFIL TERRA



VARA 3m	VARA 2m	AL	CORTE 20mm
IP54	IK08		

Potência máxima
Potencia máxima: 23,5W/mt
Aplicação | Aplicación:
Pavimento | Piso

Ref.	Cor Color
PFA761	Anodizado Anodizado
PFA761.3	Anodizado 3mt Anodizado 3mt

	TP761	Topo PL Cinza Tapa PL Gris
	TPF761	Topo PL Cinza c/ furo Tapa PL Gris c/ pasacable

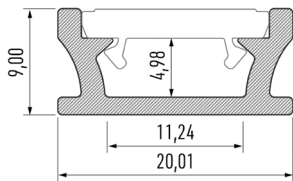

O perfil Terra é um perfil de pavimento e para efeitos decorativos. O seu difusor com efeito vedante retarda o envelhecimento da fita de Led e por isso pode ser aplicado em locais expostos a um grau de humidade mais elevado.

El perfil Terra es un perfil de suelo y decorativo. Su difusor con efecto sellador retrasa el envejecimiento de la tira LED y por tanto puede ser aplicado en lugares expuestos a un mayor grado de humedad.

PERFIL RUNO



VARA 3m	VARA 2m	AL	CORTE 20mm
IP54	IK08		

Potência máxima
Potencia máxima: 23,5W/mt
Aplicação | Aplicación:
Pavimento | Piso

Ref.	Cor Color
PFA7611	Anodizado Anodizado
PFA7611.3	Anodizado 3mt Anodizado 3mt

	TP7611	Topo PL Cinza Tapa PL Gris
	TPF7611	Topo PL Cinza c/ furo Tapa PL Gris c/ pasacable

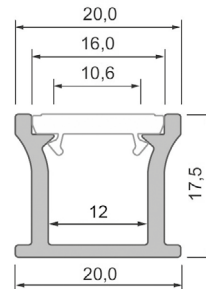

O perfil Runo é um perfil de pavimento com possibilidade de aplicação de fitas LED com IP67. O seu difusor com efeito vedante retarda o envelhecimento da fita de Led e por isso pode ser aplicado em locais expostos a um grau de humidade mais elevado.

El perfil Runo es un perfil de suelo con posibilidad de aplicar tiras LED con IP67. Su difusor con efecto sellador retrasa el envejecimiento de la tira LED y por tanto puede ser aplicado en lugares expuestos a un mayor grado de humedad.

DIFUSOR

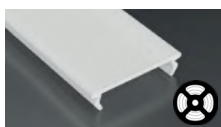

DF50 | DF50.3
Difusor Opalino
Difusor Opal

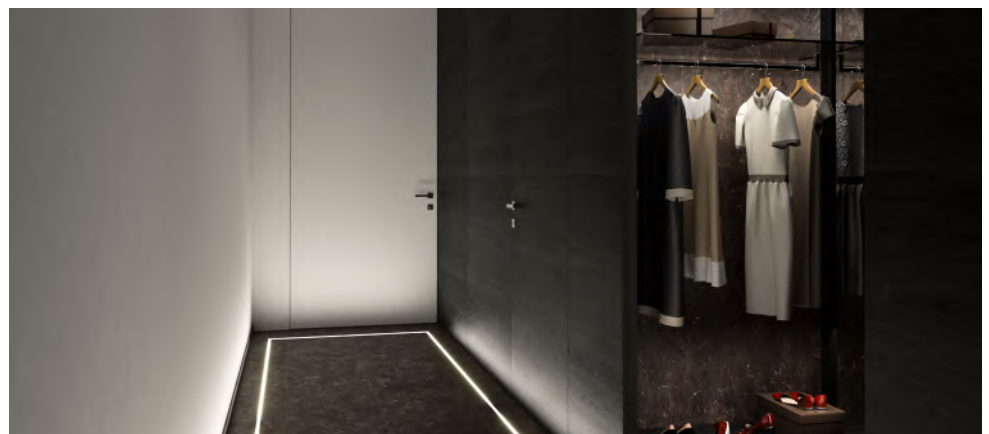

PERFIS DE PAVIMENTO

PERFIL STRADA

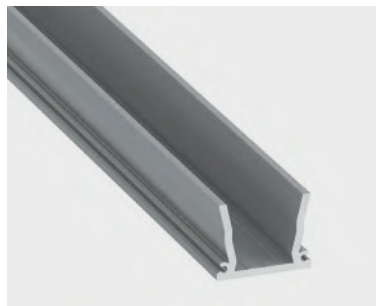

VARA 2m VARA 3m IK10 IP68 AL NOVO NUEVO

Aplicação | Aplicación: Pavimento | Piso

Sistema led de embutir, com capacidade de carga para passagem de veículos até 3,5 toneladas. Concebido para instalação em entradas de garagem, passeios e outras zonas que exijam linhas de iluminação de alta resistência.

Sistema de iluminación LED empotrable con capacidad de carga de hasta 3,5 toneladas. Diseñado para su instalación en entradas de vehículos, aceras y otras zonas que requieren iluminación de alta potencia.

Modelo	Ref.	Cor Color
STRADA	PFA7921	Anodizado Anodizado
	PFA7921.3	Anodizado 3mt Anodizado 3mt
STRADA M1	PFA7931	Anodizado Anodizado
	PFA7931.3	Anodizado 3mt Anodizado 3mt
STRADA M3	PFA7951	Anodizado Anodizado
	PFA7951.3	Anodizado 3mt Anodizado 3mt

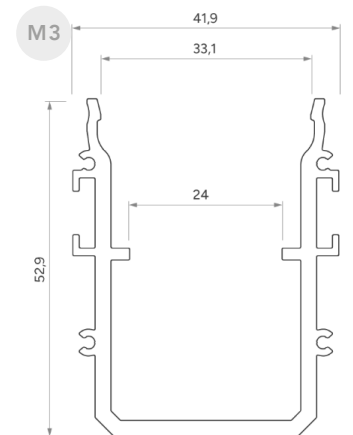
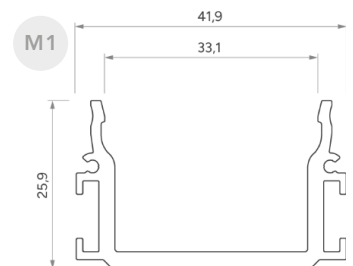
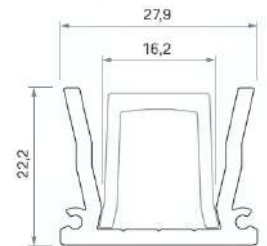

ACESSÓRIOS RECOMENDADOS | ACCESORIOS RECOMENDADOS

Modelo	Ref.	Descrição
STRADA	DF70SOLID DF70.3SOLID	Difusor Opalino Difusor Opalino Difusor Opal. 3mt Difusor Opal. 3mt
	TPS11081	Topo sólido p/Difusor Tapa sólida para/Perfil
	TPF7921 TP7921	Topo de AL c/ furo Tapa de AL s/ orificio Topo de AL s/ furo Tapa de AL c/orificio
	FX7921	Clip de fixação Clip de fijación
STRADA M1	TPF7931 TP7931	Topo de AL c/ furo Tapa de AL s/ orificio Topo de AL s/ furo Tapa de AL c/orificio
STRADA M3	TPF7951 TP7951	Topo de AL c/ furo Tapa de AL s/ orificio Topo de AL s/ furo Tapa de AL c/orificio
STRADA M1 + M3	TPF7931+51 TP7931+51	Topo de AL c/ furo Tapa de AL s/ orificio Topo de AL s/ furo Tapa de AL c/orificio

Unões de ligação | Uniones

228521U 228521UA

228521UT 228521UA120

Silicone Profissional
Silicona Profesional

Ref.: 2236776



APLICACIÓN | APLICACIÓN

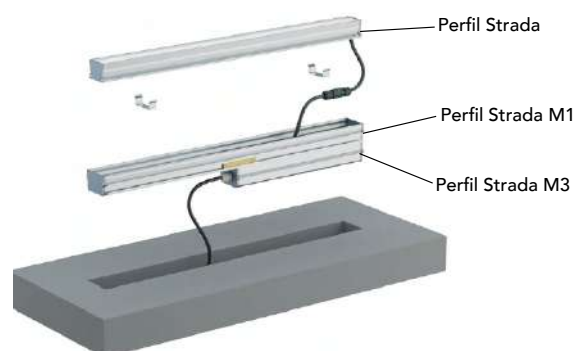

PERFIS DE PAVIMENTO

PERFIL MOUROS



Aplicação | Aplicación:
Encastre em pavimento
Empotrar em piso

Ref.	Cor Color
PFD5741	Anodizado Anodizado

 TPD1041	Topo Cinza Tapa Gris
---	-------------------------

DIFUSOR



DFD8085
Difusor Opalino
Difusor Opal

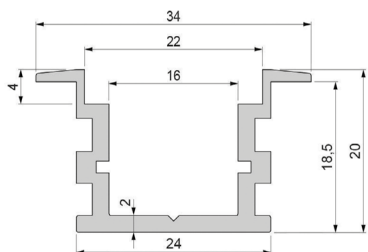

PERFIL MONSERRATE



Aplicação | Aplicación:
Pavimento | Piso

Ref.	Cor Color
PFD0741	Anodizado Anodizado

 TPD1031	Topo Cinza Tapa Gris
---	-------------------------

DIFUSOR



DFD8085
Difusor Opalino
Difusor Opal

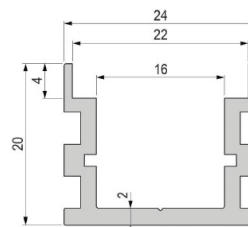

PERFIL SÃO JORGE



Aplicação | Aplicación:
Pavimento | Piso

Ref.	Cor Color
PFD5781	Anodizado Anodizado

 TPD1021	Topo Cinza Tapa Gris
---	-------------------------

 ACD0109	Espunja Espunja
---	--------------------

DIFUSOR



DFD8055
Difusor Opalino
Difusor Opal

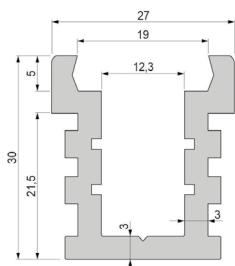

PERFIS PARA DEGRAUS

PERFIL SCALA



VARA 3m VARA 2m AL IK08

Potência máxima | Potencia máxima: 63W/mt
 Aplicação | Aplicación
 Pavimento | Piso
 Degraus | Escalones

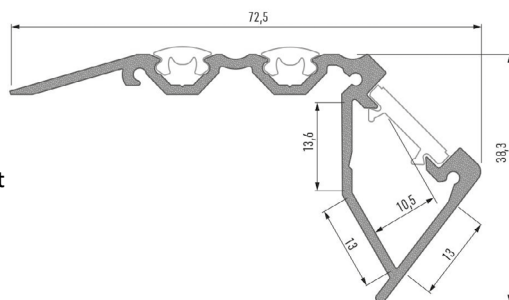

Ref.	Cor Color
PFA11241	Anodizado Anodizado
PFA11248	Anodizado Preto Anodizado Negro
PFA11241.3	Anodizado 3mt Anodizado 3mt

DIFUSOR

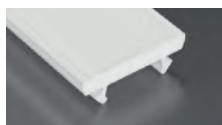

DF50 | DF50.3
 Difusor Opalino
 Difusor Opal

	TP11241D	Topo AL Cinza Dir. Tapa AL Gris Dcho.
	TP11241E	Topo AL Cinza Esq. Tapa AL Gris Izq.
	TP11248D	Topo AL Preto Dir. Tapa AL Negro Dcho.
	TP11248E	Topo AL Preto Esq. Tapa AL Negro Izq.
	228629.2	Anti-Derrapante PVC Anti-Derrapante PVC (unidade venda: 1un de 2mt)



PERFIL MATEUS



VARA 2m AL

Aplicação | Aplicación:
 Degraus de Escadas
 Pasos de Escaleras

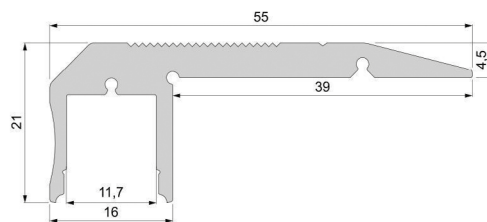

Ref.	Cor Color
PFD0523	Anodizado Anodizado

	TPD8201	Topo Cinza Esq. e Dir. (2 uni.) Tapa Gris Izq. y Dcho. (2 uni.)
--	---------	--

DIFUSOR



DFD3013	DFD3015
Difusor Semi-Opalino Difusor Semi-Opal	Difusor Opalino Difusor Opal

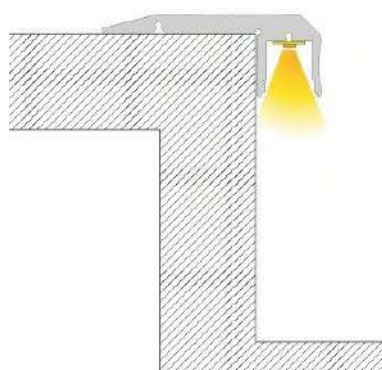

PERFIS PARA DEGRAUS

PERFIL MITO



VARA 2m IP54 AL NOVO NUEVO

Aplicação | Aplicación:
Degraus de Escadas
Pasos de Escaleras

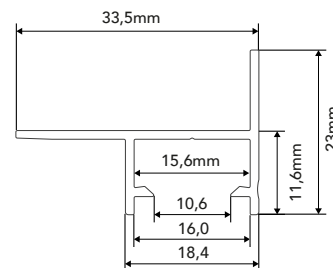

Modelo	Ref.	Cor Color	Ref.	Acessórios
MITO	PFA111351	Anodizado Anodizado	TPF201091	Topo PL Cinza Tapa PL Gris
	PFA111358	Lacado Preto Lacado Negro	TPF201098	Topo PL Preto Tapa PL Negro
			DF50*	Difusor Opalino "Milk" Difusor Opalino "Milk"

APLICAÇÃO | APLICACIÓN

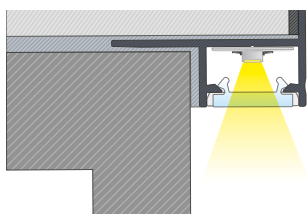

*Disponível em | Disponible en:

VARA 2m DF50 50m DF50.50

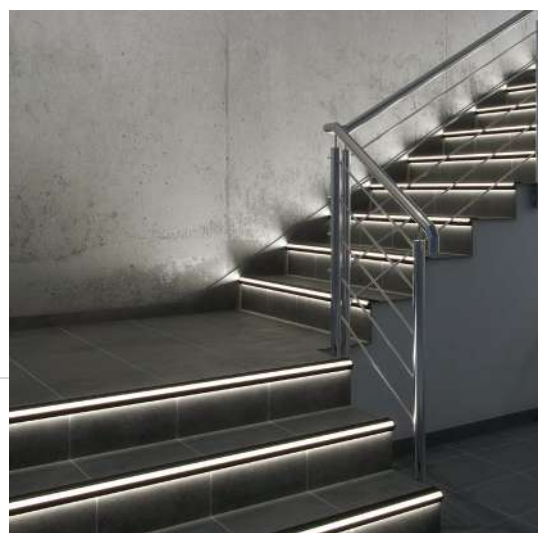

PERFIL EVORAMONTE



VARA 2m IP20 AL NOVO NUEVO

Aplicação | Aplicación:
Degraus de Escadas
Pasos de Escaleras

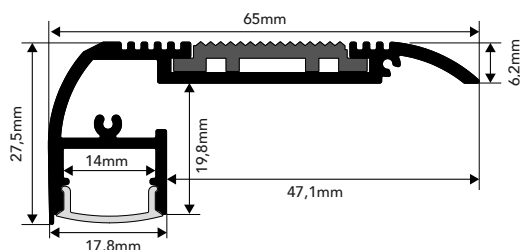

Modelo	Ref.	Cor Color	Ref.	Acessórios
EVORAMONTE	PFA111161	Anodizado c/ Difusor Semi-Opalino Anodizado c/ Difusor Semi-Opalino	TP111161	Kit 2 Topos Alumínio Cinza Kit 2 Topos Alumínio Gris
	PFA111168	Preto c/ Difusor Semi-Opalino Negro c/ Difusor Semi-Opalino	TP111168	Kit 2 Topos Alumínio Lacado Preto Kit 2 Topos Alumínio Lacado Negro

APLICAÇÃO | APLICACIÓN

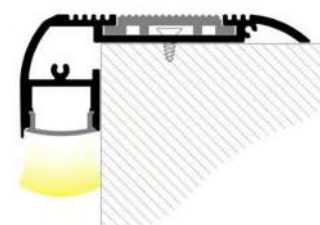



Os perfis de aplicação especial podem ser utilizados em roupeiros como um varão iluminado, construção de luminárias de parede tais como apliques de luz indireta, iluminação específica de móveis, entre outros.

Los perfiles de aplicación especial se pueden utilizar en armarios como barra luminosa, construcción de apliques como apliques de luz indirecta, iluminación específica para muebles, entre otros.

APLICAÇÃO ESPECIAL

Aplicación Especial

PERFIS APLICAÇÃO ESPECIAL

PERFIL MICO



Potência máxima | Potencia máxima: 19,6W/mt
 Aplicação | Aplicación: Saliente / Suspensão | Saliente / Suspensión

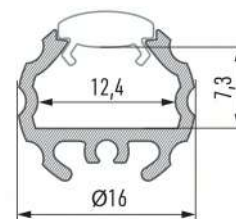

Ref.	Cor Color
PFA1301	Anodizado Anodizado
PFA1308	Anodizado Preto Anodizado Negro

	TP1301	Topo PL Cinza Tapa PL Gris
	TP1308	Topo PL Preto Tapa PL Negro
	FX30	Fixador Fijador

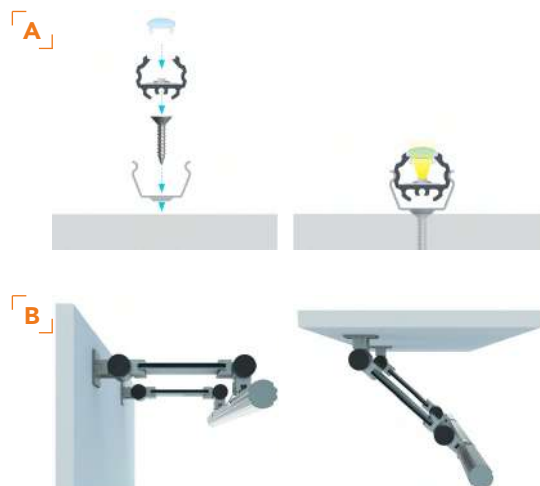

DIFUSORES

	DF6SO Difusor Semi-Opalino Difusor Semi-Opal
	DF6O Difusor Opalino Difusor Opal
	DF6PT Difusor Preto Difusor Negro

PERFIL FASSO



Aplicação | Aplicación: Saliente

Ref.	Cor Color
PFA11081	Anodizado Anodizado
PFA11081.3	Anodizado 3mt Anodizado 3mt

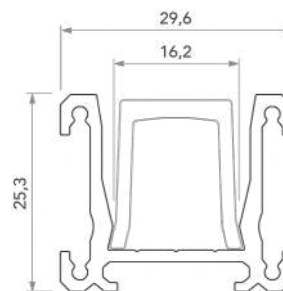

Ref.	
	DF7OSOLID Difusor Opalino
	DF7O.3SOLID Difusor Opalino 3mt
	FX11081 Fixador em Alumínio Fijador de aluminio
	TP11081 Topo AL Cinza Topo AL Gris
	TPF11081 Topo c/ Furo AL Cinza Topo c/ Orifício AL Gris
	TPS11081 Topo Sólido p/ Difusor

APLICAÇÃO | APLICACIÓN

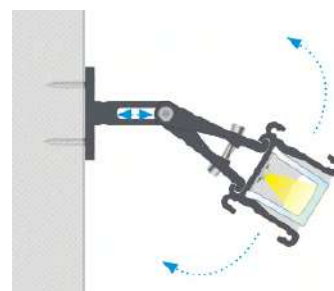

PERFIS APLICAÇÃO ESPECIAL

PERFIL COSMO

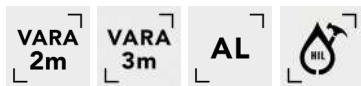

Potência máxima | Potencia máxima: 28W/mt
 Aplicação | Aplicación: Saliente / Suspensão | Saliente / Suspensión

Ideal para aplicação em roupeiros.
 Ideal para aplicación en armarios.

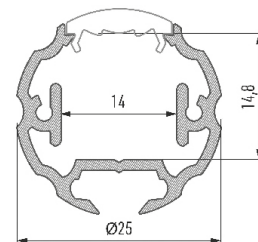

Ref.	Cor Color
PFA1231	Anodizado Anodizado
PFA1232	Lacado Branco Laca Blanco
PFA1238	Anodizado Preto Anodizado Negro
PFA1231.3	Anodizado 3mt Anodizado 3mt

	TP1231	Topo PL Cinza Tapa PL Gris
	TP1232	Topo PL Branco Tapa PL Blanco
	TP1238	Topo PL Preto Tapa PL Negro
	TP1231R	Topo AL Cinza c/ regulação Tapa AL Gris c/ regulación

Ref.	Cor Color	
	PM1231	Perfil montagem METRO Perfil montaje METRO
	228430	Afastador Alumínio Retractor de Aluminio
	FX123	Fixador Fijador
	SALF1231	Suporte afastador c/ furo Soporte retractor c/ agujero
	SAL1231	Suporte afastador s/ furo Soporte retractor s/ agujero
	228421	Fixador orientável Fijador orientable
	PAR123	Parafuso de fixação Tornillo de fijación
	BF1231	Base fixação Base de fijación
	BFX123	Peça base fixação Pieza base de fijación
	FXF123	Peça fixação fêmea Pieza de fijación hembra
	FXM123	Peça fixação macho Pieza de fijación macho

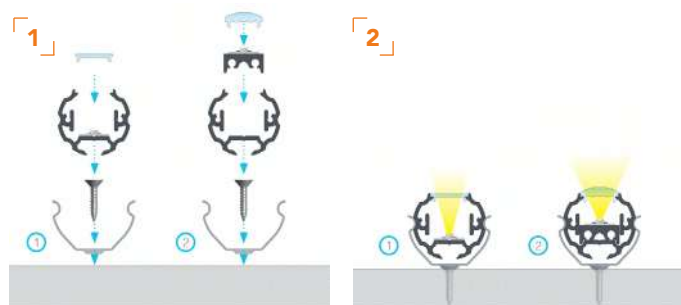

Perfil Cosmo é um perfil redondo / ajustável para o interior do roupeiro. Ideal para a iluminação local e decorativa.

El perfil Cosmo es un perfil redondo/ajustable para el interior del armario. Ideal para iluminación local y decorativa.

DIFUSORES

DF1LT DF1LT30	DF1T	DF1SOE*	DF1F	DF1OE*	DF1PT DF1PT.3
Difusor Lente 15° Difusor Lente 30°	Difusor Transparente	Difusor Semi-Opal Difusor Semi-Opal	Difusor Fosco Difusor Mate	Difusor Opalino Difusor Opal	Difusor Preto Difusor Negro

*Disponível em: *Disponible en:

DF1SOE.3 DF1OE.3	DF1SOE.10 DF1OE.10	DF1SOE.20 DF1OE.20	DF1SOE.30 DF1OE.30	DF1SOE.40 DF1OE.40	DF1SOE.50 DF1OE.50

PERFIS APLICAÇÃO ESPECIAL

PERFIL Q18*



VARA
2m

AL

Potência máxima | Potencia máxima: 24W/mt

Aplicação | Aplicación:

Saliente de canto | Saliente de Esquina

* Disponível em mais medidas

* Disponible en más tallas

Ref.	Cor Color
PFA17431	<input checked="" type="checkbox"/> Anodizado <input type="checkbox"/> Anodizado
PFA17432	<input type="checkbox"/> Lacado Branco <input type="checkbox"/> Laca Blanco
PFA17438	<input checked="" type="checkbox"/> Anodizado Preto <input type="checkbox"/> Anodizado Negro

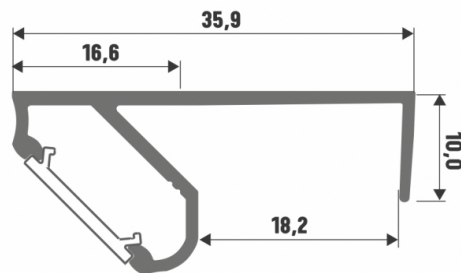

Perfil angular de 45°, para aplicar iluminação em armários, prateleiras e bancadas.

Perfil en ángulo de 45°, para aplicar iluminación en armarios, estanterías y encimeras.

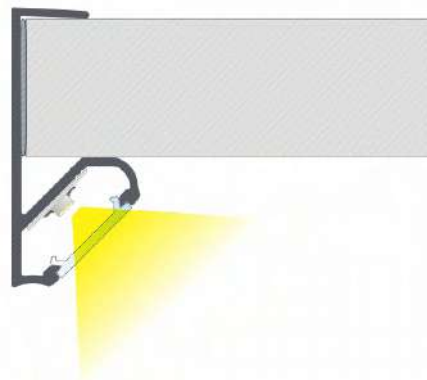

DIFUSORES



DF1LT | DF1LT30

Difusor Lente 15°

Difusor Lente 30°

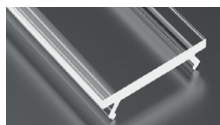

DF1T

Difusor

Transparente



DF1SOE*

Difusor

Semi-Opalino

Difusor Semi-Opal

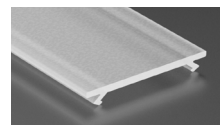

DF1F

Difusor Fosco

Difusor Mate

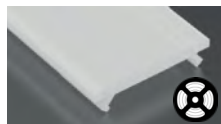

DF1OE*

Difusor Opalino

Difusor Opal

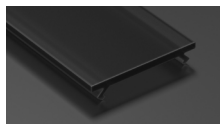

DF1PT | DF1PT.3

Difusor Preto

Difusor Negro



*Disponível em:

*Disponible en:



DF1SOE.3 DF1SOE.10 DF1SOE.20 DF1SOE.30 DF1SOE.40 DF1SOE.50
DF1OE.3 DF1OE.10 DF1OE.20 DF1OE.30 DF1OE.40 DF1OE.50

PERFIS APLICAÇÃO ESPECIAL

PERFIL RETO



Potência máxima | Potencia máxima: 33,6/mt
 Aplicação | Aplicación: Saliente

Ref.	Cor Color
PFA1241	Anodizado Anodizado
PFA1242	Lacado Branco Laca Blanco
PFA1248	Anodizado Preto Anodizado Negro
PFA1241.3	Anodizado 3mt Anodizado 3mt

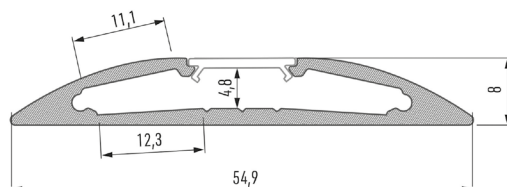

	TP1241	Topo PL Cinza Tapa PL Gris
	TP1242	Topo PL Branco Tapa PL Blanco

É um perfil de superfície com a possibilidade de iluminação em várias posições - Luz direta ou indireta. Idealmente usado em cozinhas, prateleiras e estantes.

Es un perfil de superficie con posibilidad de iluminación en varias posiciones - luz directa o indirecta. Idealmente utilizado en cocinas, estanterías y librerías.

DIFUSORES

DF1LT DF1LT30 Difusor Lente 15° Difusor Lente 30°	DF1T Difusor Transparente	DF1SOE* Difusor Semi-Opalino Difusor Semi-Opal	DF1F Difusor Fosco Difusor Mate
DF1OE* Difusor Opalino Difusor Opal	DF1PT DF1PT.3 Difusor Preto Difusor Negro		



*Disponível em:
*Disponible en:



DF1SOE.3 DF1SOE.10 DF1SOE.20 DF1SOE.30 DF1SOE.40 DF1SOE.50
 DF1OE.3 DF1OE.10 DF1OE.20 DF1OE.30 DF1OE.40 DF1OE.50



PERFIS APLICAÇÃO ESPECIAL

PERFIL UNICO



Perfil Urai



Potência máxima | Potencia máxima: 56W/mt
 Aplicação | Aplicación: Saliente

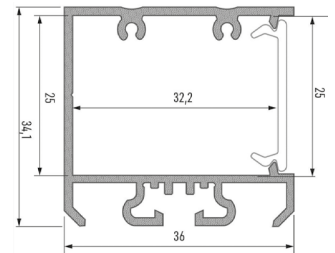

Ref.	Cor Color
PFA1114	Anodizado Anodizado
PFA11142	Lacado Branco Laca Blanco

	PFS1140	Perfil Fixador Anodizado Perfil Fijador Anodizado
	PFS11402	Perfil Fixador Tália M2 Anodizado Perfil Fijador Tália M2 Anodizado

Ref.	Cor Color
TPD1141	Topo AL Cinza Dir. Tapa AL Gris Dcho.
TPE1141	Topo AL Cinza Esq. Tapa AL Gris Izq.
TPD1142	Topo AL Branco Dir. Tapa AL Blanco Dcho.
TPE1142	Topo AL Branco Esq. Tapa AL Blanco Izq.
TPD11412*	Topo AL Dir. p/Urai+Tália M2 Tapa AL Dcho. p/ Urai+Tália M2
TPE11412	Topo AL Esq. p/Urai+Tália M2 Tapa AL Izq. p/ Urai+Tália M2

*Utilizar quando a calha é usada com perfil fixado.

Perfil saliente unilateral, ideal para aplicação na parede com projeção de luz na vertical. Exemplo: Aplique de parede personalizável com RGB.

Perfil voladizo a una cara, ideal para aplicación en pared con proyección de luz vertical. Ejemplo: Aplique de pared personalizable con RGB.

ACESSÓRIOS DISPONÍVEIS | ACCESORIOS DISPONIBLES

Unões de ligação | Uniones

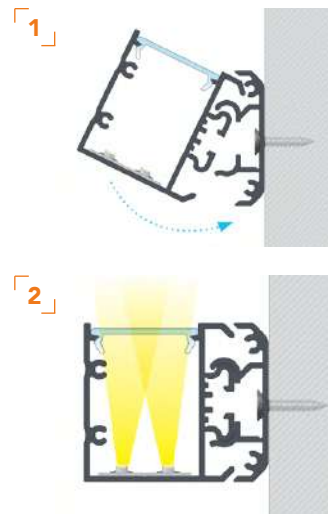

DIFUSORES

DF3T	DF3SOE*	DF3OE*	DF3PT	DF3PTE*
Difusor Transparente	Difusor Semi-Opalino Difusor Semi-Opal	Difusor Opalino Difusor Opal	Difusor Preto Difusor Negro	Preto Mate Negro mate



*Disponível em:
*Disponible en:

DF3PTE	DF3SOE.3 DF3OE.3	DF3SOE.10 DF3OE.10 DF3PTE.10	DF3SOE.20 DF3OE.20	DF3SOE.30 DF3OE.30	DF3SOE.40 DF3OE.40	DF3SOE.50 DF3OE.50 DF3PTE.50

PERFIS APLICAÇÃO ESPECIAL

PERFIL DOPIO



Potência máxima
Potencia máxima: 67,2W/mt
Aplicação | Aplicación: Saliente

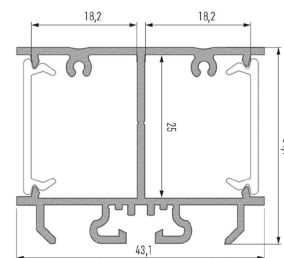

Ref.	Cor Color		TP1281	■ Topo AL Cinza Tapa AL Gris
PFA1281	■ Anodizado Anodizado		TP12812	■ Topo AL Cinza p/ Dopio + Tália M2 Tapa AL Gris p/ Dopio + Tália M2

	PFS1140	■ Perfil Fixador Anodizado Perfil Fijador Anodizado
	PFS11402	■ Perfil Fixador Tália M2 Anodizado Perfil Fijador Tália M2 Anodizado

Este é um perfil saliente com iluminação bilateral. Após aplicação na parede projeta luz para cima e para baixo.

Se trata de un perfil elevado con iluminación bilateral. Tras su aplicación en la pared, proyecta luz hacia arriba y hacia abajo.

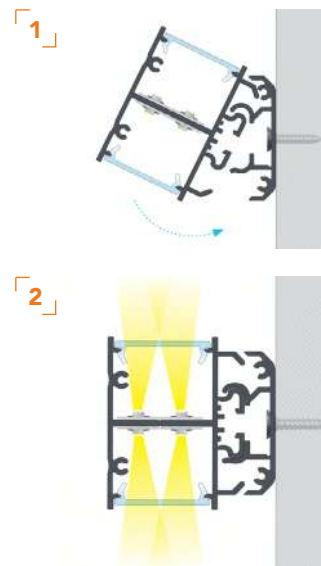

ACESSÓRIOS DISPONÍVEIS | ACCESORIOS DISPONIBLES

Uniões de ligação | Uniones



DIFUSORES

DF3T Difusor Transparente	DF3SOE* Difusor Semi-Opalino Difusor Semi-Opal	DF3OE* Difusor Opalino Difusor Opal	DF3PT DF3PT.3 3MT Difusor Preto Difusor Negro	DF3PTE* Preto Mate Negro mate



*Disponível em:
*Disponible en:

DF3PTE	DF3SOE.3 DF3OE.3	DF3SOE.10 DF3OE.10 DF3PTE.10	DF3SOE.20 DF3OE.20	DF3SOE.30 DF3OE.30	DF3SOE.40 DF3OE.40	DF3SOE.50 DF3OE.50 DF3PTE.50

PERFIS APLICAÇÃO ESPECIAL

PERFIL TIPO E



VARA 2m AL

Aplicação | Aplicación:
Saliente

Ref.	Cor Color
PFA6371	Anodizado Anodizado

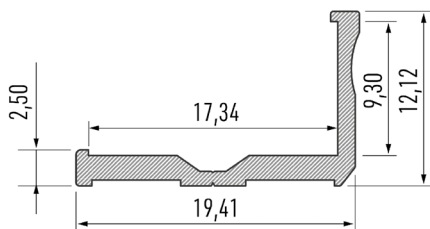

PERFIL TIPO F



VARA 2m AL

Aplicação | Aplicación:
Saliente

Ref.	Cor Color
PFA6391	Anodizado Anodizado
PFA6397	Não Anodizado No Anodizado

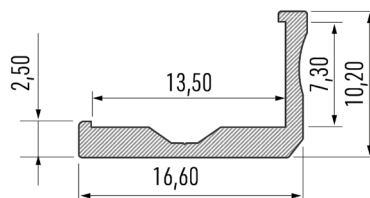

Os perfis E e F são perfis montados na superfície para iluminar salas de estar e residências. Perfeitos para iluminação de nichos e prateleiras. São um produto com estrutura atípica, minimalista e com alta qualidade de execução.

Los perfiles E y F son perfiles de superficie para la iluminación de salones y viviendas. Perfecta para iluminar nichos y estanterías. Son un producto con una estructura atípica, minimalista y con una gran calidad de ejecución.



PERFIL ALEGRETE



VARA 2m AL

Aplicação | Aplicación:
Encastrar | Empotrar

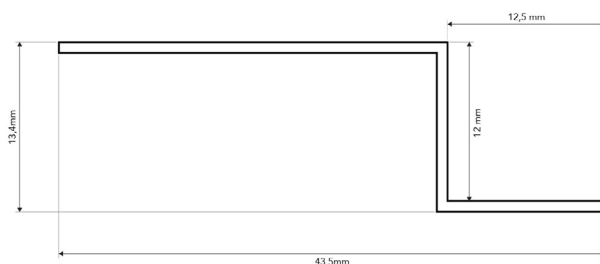

Ref.	Cor Color
PFG02090	Lacado Branco Laca Blanco
PFG02091	Anodizado Preto Anodizado Negro

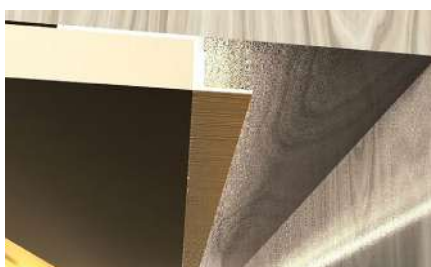

PERFIS APLICAÇÃO ESPECIAL

PERFIL LOGI



VARA
2m
AL

Potência máxima Potencia máxima: 63W/mt
Aplicação | Aplicación: Saliente / Sanca

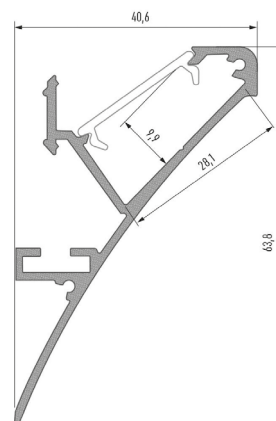

Ref.	Cor Color
PFA14321	Anodizado Anodizado
PFA14322	Lacado Branco Laca Blanco



TP14321D	Topo AL Cinza Dir. Tapa AL Gris Dcho.
TP14321E	Topo AL Cinza Esq. Tapa AL Gris Izq.
TP14322D	Topo AL Branco Dir. Tapa AL Blanco Dcho.
TP14322E	Topo AL Branco Esq. Tapa AL Blanco Izq.

PERFIL CONVA



VARA
2m
AL

Potência máxima Potencia máxima: 64,4W/mt
Aplicação | Aplicación: Saliente / Sanca

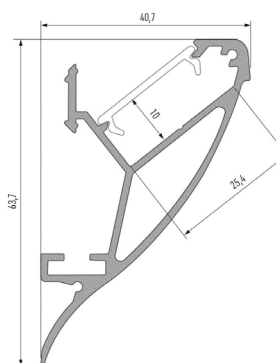

Ref.	Cor Color
PFA14331	Anodizado Anodizado
PFA14332	Lacado Branco Laca Blanco



TP14331D	Topo AL Cinza Dir. Tapa AL Gris Dcho.
TP14331E	Topo AL Cinza Esq. Tapa AL Gris Izq.
TP14332D	Topo AL Branco Dir. Tapa AL Blanco Dcho.
TP14332E	Topo AL Branco Esq. Tapa AL Blanco Izq.

Os perfis Logi e Conva são perfis ideais para realizar uma sanca. Necessita do perfil de montagem para fixação.
Los perfiles Logi y Conva son perfiles ideales para conseguir luz indirecta. Requiere perfil de montaje para la fijación.

ACESSÓRIOS DISPONÍVEIS | ACCESORIOS DISPONIBLES

Unões de ligação | Uniones

Perfil de montagem
Perfil de montaje



DIFUSORES CIMA | DIFUSORES ARRIBA

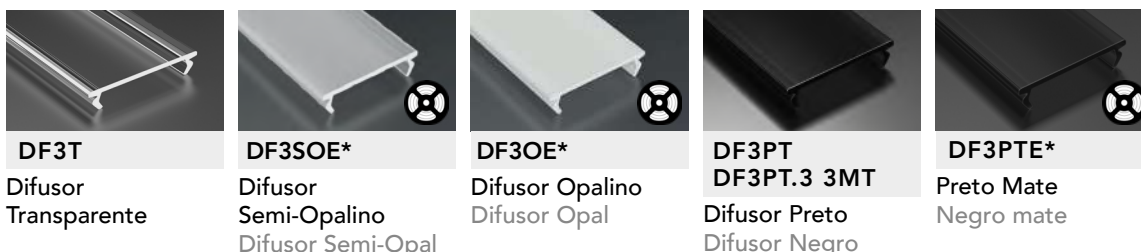

*Disponível em:
*Disponible en:

VARA 2m	VARA 3m	10m	20m	30m	40m	50m
DF3PTE	DF3SOE.3 DF3OE.3	DF3SOE.10 DF3OE.10 DF3PTE.10	DF3SOE.20 DF3OE.20	DF3SOE.30 DF3OE.30	DF3SOE.40 DF3OE.40	DF3SOE.50 DF3OE.50 DF3PTE.50

PERFIS APLICAÇÃO ESPECIAL

PERFIL NEIVA



VARA 2m IP20 AL

Aplicação | Aplicación:
Saliente

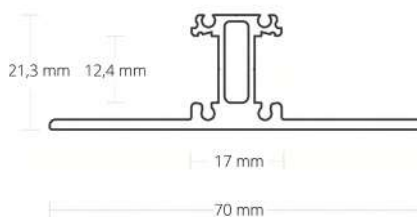

Ref.	Cor Color
PFG01004	Anodizado Anodizado
PFG01003	Anodizado Branco Anodizado Blanco
PFG01002	Anodizado Preto Anodizado Negro

APLICAÇÕES DISPONÍVEIS
APLICACIONES DISPONIBLES



	TPG01005	Topo PL Cinza Tapa PL Gris
	TPG01006	Topo PL Branco Tapa PL Blanco
	TPG01007	Topo PL Preto Tapa PL Negro
	DFG00004	Difusor Semi-Opalino Difusor Semi-Opal
	DFG00154	Difusor Opalino Difusor Opal
	DFG00070	Difusor Preto Difusor Negro
	PFG01080	Perfil de Montagem 2mt Perfil de Montaje 2mt

PERFIL MONFORTE



VARA 2m IP20 AL

Aplicação | Aplicación:
Saliente Flexível
Saliente Flexible

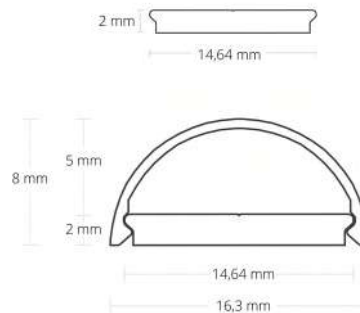

Ref.	Cor Color
PFG05050	Anodizado Anodizado

	TPG01045	Topo Silicone Cinza Tapa AL Gris
	DFG00045	Difusor Semi-Opalino Difusor Semi-Opal



PERFIS APLICAÇÃO ESPECIAL

PERFIL BRAGANÇA

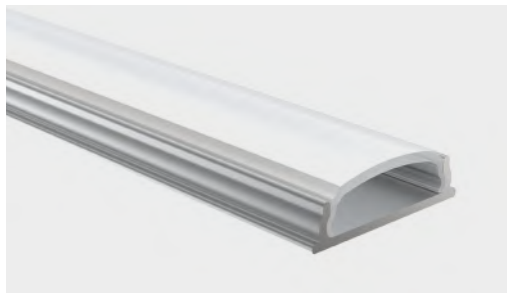

VARA 2m | IP20 | AL | NOVO NUEVO

Aplicação | Aplicación: Saliente

Perfil flexível de alumínio, concebido para fitas led flexíveis com 8 a 12 mm de largura.

Perfil flexible de aluminio, diseñado para tiras LED flexibles de 8 a 12 mm de ancho.

Modelo	Ref.	Cor Color
BRAGANÇA	PFA181171	Anodizado c/ Difusor Semi-Opalino Anodizado c/ Difusor Semi-Opalino
	TP181171	Topo Plástico Cinza Topo Plástico Gris
	TPF181171	Topo Plástico c/ Furo Cinza Topo Plástico c/ Orificio Gris
	FX181171	Fixador de metal Fijador de metal

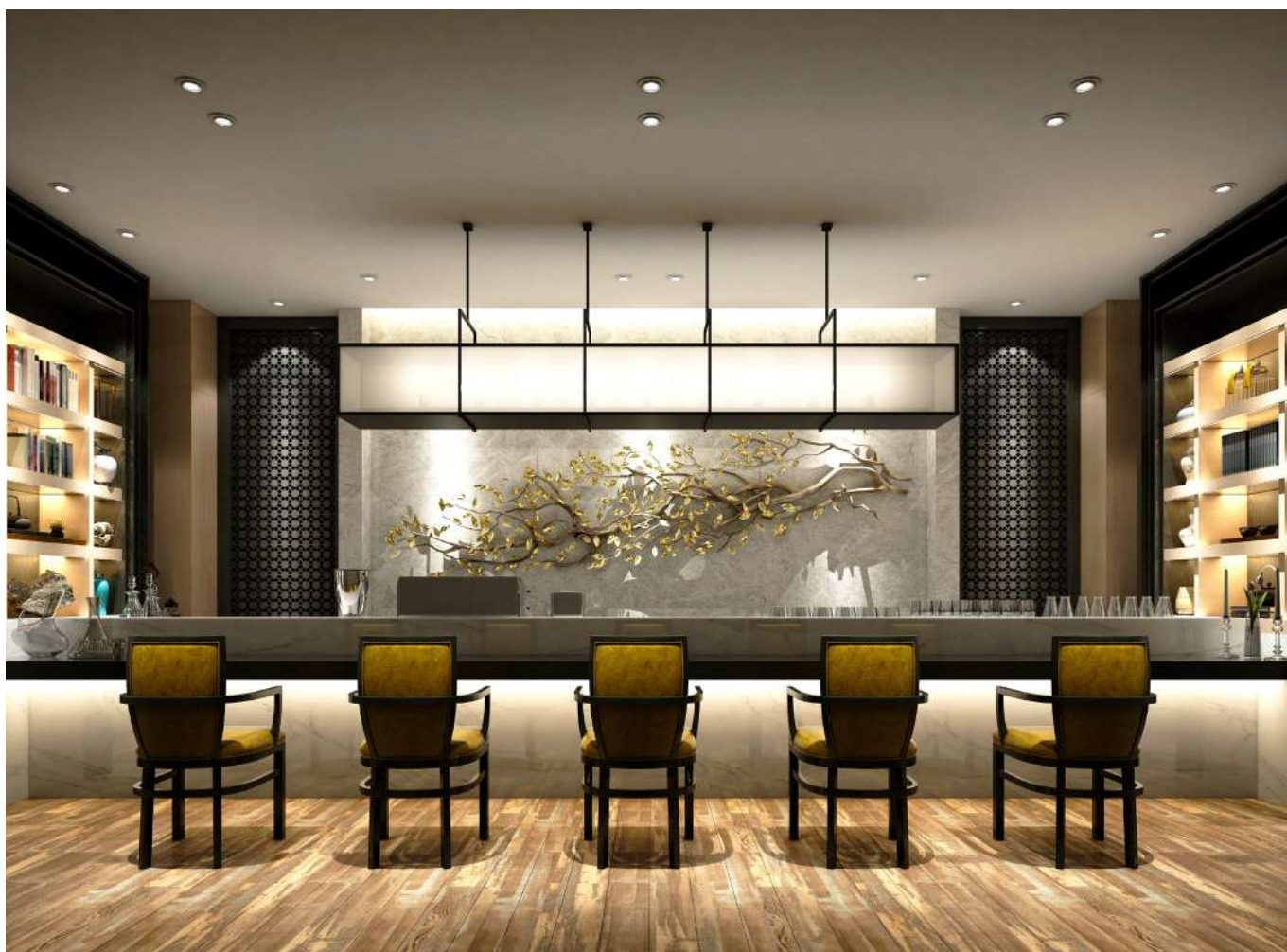
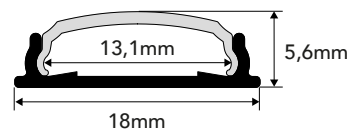

PERFIS APLICAÇÃO ESPECIAL

PERFIL FONTALVA

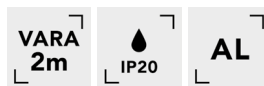

Aplicação | Aplicación:
Encastre | Empotrar

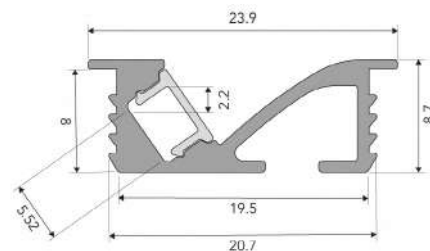

Ref.	Cor Color
PFG23168	Anodizado Anodizado
PFG23170	Anodizado Branco Anodizado Blanco
PFG23169	Anodizado Preto Anodizado Negro

	TPG23197	Topo AL Cinza Tapa AL Gris
	TPG23199	Topo AL Branco Tapa AL Blanco
	TPG23198	Topo AL Preto Tapa AL Negro

	FXG23202	Fixador Fijador
	DFG00106	Difusor Semi-Opalino Difusor Semi-Opal

PERFIL MONDEGO



Aplicação | Aplicación: Encastre | Empotrado

Perfil de encastre fino para prateleira horizontal e difusor angular. Idealizado para fitas com 5 mm de largura.

Perfil fino empotrado para estante horizontal y difusor angular. Diseñado para cintas de 5 mm de ancho.

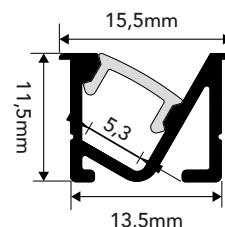

Modelo	Ref.	Cor Color
MONDEGO	PFA21131	Anodizado c/ Difusor Semi-Opalino Anodizado c/ Difusor Semi-Opalino

Ref.	Acessórios
TP21131	Topo Plástico Cinza Topo Plástico Gris

APLICAÇÃO | APLICACIÓN

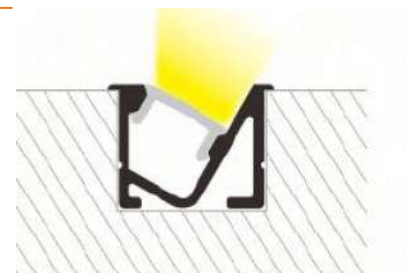

PERFIS APLICAÇÃO ESPECIAL

PERFIL VALENÇA

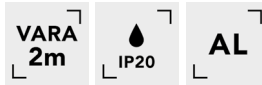

Aplicação | Aplicación:
Saliente

Ref.	Cor Color
PFG23171	Anodizado Anodizado
PFG23173	Anodizado Branco Anodizado Blanco
PFG23172	Anodizado Preto Anodizado Negro

	TPG23197	Topo AL Cinza Tapa AL Gris
	TPG23199	Topo AL Branco Tapa AL Blanco
	TPG23198	Topo AL Preto Tapa AL Negro

	FXG23202	Fixador Fijador
	DFG00106	Difusor Semi-Opalino Difusor Semi-Opal

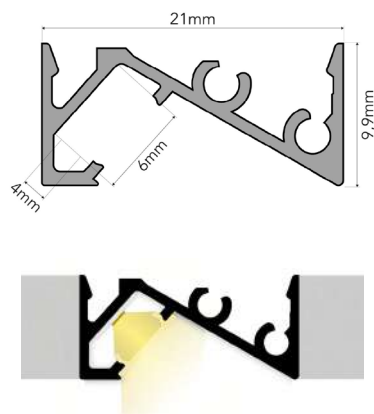



PERFIS DE RODAPÉ E RODATETO

Perfiles de Rodapié y Zócalo

PERFIS DE RODAPÉ / RODATETO

PERFIL ALTER DO CHÃO



VARA 2m IP20 AL NOVO NUEVO

Aplicação | Aplicación:
Rodapé de Encastre | Rodapié Empotrado
Perfil de encastre em alumínio para parede em gesso cartonado.
Perfil empotrado en aluminio para pared de cartón yeso.

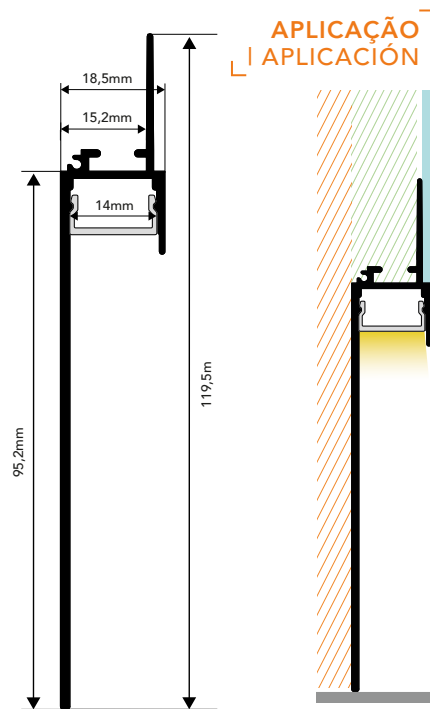

Modelo	Ref.	Cor Color
ALTER DO CHÃO	PFA81211	Anodizado c/ Difusor Semi-Opalino Anodizado c/ Difusor Semi-Opalino
	PFA81212	Branco c/ Difusor Semi-Opalino Blanco c/ Difusor Semi-Opalino

Ref.	Acessórios
TP81212	Topo Alumínio Branco Topo Alumínio Blanco
TPF81212	Topo Alumínio c/ Furo Branco Topo Alumínio c/ Orificio Blanco

Ref.	Acessórios
TP81211	Topo Alumínio Cinza Topo Alumínio Gris
TPF81211	Topo Alumínio c/ Furo Cinza Topo Alumínio c/ Orificio Gris

PERFIL PADERNE



VARA 2m IP20 AL NOVO NUEVO

Aplicação | Aplicación:
Rodapé de Encastre | Rodapié Empotrado
Perfil de alumínio estreito para encastrar.
Perfil de aluminio estrecho para empotrar.

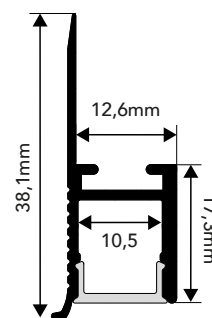

Modelo	Ref.	Descrição
PADERNE	PFA81111	Anodizado c/ Difusor Semi-Opalino Anodizado c/ Difusor Semi-Opalino
	PFA81112	Branco c/ Difusor Semi-Opalino Blanco c/ Difusor Semi-Opalino

Ref.	Acessórios
TP81111	Topo Plástico Cinza Topo Plástico Gris



PERFIS DE RODAPÉ / RODATETO

PERFIL SILVES



VARA 2m IP20 AL NOVO NUEVO

Aplicação | Aplicación: Rodapé | Rodapié

Perfil de alumínio projetado para um máximo de duas fitas led flexíveis ou rígidas com 10 mm de largura.

Perfil de aluminio diseñado para un máximo de dos cintas led flexibles o rígidas de 10 mm de ancho.

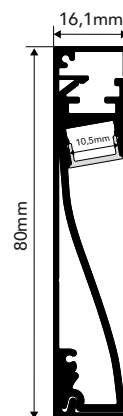

Modelo	Ref.	Cor Color		Ref.	Acessórios
SILVES	PFA131241	Anodizado c/ Difusor Semi-Opalino Anodizado c/ Difusor Semi-Opalino		TP131241	Topo Plástico Topo Plástico
	PFT131241	Anodizado c/ Difusor Transparente Anodizado c/ Difusor Transparente		CI131241	Conector de Esquina Interior Conector de Esquina Interior
				CE131241	Conector de Esquina Exterior Conector de Esquina Exterior

PERFIL ALFEIZERÃO



VARA 2m IP20 AL NOVO NUEVO

Aplicação | Aplicación: Rodapé | Rodapié

Perfil de encaixe em alumínio para rodapé, inclui perfil de montagem.

Perfil de aluminio para empotrar en rodapiés, incluye perfil de montaje.

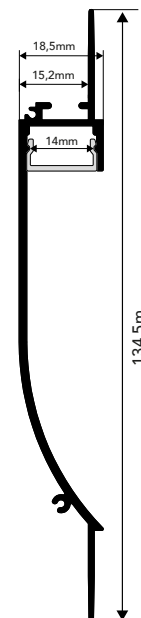

Modelo	Ref.	Cor Color
ALFEIZERÃO	PFA131231	Anodizado c/ Difusor Semi-Opalino Anodizado c/ Difusor Semi-Opalino

APLICAÇÃO | APLICACIÓN

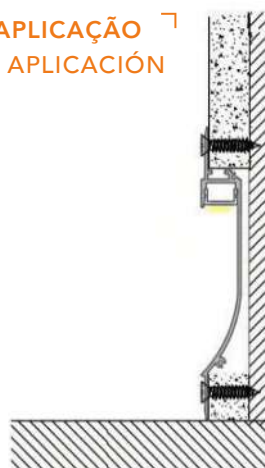

Perfil de Montagem incluído
Perfil de Montaje incluido

PERFIS DE RODAPÉ / RODATETO

PERFIL LINHARES

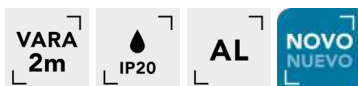
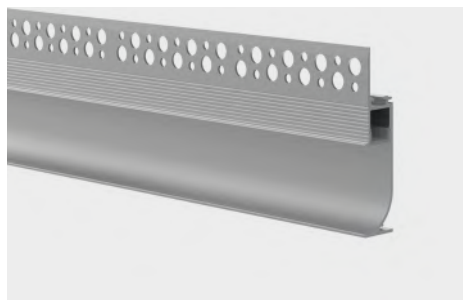

Aplicação | Aplicación:
Rodapé de Encastre | Rodapié Empotrado

Perfil de aplicação encastrada com barramento tornando aba invisível. Ideal para rodapé e de iluminação indireta.
Perfil de aplicación empotrado con busbar que hace invisible la pestaña. Ideal para zócalos y iluminación indirecta.

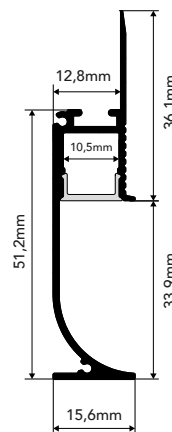

Modelo	Ref.	Cor Color	Ref.	Acessórios
LINHARES	PFA81121	Anodizado c/ Difusor Semi-Opalino Anodizado c/ Difusor Semi-Opalino	TP81121	Topo Plástico Cinza Topo Plástico Gris
	PFA81122	Branco c/ Difusor Semi-Opalino Blanco c/ Difusor Semi-Opalino	TPF81121	Topo Plástico c/ Furo Cinza Topo Plástico c/ Orifício Gris

PERFIL LEIRIA

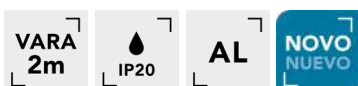
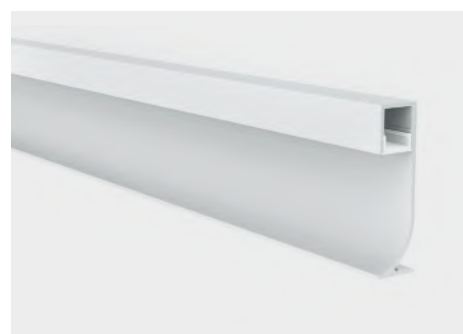

Aplicação | Aplicación:
Rodapé Saliente | Rodapié Saliente

Perfil alumínio para rodapé para iluminação indireta. Este perfil pode ser aplicado com um perfil de montagem.

Perfil de aluminio para zócalo para iluminación indirecta. Este perfil se puede aplicar con un perfil de montaje.

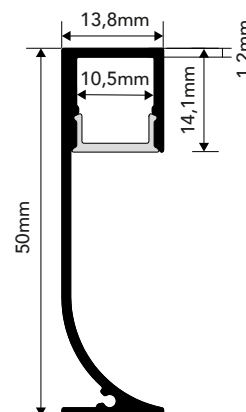

Modelo	Ref.	Cor Color	Ref.	Acessórios
LEIRIA	PFA131262	Branco c/ Difusor Semi-Opalino Blanco c/ Difusor Semi-Opalino	TP131262	Topo Plástico Branco Topo Plástico Blanco

PERFIL MARIALVA

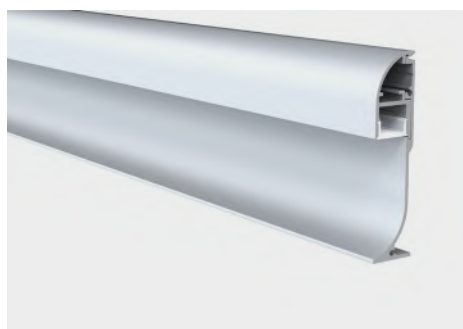

Aplicação | Aplicación:
Rodapé Saliente | Rodapié Saliente

Perfil de alumínio para aplicação saliente de rodapé. Este sistema de perfil permite a passagem de cabos oculta.

Perfil de aluminio para aplicación saliente de rodapié. Este sistema de perfil permite el paso oculto de cables.

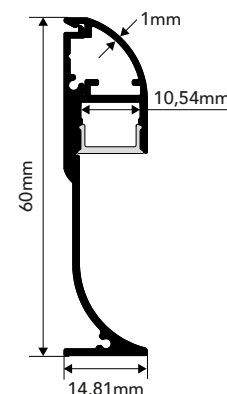

Modelo	Ref.	Cor Color	Ref.	Acessórios
MARIALVA	PFA131321	Anodizado c/ Difusor Semi-Opalino Anodizado c/ Difusor Semi-Opalino	TP131321	Topo Plástico Cinza Topo Plástico Gris

PERFIS DE RODAPÉ / RODATETO

PERFIL TIANO



VARA
2m

AL

CORTE
52,3mm

Potência máxima: 52,5W/mt
 Potencia máxima: 52,5W/mt
 Aplicação: Gesso / Rodapé
 Aplicación: Yeso / Rodapié

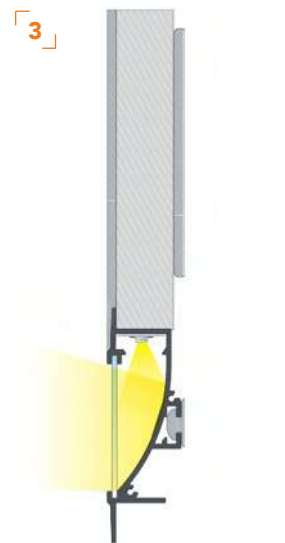
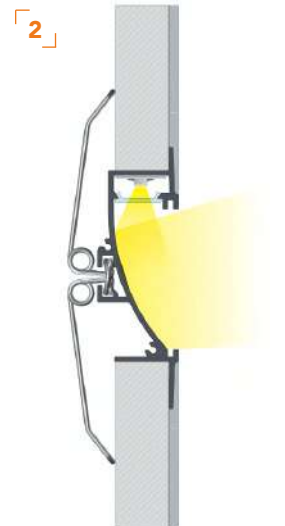
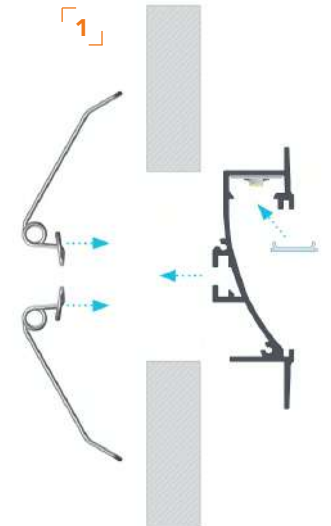
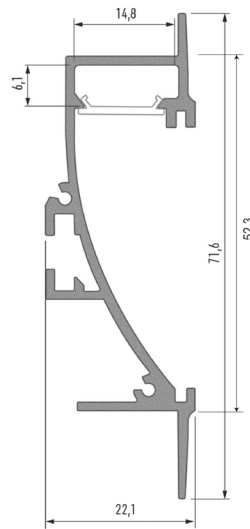

Ref.	Cor Color
PFA13281	<input checked="" type="checkbox"/> Anodizado <input type="checkbox"/> Anodizado
PFA13282	<input type="checkbox"/> Lacado Branco <input checked="" type="checkbox"/> Laca Blanco

	<input checked="" type="checkbox"/> TP281D Topo AL Cinza Dir. Tapa AL Gris Dcho.
	<input checked="" type="checkbox"/> TP281E Topo AL Cinza Esq. Tapa AL Gris Izq.
	<input type="checkbox"/> TP282D Topo AL Branco Dir. Tapa AL Blanco Dcho.
	<input type="checkbox"/> TP282E Topo AL Branco Esq. Tapa AL Blanco Izq.

ACESSÓRIOS DISPONÍVEIS | ACCESORIOS DISPONIBLES

Difusor grande

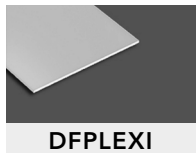

Unões de ligação | Uniones



DIFUSORES

			
DF1T Difusor Transparente	DF1SOE* Difusor Semi-Opal Difusor Semi-Opal	DF1F Difusor Fosco Difusor Mate	DF1OE* Difusor Opalino Difusor Opal



*Disponível em:
*Disponible en:



DF1SOE.3 DF1SOE.10 DF1SOE.20 DF1SOE.30 DF1SOE.40 DF1SOE.50
 DF1OE.3 DF1OE.10 DF1OE.20 DF1OE.30 DF1OE.40 DF1OE.50

PERFIS DE RODAPÉ / RODATETO

PERFIL FLARO



VARA 2m AL CORTE 65,3mm

Potência máxima: 52,5W/mt | Potencia máxima: 52,5W/mt
 Aplicação: Gesso / Rodapé | Aplicación: Yeso / Rodapié

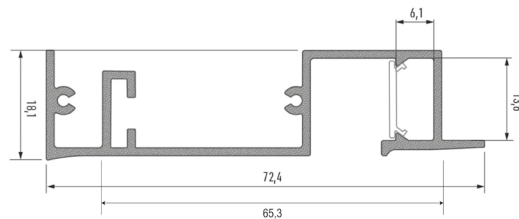

Ref.	Cor Color
PFA13271	Anodizado Anodizado
PFA13272	Lacado Branco Laca Blanco

	TP271D	Topo AL Cinza Dir. Tapa AL Gris Dcho.
	TP271E	Topo AL Cinza Esq. Tapa AL Gris Izq.
	TP272D	Topo AL Branco Dir. Tapa AL Blanco Dcho.
	TP272E	Topo AL Branco Esq. Tapa AL Blanco Izq.

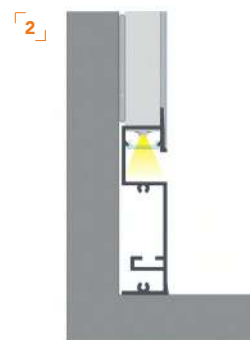

ACESSÓRIOS DISPONÍVEIS | ACCESORIOS DISPONIBLES

Unões de ligação | Uniones



Molas para perfil Clip metálico

228521U

228521UA

228521UT

228521UA120

228522

DIFUSORES



DF1T
Difusor Transparente



DF1SOE*
Difusor Semi-Opal
Difusor Semi-Opal

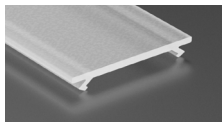

DF1F
Difusor Fosco
Difusor Mate

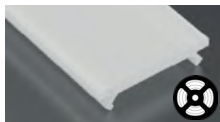

DF1OE*
Difusor Opalino
Difusor Opal



*Disponível em:
*Disponible en:



DF1SOE.3 DF1SOE.10 DF1SOE.20 DF1SOE.30 DF1SOE.40 DF1SOE.50

DF1OE.3 DF1OE.10 DF1OE.20 DF1OE.30 DF1OE.40 DF1OE.50

PERFIL SESIMBRA



VARA 2m IP20 AL NOVO NUEVO

Aplicação | Aplicación:
Rodapé Saliente | Rodapié Saliente

Inclui 2 peças para simplificar a montagem. Este sistema de perfil permite a passagem de cabos oculta. Incluye 2 piezas para simplificar el montaje. Este sistema de perfil permite el paso oculto de cables.

Modelo	Ref.	Cor Color
SESIMBRA	PFA131331	Anodizado c/ Difusor Semi-Opalino Anodizado c/ Difusor Semi-Opalino

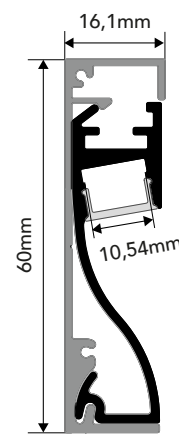



A photograph of an interior space featuring a wall of vertical wooden slats. The slats are illuminated from behind, creating a warm, golden glow. In the foreground, there is a dark, curved table. To the right, a tall green plant and a vase of purple flowers are visible. The overall atmosphere is modern and serene.

ÍNDICE DE REFERÊNCIAS

Índice de Referencias

ÍNDICE DE REFERÊNCIAS

ÍNDICE DE REFERENCIA

Referência	Pág.	Referência	Pág.	Referência	Pág.	Referência	Pág.
21217	287	20122444	268	20151370	325	130111.0960	152
21218	287	20122596	295	20151400	315	130115.0427	142
45218	287	20122604	295	20151401	313	130115.0430	142
213126	364	20122635	295	20151403	317	130115.0440	142
216226	354	20122740	268	20151409	320	130115.0460	142
221111	261	20122742	268	20151413	321	130121.0930	152
221112	261	20122794	295	20151414	315	130121.0940	152
221122	261	20122799	295	20180426	329	130121.0960	152
221133	261	20122815	295	2133275.33000	382	1301341.0727	148
221211	261	20123680	323	05.01005	61	1301341.0730	148
221212	261	20125400	315	05.01006	61	1301341.0740	148
221222	261	20125403	317	05.01007	61	1301341.0760	148
221233	261	20125502	316	05.01008	61	1301341.1227	179
221311	261	20125506	320	05.01101	61	1301341.1230	179
221312	261	20127031	306	05.01102	61	1301341.1240	179
221322	261	20127033	306	05.01103	61	1301341.1260	179
221333	261	20127037	306	05.01104	61	130141.0427	142
221411	261	20127041	306	05.01105	61	130141.0430	142
221412	261	20127042	306	06.03001	53	130141.0440	142
221422	261	20127047	306	06.03002	53	130141.0460	142
221433	261	20127080	323	06.03008	58	130145.0427	142
222217	41	20127081	323	06.03009	59	130145.0430	142
222241	41	20127082	323	06.03010	58	130145.0440	142
212217.4480W	334	20127087	324	06.03011	58	130145.0460	142
212217.1180	334	20127091	324	06.04001	54	13015.0730	149
223168	384	20127102	307	06.04002	57	13015.0740	149
228421	412	20127172	301	06.04003	57	13015.0760	149
228421	413	20127342	313	06.04004	56	13015.1227	180
228421	415	20127344	313	06.05001	54	13015.1230	180
228421	419	20127390	306	06.05002	59	13015.1240	180
228421	421	20127392	306	06.05003	59	13015.1260	180
228421	425	20127394	306	06.06003	54	13015.14RGB	193
228421	426	20127411	316	06.06004	60	130151.07RGB	146
228421	491	20127413	321	06.06005	60	130157.07RGB	146
228430	491	20127447	306	07.05003	56	13017.1230	181
228521	419	20127524	299	07.05009	56	13017.1240	181
228521	481	20127526	300	13011.0727	148	13017.1260	181
228522	436	20127527	299	13011.0730	148	13017.14RGB	193
228657	441	20127557	307	13011.0740	148	13041.0727	148
752184	287	20127568	301	13011.0760	148	13041.0730	148
2112226	354	20127576	321	13011.1227	179	13041.0740	148
2118237	359	20127613	325	13011.1230	179	13041.0760	148
2131231	363	20127678	302	13011.1240	179	13041.09VM	193
2131272	364	20127690	297	13011.1260	179	13041.1227	179
2131273	364	20127710	297	13011.1430	186	13041.1230	179
2231265	383	20127712	296	13011.1440	186	13041.1240	179
2232265	356	20127713	296	13011.1460	186	13041.1260	179
20122200	298	20127715	295	13011.14MAGIC	246	13041.12AZ	193
20122201	298	20141052	295	13011.14RGB	193	13041.1430	186
20122203	298	20141070	295	13011.14VD	193	13041.1440	186
20122212	299	20141074	295	130111.0427	142	13041.1460	186
20122213	300	20141112	296	130111.0430	142	13041.14RGB	193
20122236	296	20141133	295	130111.0440	142	13045.0727	149
20122248	296	20142010	322	130111.0460	142	13045.0730	149
20122260	307	20142011	322	130111.0927	152	13045.0740	149
20122426	313	20142013	322	130111.0930	152	13045.0760	149
20122442	268	20142024	297	130111.0940	152	13045.1227	180

INDÍCE DE REFERÊNCIAS

ÍNDICE DE REFERENCIA

Referência	Pág.	Referência	Pág.	Referência	Pág.	Referência	Pág.
13045.1230	180	131121.1065	165	131525.1560	202	1321515.1040	171
13045.1240	180	131145.0927	157	1315321.14RGB+27	195	1321515.1060	171
13045.1260	180	131145.0930	157	1315321.14RGB+40	195	1321541.1027	166
13015.1430	186	131145.0940	157	1315326.14RGB+30	195	1321541.1030	166
13015.1440	186	131146.0927	157	1315326.14RGB+40	195	1321541.1040	166
13015.1460	186	131146.0930	157	1315721.0527	143	1321545.1027	171
13045.1430	186	131146.0940	157	1315721.0530	143	1321545.1030	171
13045.1440	186	131146.0960	157	1315721.0540	143	1321545.1040	171
13045.1460	186	1311526.1927	214	1317321.19RGB	213	1321545.1060	171
13045.14RGB	193	1311526.1930	214	1319621.4027	223	132166.1027	99
13047.1230	181	1311526.1940	214	1319621.4030	223	132166.1030	99
13047.1240	181	1311526.1960	214	1319621.4040	223	132166.1040	99
13047.1260	181	1311621.2027	219	1319621.4060	223	1322127.1030	47
13051.14RGB	194	1311621.2030	219	1320621.1427	188	1322127.1030	109
13057.14RGB	194	1311621.2040	219	1320621.1430	188	1322127.1040	47
13061.18RGBW	211	1311621.2060	219	1320621.1440	188	1322127.1040	109
13061.18RGBWW	212	1311621.2627	221	13211.1830	210	1322127.1060	47
13065.18RGBWW	212	1311621.2630	221	13211.1840	210	1322127.1060	109
1307171.18DIG	247	1311621.2640	221	13211.1860	210	1322127.10RGB	47
1307171.18DIGNW	250	1311621.2660	221	1321146.1527	105	1322127.10RGB	109
1307171.18DIGWW	250	13116341.2030	219	1321146.1530	105	1322136.1027	91
13081.28RGBWA	220	13116341.2040	219	1321146.1540	105	1322136.1030	91
1310146.14RGB	105	1312126.1427	196	1321286.1027	80	1322136.1040	91
1310221.1518	199	1312126.1430	196	1321286.1030	80	132246.1027	114
1310221.1522	199	1312126.1440	196	1321286.1040	80	132246.1030	114
1310221.1525	199	1312126.1460	196	1321286.1050	80	132246.1040	114
13111111.1927	154	1312157.1430	197	132136.1527	206	1322521.20CT	217
13111111.1930	154	1312157.1440	197	132136.1530	206	132256.1027	118
13111111.1940	154	1312157.1460	197	132136.1540	206	132256.1030	118
13111111.1960	154	1313116.15RGBWW	115	132136.1560	206	132256.1040	118
13111191.0927	156	1313226.1027	92	132138.1527	206	1323116.1027	102
13111191.0930	156	1313226.1030	92	132138.1530	206	1323116.1030	102
13111191.0940	156	1313226.1040	92	132138.1540	206	1323116.1040	102
1311121.1427	191	1313246.1027	104	132138.1560	206	132314171.1127	176
1311121.1430	191	1313246.1030	104	132141.0927	156	132314171.1130	176
1311121.1440	191	1313246.1040	104	132141.0930	156	132314171.1140	176
1311121.1460	191	13141.07RGB	150	132141.0940	156	132314171.1160	176
13111341.1427	191	1314117.1030	50	132141.0960	156	13231441.1427	190
13111341.1430	191	1314117.1030	112	13215.1830	210	13231441.1430	190
13111341.1440	191	1314117.1040	50	13215.1840	210	13231441.1440	190
13111341.1460	191	1314117.1040	112	13215.1860	210	13231441.1460	190
13111451.41224	163	1314117.1060	50	132151.0727	147	1323191.14RGB	192
13111451.41227	163	1314117.1060	112	132151.0730	147	13234151.19CT	215
13111451.41230	163	1314117.10RGB	50	132151.0740	147	1323421.1527	200
13111451.41240	163	1314117.10RGB	112	132151.0760	147	1323421.1530	200
13111451.41250	163	13145.07RGB	150	132151.0927	159	1323421.1540	200
13111461.1527	203	13149115.0627	96	132151.0930	159	132355.0922	161
13111461.1530	203	13149115.0630	96	132151.0940	159	132355.0927	161
13111461.1540	203	13149115.0640	96	132151.0960	159	132355.0930	161
13111461.1560	203	131521.1527	201	132151.1427	184	132355.0940	161
13111471.1027	153	131521.1530	201	132151.1430	184	132355.0957	161
13111471.1030	153	131521.1540	201	132151.1440	184	1323621.3427	222
13111471.1040	153	131521.1550	201	132151.1460	184	1323621.3430	222
13111471.1065	153	131521.1560	201	1321511.1027	166	1323621.3440	222
131121.1027	165	131525.1527	202	1321511.1040	166	1323621.3460	222
131121.1030	165	131525.1530	202	1321511.1060	166	13237266.1427	185
131121.1040	165	131525.1540	202	1321515.1030	171	13237266.1430	185

ÍNDICE DE REFERÊNCIAS

ÍNDICE DE REFERENCIA

Referência	Pág.	Referência	Pág.	Referência	Pág.	Referência	Pág.
13237266.1440	185	13281016.0630	78	133213.0627	87	13401447.0940	183
13237266.1460	185	13281016.0640	78	133213.0630	87	13401447.0960	183
1324116.1027	116	1328116.1027	79	133213.0640	87	13414481.12	178
1324116.1030	116	1328116.1030	79	13324.1527	202	1342116.1227	124
1324116.1040	116	1328116.1040	79	13324.1530	202	1342116.1230	124
1324116.10RGBWW	116	1328116.1065	79	13324.1540	202	1342116.1240	124
1324521.1827	209	13281241.1427	190	13325.0927	98	1343116.1227	125
1324521.1830	209	13281241.1430	190	13325.0930	98	1343116.1230	125
1324521.1840	209	13281241.1440	190	13325.0937	98	1343116.1240	125
1324521.1860	209	13281241.1460	190	133412151.20CT	218	13461116.1027	81
13246.1027	89	1328166.10RGB	99	13351151.10DW	167	13461116.1030	81
13246.1030	89	13285171.1127	176	133612191.1027	168	13461116.1040	81
13246.1040	89	13285171.1130	176	133612191.1030	168	135.0527	49
13251.1527	204	13285171.1140	176	133612191.1040	168	135.0527	111
13251.1530	204	1328525.1527	207	133612191.1060	168	135.0530	49
13251.1540	204	1328525.1530	207	133612266.0927	160	135.0530	111
13251.1560	204	1328525.1540	207	133612266.0930	160	135.0540	49
1325116.1027	120	1328525.1560	207	133612266.0940	160	135.0540	111
1325116.1030	120	1328527.1030	174	133612266.0950	160	135.0565	49
1325116.1040	120	1328527.1040	174	1336123.1027	119	135.0565	111
1325116.10RGBWW	120	1328527.1060	174	1336123.1030	119	135.07RGB	49
13251227.1027	46	13285311.1027	175	1336123.1040	119	135.07RGB	111
13251227.1027	108	13285311.1030	175	1336123.12DIGWW	251	135.09RGB	49
13251227.1030	46	13285311.1040	175	133612377.1030	172	135.09RGB	111
13251227.1030	108	13285311.1060	175	133612377.1040	172	135.1027	49
13251227.1040	46	13285317.1027	175	13371411.1627	208	135.1027	111
13251227.1040	108	13285317.1030	175	13371411.1630	208	135.1030	49
13251227.1065	46	13285317.1040	175	13371411.1640	208	135.1030	111
13251227.1065	108	13285317.1060	175	13371411.1660	208	135.1040	49
1325151.1027	169	13285461.1127	177	13381301.3227	29	135.1040	111
1325151.1030	169	13285461.1130	177	13381301.3230	29	135.1065	49
1325151.1040	169	13285461.1140	177	13381301.3240	29	135.1065	111
1325151.1060	169	13285461.1160	177	13381301.3260	29	135.12RGB	49
1325156.1027	169	13291.1530	198	1339115.0727	90	135.12RGB	111
1325156.1030	169	13291.1540	198	1339115.0730	90	135.1527	49
1325156.1040	169	13291.1560	198	1339115.0740	90	135.1527	111
1325156.1060	169	13291241.15RGB	205	1340115.0727	101	135.1530	49
13254.1527	204	1329291.0927	158	1340115.0730	101	135.1530	111
13254.1530	204	1329291.0930	158	1340115.0740	101	135.1540	49
13254.1540	204	1329291.0940	158	1340126.0927	162	135.1540	111
13254.1560	204	1329541.15RGB	205	1340126.0930	162	135.1565	49
1325461.0627	144	1329541.18RGBW	205	1340126.0940	162	135.1565	111
1325461.0630	144	13301301.1227	28	1340126.0965	162	136.0527	48
1325461.0640	144	13301301.1230	28	13401341.0927	182	136.0527	110
1325461.0660	144	13301301.1240	28	13401341.0930	182	136.0530	48
13255341.1027	166	13301301.1260	28	13401341.0940	182	136.0530	110
13255341.1030	166	13305331.12DIGWW	249	13401341.0960	182	136.0540	48
13255341.1040	166	133121.0927	151	13401441.0927	182	136.0540	110
13256.1027	100	133121.0930	151	13401441.0930	182	136.0565	48
13256.1030	100	133121.0940	151	13401441.0940	182	136.0565	110
13256.1040	100	13315.0927	88	13401441.0960	182	136.07RGB	48
13256.1227	103	13315.0930	88	13401445.0927	183	136.07RGB	110
13256.1230	103	13315.0940	88	13401445.0930	183	136.09RGB	48
13256.1240	103	13315331.18DIG	248	13401445.0940	183	136.09RGB	110
13268227.10RGB	46	1332123.1027	117	13401445.0960	183	136.1027	48
13268227.10RGB	108	1332123.1030	117	13401447.0927	183	136.1027	110
13281016.0627	78	1332123.1040	117	13401447.0930	183	136.1030	48

INDÍCE DE REFERÊNCIAS

ÍNDICE DE REFERENCIA

Referência	Pág.	Referência	Pág.	Referência	Pág.	Referência	Pág.
136.1030	110	1394146.0627	97	201153.28	270	201266.260	273
136.1040	48	1394146.0630	97	201161.1100	266	201266.290	273
136.1040	110	1394146.0640	97	201161.1150	266	20127360BI	303
136.1065	48	1394146.0653	97	201161.1200	266	20127484N	297
136.1065	110	139741.0727	145	201161.1320	266	201281.1010	355
136.12RGB	48	139741.0730	145	201161.135	266	201281.1100	268
136.12RGB	110	139741.0740	145	201161.1350	266	201281.130	268
136.1527	48	139741.0760	145	201161.150	266	201281.160	268
136.1527	110	1512127.560	43	201161.175	266	201281.2100	268
136.1530	48	1512227.5RGB	43	201161.2100	266	201281.2160	268
136.1530	110	1512327.1360	43	201161.2150	266	201281.230	268
136.1540	48	1512427.12RGB	43	201161.2200	266	201281.260	268
136.1540	110	151317.2030	40	201161.2320	266	201371.1350	266
136.1565	48	151317.2060	40	201161.235	266	201371.1500	266
136.1565	110	151317.25RGB	38	201161.2350	266	201371.1750	266
13613136.1027	93	1516617.17RGB	37	201161.250	266	201371.2350	266
13613136.1030	93	1517717.24RGB	39	201161.275	266	201371.2500	266
13613136.1040	93	1517717.2560	39	201161.4150	252	201371.2750	266
13613136.10RGB	93	15717.15RGB	36	201161.7600	266	201371.4200	252
136246.11RGB	115	15717.20RGB	36	201171.115	266	201371.4350	252
136256.11RGB	118	19.03001	55	201171.125	266	20141114IP	296
1368136.10RGB	91	19.05001	55	201171.215	266	201481.919	391
137.482	83	19.06001	55	201171.225	266	20151370BI	302
137.483	83	191121.1327	25	201176.1100	271	201535.527	310
137.484	83	191121.1330	25	201176.1150	271	201535.6114	310
137.486	83	191121.1340	25	201176.118	271	2015535.4814	310
13751.1030	170	192121.827	25	201176.120	271	201561.112	267
13751.1040	170	192121.830	25	201176.135	271	201561.118	267
13751.1060	170	192121.840	25	201176.160	271	201561.130	267
13757.1030	170	193121.827	25	201176.2100	271	201561.16	267
13757.1040	170	193121.830	25	201176.2150	271	201561.160	267
13757.1060	170	193121.840	25	201176.218	271	201561.175	267
138.242	82	194125.1327	27	201176.220	271	201561.212	267
138.243	82	194125.1330	27	201176.235	271	201561.2120	267
138.244	82	194125.1340	27	201176.260	271	201561.2150	267
138.246	82	196124.1027	26	201176.4100	252	201561.218	267
13821.1424	187	196124.1030	26	201176.460	252	201561.2200	267
13821.1427	187	196124.1040	26	201211.1100	278	201561.2250	267
13821.1430	187	2011052.1150	282	201211.115	278	201561.230	267
13821.1440	187	2011052.175	282	201211.1150	278	201561.26	267
1391111.1427	155	2011052.2150	282	201211.130	278	201561.260	267
1391111.1430	155	2011052.2240	282	201211.160	278	201561.275	267
1391111.1440	155	2011052.275	282	201211.2100	278	201561.7150	267
1391111.1465	155	2011052.7240	282	201211.215	278	201561.7200	267
1391156.19CT	216	201116.116	273	201211.2150	278	201561.7250	267
139121.24UV	259	201116.125	273	201211.230	278	201561.775	267
1391275.1027	74	201116.216	273	201211.260	278	2015966.260	281
1391275.1030	74	201116.225	273	2012521.4322	312	2015966.260DA2	281
1391275.1040	74	201153.112	270	20125403BI	317	2015966.760	281
1391275.10RGB	74	201153.116	270	201266.1120	273	201689.1100	275
1391275.16RGBWW	74	201153.125	270	201266.1200	273	201689.115	275
1391275.2027	75	201153.135	270	201266.140	273	201689.130	275
1391275.2030	75	201153.18	270	201266.160	273	201689.160	275
139151.19CT	216	201153.212	270	201266.190	273	201689.2100	275
1394136.0627	84	201153.216	270	201266.2120	273	201689.215	275
1394136.0630	84	201153.225	270	201266.2200	273	201689.230	275
1394136.0640	84	201153.235	270	201266.240	273	201689.260	275

ÍNDICE DE REFERÊNCIAS

ÍNDICE DE REFERENCIA

Referência	Pág.	Referência	Pág.	Referência	Pág.	Referência	Pág.
201701.2200	266	202135.635	291	202401.9617	318	203535.1200	276
201801.130	269	202186.1527	294	202405.721	291	203535.2100	276
201801.160	269	202186.157	294	202405.734	291	203535.2150	276
201801.2100	269	202186.2515	293	202451.7735	292	203535.2200	276
201801.2150	269	202186.302	294	2024901.8352	386	203535.2320	276
201801.2200	269	202186.341	294	202535.4426	310	203535.275	276
201801.2240	269	202186.343	294	202535.443	310	203535.7240	276
201801.230	269	202186.352	294	202535.5242	310	203535.7320	276
201801.260	269	202186.363	294	202535.5243	310	205313.1100	288
2018010.1100	269	202186.3715	294	202535.5244	311	205313.1150	288
2018010.1132	269	202186.41	293	202535.6614	310	205313.1200	288
2018010.130	269	202186.415	293	202535.7845	310	205313.130	288
2018010.160	269	202186.43	293	202535.7945	311	205313.1300	288
2018010.2100	269	202186.442	293	202536.3414	311	205313.160	288
2018010.2150	269	202186.443	293	202536.5234	311	205313.2100	288
2018010.230	269	202186.47	293	202536.6414	311	205313.2150	288
2018010.260	269	202186.541	294	20271001.5742	284	205313.2200	288
2018352.1100	272	202186.68	294	202841.596	319	205313.230	288
2018352.1160	272	2021881.2150	280	202841.9960	292	205313.2300	288
2018352.124	272	2021881.240	280	20286.202	293	205313.260	288
2018352.140	272	2021881.275	280	20286.41	293	205801.1100	287
2018352.160	41	202191.25	312	202871.4750	303	205801.1150	287
2018352.160	272	202191.40	312	202871.8352	303	205801.136	287
2018352.2100	272	202191.60	312	202871.8353	303	205801.160	287
2018352.2160	272	202233.101	290	2028966.952	310	205801.2100	287
2018352.224	272	202233.105	291	202921.851	292	205801.2150	287
2018352.240	272	202233.12	290	202921.862	292	205801.236	287
2018352.260	272	202233.1210	290	202921.871	292	205801.260	287
2018411.7617	318	202233.1270	290	202921.882	292	2061011.2150	284
201881.160	65	202233.171	290	2029851.2100	349	2061011.2200	284
2018851.8146	308	202233.181	291	2029851.2150	349	2061011.2240	284
2018851.8147	308	202233.191	290	2029851.7100	349	2061011.7200	284
2018851.8248	309	202233.252	290	2029851.7150	349	2061011.7240	284
2018851.8249	309	202233.295	290	203146.1240	277	206561.2150	286
2019281.2150	286	202233.533	291	203146.1320	277	206561.2250	286
2019281.245	286	202233.75	290	203146.1600	277	206561.245	286
2019281.280	286	202233.770	291	203146.2320	277	206561.280	286
201929.116	270	202233.91	290	203146.2480	277	206851.4882	319
201929.135	270	202233.970	290	203146.2600	277	206851.814	319
201929.18	270	202245.482	294	203205.1150	277	206861.130	285
201929.216	270	2022521.2100	386	203246.1200	277	206861.160	285
201929.235	270	2022521.2150	386	203246.1300	277	206861.230	285
201929.28	270	2022521.275	386	203246.2100	277	206861.260	285
2019401.2100	284	202293.132	305	203246.2150	277	206861.730	285
2019401.260	284	202293.142	305	203246.2200	277	206861.760	285
2019451.7713	349	202293.151	305	203246.2240	277	2068610.1100	285
2019451.7741	349	202293.212	305	203246.2300	277	2068610.1120	285
2019451.8957	318	202293.241	305	203246.275	277	2068610.1150	285
2019535.4155	311	202293.245	305	2032881.64DA	355	2068610.1200	285
2019536.3441	311	202293.253	305	20331052.1150	282	2068610.1300	285
2019801.6098	292	202293.262	305	20331052.175	282	2068610.2100	285
2019871.4750	324	202293.6115	305	20331052.2150	282	2068610.2120	285
2019871.4751	324	202293.62	305	20331052.2240	282	2068610.2150	285
2019871.8352	324	202293.85	305	20331052.275	282	2068610.2200	285
2019871.8353	324	2023901.8139	386	20331052.7240	282	2068610.2300	285
2019901.434	317	2023901.9114	386	203535.1100	276	2068610.7100	285
2019901.8154	317	202401.7439	292	203535.1150	276	2068610.7150	285

INDÍCE DE REFERÊNCIAS

ÍNDICE DE REFERENCIA

Referência	Pág.	Referência	Pág.	Referência	Pág.	Referência	Pág.
2068610.7200	285	211218.1384	330	2121244.RGBW	335	2130217.4216	339
2068610.7300	285	211218.196	329	2122124.104	253	2130218.6144	339
206976.2400	285	211218.3400	287	21221251.103	253	2130253.3480	370
206976.2500	285	211218.3400	329	2122126.105	253	2130278.4240	339
207411.2333	314	2112248.3400	358	2122127.105	253	2131213.31000	363
207411.2433	314	2112252.3100	359	212218.ROT	385	2131218.6192	362
207411.2533	314	2112252.31000	359	2122218.DIM4	384	2131224.4384	362
207516.1150	280	211226.3	355	2122244.DA	383	213123.DIM4	365
207516.1200	280	2112270.DA	355	2122246.4480	381	2131234.3400	387
207516.1320	280	211243.4288	333	2122246.6720	381	2131248.3400	362
207516.2150	280	211243.4480	333	2122246.RGB+W+WW	384	2131253.3920	363
207516.2200	280	211243.4600	334	2122248.3200	382	213144.2CH	335
207516.2360	280	211243.696	332	2122253.3430	382	2132177.46	347
20766.1120	281	211244.3240	287	2122753.34CH	384	213219.DIM1	330
20766.1120BLE	350	211244.3240	331	2124218.5480	358	213219.DIM4	329
20766.1120DA2	281	211244.4120	338	2124234.44480	387	2132272.2	354
20766.1200	281	211244.4144	338	2125248.3576	389	2132272.4	354
20766.1200BLE	350	211244.4RGB	338	2126218.5480	357	213262.DIM3	365
20766.1200DA2	281	211244.4RGB+CCT	338	2126228.5600	357	213262.RGBWW+W	365
20766.140	281	211244.4RGBW	38	212644.6360	331	2133274.3400	381
20766.160	281	211244.4RGBW	338	2127218.4240	369	2137244.115	385
20766.160BLE	350	211245.4288	333	2127254.3300	368	2138227.6960	341
20766.160DA2	281	2113218.6288	341	2127254.3400	368	2138229.3200	343
20766.190	281	2113224.4240	341	2127254.PORT	370	2138230.32300	344
20766.190DA2	281	2113230.3650	344	2127255.2	377	2138230.3390	344
20766.2120	281	2113244.1720	331	2127255.4FIO	377	2138230.3920	344
20766.2120BLE	350	2114244.4768	337	2127255.8	377	2138238.3460	343
20766.2120DA2	281	2114269.5196	62	2127257.3500	370	2138240.DA25	342
20766.2200	281	2114445.1086	337	2127258.0110	369	2139216.RGB	42
20766.2200BLE	350	2114518.1460	62	2127258.3150	368	2139518.10120	62
20766.2200DA	281	2114518.448	62	2127258.4120	369	2140518.10120	62
20766.240	281	2114518.496	62	2127258.4240	369	214222.31000	389
20766.260BLE	350	21151.224	258	2127258.DA20	369	214417.1720	395
20766.290	281	2116224.6150	329	2127259.1	374	214722.440CH	388
20766.290DA2	281	2117227.4144N	341	2127259.1CCT	374	215218.4120	357
20766.7120	281	2117227.6240	341	2127259.1RGBW	374	215422.4960	388
20766.7200	281	2117227.6288	341	2127260.2	373	216217.4480	395
20766.7200DA2	281	2117229.3200	287	2127260.4	373	216218.4360	395
20766.740	281	2117229.3200	343	2127260.8	373	216248.3600	395
20766.760	281	2117230.123000	344	2127260.DIM1	373	216433.4560	395
20766.790	281	2117230.132300	344	2127260.RGBW1	373	219225.5480	391
20766.790DA2	281	2117240.16	342	2127261.30	371	2211511.19	260
209191.25	312	2117240.32	342	2127261.4	372	221152.19	260
209191.40	312	2117240.64	342	2127261.4DIM	371	2213226.1BR	345
209191.60	312	2117253.3480	343	2127261.4RGB	371	2213226.2BR	345
209451.3317	314	2119744.8RGBW	335	2127262.1	374	2213226.74P	345
20981.1010	355	2119749.RGB+W+WW	388	2127262.1ES	374	2213226.8BR	345
2110226.3576	287	2120178.4BR	335	2127263.1	374	2213226.8PT	345
2110226.3576	358	2120178.4PT	335	2127263.3	374	2213227.3	342
2110252.5480	356	2120244.DIM	332	2127263.4	374	2213227.DA	342
2110373.2DA	353	2120244.DIM4	332	2127264.MOVE	375	2213227.DMX	347
2110752.CCT	356	2120244.RGBW	334	2127264.PORTA	376	2213227.KNX	347
2110779.2DA	356	2120244.RGBW+WW	335	2127264.TOUCH	375	2213227.WEB	347
2111226.5360	336	2120244.RGBW4	334	2127265.PORTA	376	2213230.3	348
2111271.4120	336	2120253.1DIG	253	2127268.4120	63	221325.1121	348
211174.3360	331	2120271.1CT	336	2127268.4120	369	2213274.6	345
211218.1240	330	2121244.DIM	332	2129744.8DIM	335	2213327.DA50	342

ÍNDICE DE REFERÊNCIAS

ÍNDICE DE REFERENCIA

Referência	Pág.	Referência	Pág.	Referência	Pág.	Referência	Pág.
221334.8	348	271215.0154	32	FXM67	425	PFA121.3	421
2222251.DA	383	271215.0730	32	FXM67	426	PFA122	421
2222251.POWER	383	271215.0760	33	L4411CM2	287	PFA122.3	421
2222266.DIM4	385	271215.07CCT	33	NT1.1616	128	PFA1231	491
2222267.4CH	385	271215.07RGB	33	NT2.1010	128	PFA1231.3	491
22237277.360DA	348	272215.260	33	NT3.1220	129	PFA1232	491
222417.RGB	42	274215.0565	33	NT3.612	129	PFA1238	491
2225219.196	65	27546.0370	32	ORACC190	407	PFA1241	493
2226262.1310	337	276216.0770	32	ORACC380	407	PFA1241.3	493
2226262.1330	337	277216.170	32	ORACCX189	406	PFA1242	493
2226262.IR	64	ACD0109	486	ORACCX197	406	PFA1248	493
2226262.PORTA	63	ACK42647	477	ORACCX215-2600	406	PFA1251	422
2227262.MAD	64	ACK42659	477	ORACCX217-2600	406	PFA1252	422
2227262.MOV	64	BF1231	491	ORAC SX179	407	PFA1257	422
2229262.114	63	BFX123	491	PAR123	491	PFA128	421
2229262.114	337	CE131241	504	PF101	414	PFA1281	495
2234274.2	345	CI131241	504	PF102	417	PFA1291	424
223640.1233	260	DFG00046	411	PF105	425	PFA1292	424
223640.125	260	DFG00074	411	PF11011	414	PFA1301	490
223640.33	260	DFG00097	427	PF11011	417	PFA1308	490
223640.5	260	DFG00098	427	PF201	432	PFA131	415
2237218.4RGBW	346	DFG00106	409	PFA11081	490	PFA131.3	415
2237218.TOUCH	346	DFG00106.6	409	PFA11081.3	490	PFA1310	415
2237219.4DIM	346	FX101	414	PFA111	413	PFA131231	504
2237219.5ROD	346	FX101	417	PFA111.3	413	PFA131241	504
2237226.4	345	FX102	417	PFA1110	413	PFA131262	505
224218.1	261	FX105	425	PFA1111	411	PFA131321	505
224219.1	261	FX11	413	PFA111161	488	PFA131331	507
225218.1	261	FX110	416	PFA111168	488	PFA132	415
225219.1	261	FX110	419	PFA1112	411	PFA13271	507
226416.RGB	41	FX110	421	PFA111351	488	PFA13272	507
227111.19	260	FX110	479	PFA111358	488	PFA13281	506
227112.19	260	FX11081	490	PFA1114	494	PFA13282	506
227122.18	261	FX111	411	PFA11142	494	PFA1361	480
227211.19	260	FX118	413	PFA1118	411	PFA1361.3	480
227212.19	260	FX119	412	PFA112	413	PFA1362	480
227311.19	260	FX123	491	PFA112.3	413	PFA1362.3	480
227312.19	260	FX13	415	PFA11241	487	PFA1368	480
227322.18	261	FX181171	499	PFA11241.3	487	PFA1368.3	480
227342.78	261	FX1841	417	PFA11248	487	PFA137	415
227411.19	260	FX1871	409	PFA11311	481	PFA138	415
227412.19	260	FX2099	420	PFA11311.3	481	PFA141382	472
227742.78	261	FX30	490	PFA11318	481	PFA14321	497
227782.18	261	FX67	425	PFA11318.3	481	PFA14322	497
228521.125	419	FX67	426	PFA117	413	PFA14331	497
228521.3	419	FX6891	427	PFA117.3	413	PFA14332	497
228521.5	419	FX7921	485	PFA118	413	PFA14802	472
228521.Y	478	FXF123	491	PFA118.3	413	PFA151	423
228521.Y1	478	FXG01057	411	PFA1191	412	PFA151.3	423
228521A	419	FXG23202	500	PFA1191.3	412	PFA152	423
228521U	419	FXG23202	501	PFA1192	412	PFA152.3	423
228521UA	419	FXL11	413	PFA1192.3	412	PFA158	423
228521UA120	419	FXM11	413	PFA1197	412	PFA158.3	423
228521UT	419	FXM123	491	PFA1197.3	412	PFA1591	436
228629.2	487	FXM13	415	PFA1198	412	PFA1592	436
23151.1214	257	FXM136	481	PFA1198.3	412	PFA1601	418
231551.1014	256	FXM160	418	PFA121	421	PFA1601.3	418

INDÍCE DE REFERÊNCIAS

ÍNDICE DE REFERENCIA

Referência	Pág.	Referência	Pág.	Referência	Pág.	Referência	Pág.
PFA1602	418	PFA21710.3	431	PFA2862	472	PFA8242	468
PFA1602.3	418	PFA2172	431	PFA2867	472	PFA8251	469
PFA1608	418	PFA2172.3	431	PFA41051	479	PFA8252	469
PFA1608.3	418	PFA2177	431	PFA41058	479	PFA8261	471
PFA17431	492	PFA2177.3	431	PFA41061	479	PFA8262	471
PFA17432	492	PFA2178	431	PFA41068	479	PFA8311	473
PFA17438	492	PFA2181	435	PFA5351	478	PFA8312	473
PFA181171	499	PFA2181.3	435	PFA5352	478	PFA8341	473
PFA181181	458	PFA2182	435	PFA61391	425	PFA8341.3	473
PFA181182	458	PFA2187	435	PFA6371	496	PFA8342	473
PFA181251	454	PFA2188	435	PFA6381	426	PFA841	471
PFA181361	458	PFA2191	431	PFA6382	426	PFA842	471
PFA181362	458	PFA2192	431	PFA6391	496	PFA8441	455
PFA1831	417	PFA2197	431	PFA6397	496	PFA8442	455
PFA1841	417	PFA2198	431	PFA671	425	PFA8451	456
PFA1848	417	PFA2198.3	431	PFA671.3	425	PFA8451.3	456
PFA1851	416	PFA2231	443	PFA6710	425	PFA8657	466
PFA1852	416	PFA2232	443	PFA672	425	PFA8657.3	466
PFA1858	416	PFA2232.3	443	PFA672.3	425	PFA8667	466
PFA1871	409	PFA2401	441	PFA677	425	PFA8667.3	466
PFA18797	459	PFA2401.3	441	PFA678	425	PFA8731	463
PFA18881	453	PFA2402	441	PFA678.3	425	PFA8731.3	463
PFA191	419	PFA2402.3	441	PFA6891	427	PFA8732	463
PFA191.3	419	PFA2421	436	PFA761	484	PFA8732.3	463
PFA192	419	PFA2422	436	PFA761.3	484	PFA8737	463
PFA192.3	419	PFA2428	436	PFA7611	484	PFA8737.3	463
PFA198	419	PFA2461	438	PFA7611.3	484	PFA8738	463
PFA198.3	419	PFA2461.3	438	PFA7921	485	PFA8738.3	463
PFA19972	462	PFA2462	438	PFA7921.3	485	PFA8761	465
PFA19977	462	PFA2462.3	438	PFA7931	485	PFA8761.3	465
PFA19982	464	PFA2468	438	PFA7931.3	485	PFA8762	465
PFA19987	464	PFA2468.3	438	PFA7951	485	PFA8762.3	465
PFA201001	422	PFA2471	434	PFA7951.3	485	PFA8767	465
PFA201002	422	PFA2471.3	434	PFA81021	454	PFA8767.3	465
PFA201008	422	PFA2472	434	PFA81111	503	PFA8768	465
PFA20991	420	PFA2472.3	434	PFA81112	503	PFA8768.3	465
PFA20992	420	PFA2477	434	PFA81121	505	PFA8771	456
PFA2101	437	PFA2477.3	434	PFA81122	505	PFA8771.3	456
PFA2101.3	437	PFA2478	434	PFA81191	464	PFA8772	456
PFA2102	437	PFA2478.3	434	PFA81192	464	PFA8772.3	456
PFA2102.3	437	PFA2741	433	PFA81201	458	PFA8777	456
PFA211271	446	PFA2741.3	433	PFA81201.H90	458	PFA8777.3	456
PFA21131	500	PFA2742	433	PFA81201.VE90	458	PFA8778	456
PFA2121	440	PFA2742.3	433	PFA81201.VI90	458	PFA8778.3	456
PFA2121.3	440	PFA2747	433	PFA81211	503	PFA8781	453
PFA2122	440	PFA2747.3	433	PFA81212	503	PFA8781.3	453
PFA2122.3	440	PFA2748	433	PFA81221	452	PFA8782	453
PFA21401	432	PFA2748.3	433	PFA81281	459	PFA8782.3	453
PFA2161	442	PFA2751	439	PFA81291	454	PFA8787	453
PFA2161.3	442	PFA2751.3	439	PFA81371	458	PFA8787.3	453
PFA2162	442	PFA2752	439	PFA81372	458	PFA8788	453
PFA2162.3	442	PFA2752.3	439	PFA81431	452	PFA8788.3	453
PFA2168	442	PFA2757	439	PFA8201	460	PFA8811	457
PFA2168.3	442	PFA2757.3	439	PFA8202	460	PFA8811.H90	457
PFA2171	431	PFA2758	439	PFA8211	473	PFA8811.VE90	457
PFA2171.3	431	PFA2758.3	439	PFA8212	473	PFA8811.VI90	457
PFA21710	431	PFA2861	472	PFA8241	468	PFA8818	457

ÍNDICE DE REFERÊNCIAS

ÍNDICE DE REFERENCIA

Referência	Pág.	Referência	Pág.	Referência	Pág.	Referência	Pág.
PFA8821	452	PFG23322	447	TP1301	490	TP2162	442
PFA8941	457	PFK0788	477	TP1308	490	TP2162AL	442
PFD0081	410	PFS1140	494	TP131	415	TP2171	431
PFD0083	410	PFS1140	495	TP131231	504	TP2172	431
PFD0085	410	PFS11402	494	TP131241	504	TP2178	431
PFD0101	414	PFS11402	495	TP131262	505	TP2181	435
PFD0103	414	PFS1331	497	TP131321	505	TP2182	435
PFD0105	414	PFT101	414	TP132	415	TP2188	435
PFD0181	410	PFT102	417	TP1361	480	TP2191	431
PFD0183	410	PFT201	432	TP1362	480	TP2192	431
PFD0185	410	PM11311	481	TP138	415	TP2198	431
PFD0523	487	PM11311.3	481	TP14321D	497	TP2231	443
PFD0570	428	PM11318	481	TP14321E	497	TP2232	443
PFD0741	486	PM11318.3	481	TP14322D	497	TP2402AL	441
PFD5081	430	PM1231	491	TP14322E	497	TP2421	436
PFD5083	430	SAL1231	491	TP14331D	497	TP2422	436
PFD5085	430	SALF1231	491	TP14331E	497	TP2471	434
PFD5352	449	TP101	414	TP14332D	497	TP2472	434
PFD5361	447	TP102	417	TP14332E	497	TP2478	434
PFD5371	450	TP105	425	TP14802	472	TP271D	507
PFD5390	448	TP11081	490	TP151	423	TP271E	507
PFD5394	448	TP111	413	TP151AL	423	TP272D	507
PFD5741	486	TP1110	413	TP152	423	TP272E	507
PFD5781	486	TP1111	411	TP158	423	TP281D	506
PFG01002	498	TP111161	488	TP158AL	423	TP281E	506
PFG01003	498	TP111168	488	TP1591D	436	TP282D	506
PFG01004	498	TP1112	411	TP1591E	436	TP282E	506
PFG01050	411	TP1118	411	TP1592D	436	TP2861D	472
PFG01051	411	TP112	413	TP1592E	436	TP2861E	472
PFG01052	411	TP11241D	487	TP1601	418	TP2862D	472
PFG01060	409	TP11241E	487	TP1602	418	TP2862E	472
PFG01062	409	TP11248D	487	TP1608	418	TP41061	479
PFG01080	498	TP11248E	487	TP181171	499	TP41061AL	479
PFG02032	445	TP11311	481	TP1831	417	TP41068	479
PFG02034	446	TP11311AL	481	TP1841	417	TP41068AL	479
PFG02036	449	TP11318	481	TP1848	417	TP5351	478
PFG02040	474	TP11318AL	481	TP1851	416	TP5352	478
PFG02042	461	TP118	413	TP1871	409	TP6381D	426
PFG02044	428	TP1191	412	TP18797	459	TP6381E	426
PFG02045	461	TP1192	412	TP191	419	TP6382D	426
PFG02050	470	TP1198	412	TP191AL	419	TP6382E	426
PFG02056	470	TP121	421	TP192	419	TP671	425
PFG02090	496	TP121AL	421	TP201	432	TP6710	425
PFG02091	496	TP122	421	TP201002	422	TP672	425
PFG02230	450	TP1231	491	TP201008	422	TP678	425
PFG03040	474	TP1231R	491	TP20991	420	TP6891	427
PFG05050	498	TP1232	491	TP20992	420	TP761	484
PFG23100	427	TP1238	491	TP2101	437	TP7611	484
PFG23168	500	TP1241	493	TP2101AL	437	TP7921	485
PFG23169	500	TP1242	493	TP2102	437	TP7931	485
PFG23170	500	TP1251	422	TP2108	437	TP7931+51	485
PFG23171	501	TP1252	422	TP21131	500	TP7951	485
PFG23172	501	TP1281	495	TP2121	440	TP81021	454
PFG23173	501	TP12812	495	TP2121AL	440	TP81021	454
PFG23174	447	TP128AL	421	TP2122	440	TP81111	503
PFG23176	447	TP1291	424	TP2161	442	TP81121	505
PFG23320	447	TP1292	424	TP2161AL	442	TP81192	464

INDÍCE DE REFERÊNCIAS

ÍNDICE DE REFERENCIA

Referência	Pág.	Referência	Pág.	Referência	Pág.	Referência	Pág.
TP81211	503	TPD8681	430	TPF7921	485		
TP81212	503	TPD8682	430	TPF7931	485		
TP81221	452	TPD9100	414	TPF7931+51	485		
TP8211	473	TPD9101	414	TPF7951	485		
TP8212	473	TPD9102	414	TPF81021	454		
TP8241	468	TPD9160	410	TPF81021	454		
TP8242	468	TPD9161	410	TPF81121	505		
TP8251	469	TPD9162	410	TPF81211	503		
TP8252	469	TPD9170	410	TPF81212	503		
TP8311D	473	TPD9171	410	TPF8771	456		
TP8311E	473	TPD9172	410	TPF8772	456		
TP8312D	473	TPD9180	430	TPF8778	456		
TP8312E	473	TPD9181	430	TPF8781	453		
TP8341D	473	TPD9182	430	TPF8782	453		
TP8341E	473	TPD9600	414	TPF8788	453		
TP8342D	473	TPD9601	414	TPG01005	498		
TP8342E	473	TPD9602	414	TPG01006	498		
TP8441D	455	TPD9660	410	TPG01007	498		
TP8441E	455	TPD9661	410	TPG01045	498		
TP8442D	455	TPD9662	410	TPG01055	411		
TP8442E	455	TPD9670	410	TPG01065	409		
TP8451	456	TPD9671	410	TPG023001	445		
TP8731	463	TPD9672	410	TPG023003	446		
TP8732	463	TPD9680	430	TPG023005	449		
TP8738	463	TPD9681	430	TPG023007	450		
TP8761	465	TPD9682	430	TPG023015	428		
TP8762	465	TPD9780	428	TPG023017	461		
TP8768	465	TPE1141	494	TPG23011	461		
TP8811	457	TPE11412	494	TPG23150	427		
TP8811	458	TPE1142	494	TPG23197	500		
TP8821	452	TPE201	460	TPG23197	501		
TP8821	453	TPE202	460	TPG23198	500		
TPA111	413	TPF101	414	TPG23198	501		
TPA1310	415	TPF11081	490	TPG23199	500		
TPD0511	449	TPF111	413	TPG23199	501		
TPD0570	428	TPF112	413	TPH111	413		
TPD1021	486	TPF14802	472	TPH112	413		
TPD1031	486	TPF151	423	TPH118	413		
TPD1041	486	TPF152AL	423	TPK42633	477		
TPD1141	494	TPF181171	499	TPK42641	477		
TPD11412	494	TPF1871	409	TPK42644	477		
TPD1142	494	TPF19971	462	TPR2171	431		
TPD201	460	TPF19972	462	TPR21710	431		
TPD202	460	TPF19981	464	TPR2178	431		
TPD8040	414	TPF19982	464	TPS11081	485		
TPD8041	414	TPF19987	464	TPS11081	490		
TPD8042	414	TPF201091	488				
TPD8201	487	TPF201098	488				
TPD8231	449	TPF2741	433				
TPD8390	428	TPF2742	433				
TPD8660	410	TPF2748	433				
TPD8661	410	TPF2751	439				
TPD8662	410	TPF2752	439				
TPD8670	410	TPF2758	439				
TPD8671	410	TPF6891	427				
TPD8672	410	TPF761	484				
TPD8680	430	TPF7611	484				

CONDIÇÕES DE VENDA | CONDICIONES DE VENTA

As presentes condições gerais de venda regulam o processo de trocas comerciais entre a empresa Elta – Iluminação, Lda e os seus clientes na venda e compra dos artigos comercializados da marca MOTAKO.

Las presentes condiciones generales de venta regulan el proceso de intercambios comerciales entre la empresa Elta – Iluminação, Lda y sus clientes en la compraventa de Productos vendidos bajo la marca MOTAKO.

ENCOMENDAS | PEDIDOS

As encomendas poderão ser efetuadas por email para comercial@motako.pt ou por impossibilidade deste, poderá ser realizada via telefone.

Los pedidos se pueden realizar por correo electrónico a comercial@motako.pt o por su imposibilidad, se puede hacer por teléfono.

ENTREGAS | ENTREGAS

As encomendas serão entregues por transportadora entre 24h a 72h, sendo acrescido o valor de transporte às encomendas (valor sob consulta). A Elta, Lda não se responsabiliza por quaisquer atrasos de entrega realizados pela transportadora. É solicitado ao cliente que verifique sempre as condições do material rececionado, pois caso apresente danos exteriores deverá salvaguardar-se no documento de entrega "sujeito a conferência".

Los pedidos se entregarán por transportista en un plazo de entre 24 y 72 horas, añadiéndose el coste del transporte a los pedidos (coste a consultar). Elta, Lda no es responsable de los retrasos en la entrega causados por el transportista. Se solicita al cliente verificar siempre las condiciones del material recibido, ya que si presenta daños externos, debe ser resguardado en el albarán de entrega "sujeto a verificación".

Relativamente às linhas de luz, o prazo de entrega pode variar entre 2 a 3 semanas, por se tratar de um produto muito específico, produzido nas dimensões que o cliente pretende e com os acabamentos e temperatura de luz pretendidos.

Respecto a las líneas ligeras, el plazo de entrega puede variar entre 2 a 3 semanas, ya que es un producto muy específico, producido en las dimensiones que el cliente quiere y con los acabados y temperatura de luz deseados.

DEVOLUÇÕES | DEVOLUCIONES

São somente aceites devoluções de artigos, do nosso catálogo MOTAKO, após 15 dias da data da fatura, pelas razões de não satisfação do produto, sendo que deverão apresentar-se na caixa original e de forma cuidada. As devoluções deverão ser previamente solicitadas à nossa empresa e em caso de aprovação deverão ser enviadas para o nosso armazém com respetivo documento e referênciação de fatura de compra.

GARANTIA | GARANTIZAR

Os artigos da marca MOTAKO apresentam garantia de 2 anos após venda, salvo informação contraditória presente no catálogo.

Todos os produtos que apresentem algum defeito ou anomalia de fabrico até 15 dias, estes serão substituídos de imediato por novos. Após este prazo, os produtos com anomalia aparente deverão ser enviados para análise dos nossos serviços técnicos.

Caso seja detetado algum defeito de fabrico ou avaria provocada pelo mesmo, o artigo deverá ser reparado ou, caso a reparação não seja possível, deverá ser feita a troca por um produto novo. Em alternativa, poderá ser feito um crédito do valor, caso o cliente assim o pretenda. Esta análise não deverá exceder os 30 dias.

Todas as devoluções deverão ser acompanhadas por um documento de devolução com identificação do motivo da devolução e o número e data do documento de compra.

Em toda a situação de avaria ou troca de produtos, qualquer que seja a sua natureza, a MOTAKO, em representação dos seus fabricantes, não reconhece qualquer fatura de reparação de terceiros, a menos que acordado por escrito.

Sólo se aceptan devoluciones de artículos de nuestro catálogo MOTAKO transcurridos 15 días desde la fecha de la factura, por motivos de no satisfacción con el producto, debiendo presentarse en su caja original y con cuidado. Las devoluciones deben solicitarse previamente a nuestra empresa y, en caso de aprobación, deben enviarse a nuestro almacén con el documento correspondiente y referencia a la factura de compra.

Los productos de la marca MOTAKO tienen una garantía de 2 años después de la venta, a menos que se indique lo contrario en el catálogo.

Todos los productos que presenten un defecto de fabricación o anomalía en el plazo de 15 días serán sustituidos inmediatamente por otros nuevos.

Pasado este plazo, los productos con anomalías aparentes deberán ser enviados para su análisis por nuestros servicios técnicos. Si se detecta algún defecto de fabricación o avería provocada por el mismo, se deberá reparar el artículo o, si la reparación no es posible, se deberá realizar el cambio por un nuevo producto. Alternativamente, se puede realizar un abono del importe, si el cliente así lo desea. Este análisis no debe exceder los 30 días.

Todas las devoluciones deben ir acompañadas de un documento de devolución que identifique el motivo de la devolución y el número y fecha del documento de compra.

En cualquier situación de avería o cambio de productos, cualquiera que sea su naturaleza, MOTAKO, por cuenta de sus fabricantes, no reconoce ninguna factura de reparación de terceros, salvo acuerdo por escrito.

LITÍGIO | LITIGIO

Em caso de litígio o foro competente será o da Comarca de Mafra, com exclusão de qualquer outro.

En caso de litigio, el foro competente será el del Distrito de Mafra, con exclusión de cualquier otro.

MOTAKO



É proibida a reprodução total ou parcial dos elementos gráficos deste catálogo sem autorização prévia da Elta - Iluminação, Lda. As cores apresentadas podem sofrer alterações face à realidade dos produtos devido ao processo de impressão. Todos os dados presentes nesta publicação estão corretos salvo erro tipográfico.

A Elta - Iluminação, Lda. reserva-se no direito de alterar especificações técnicas, bem como atualizar as características dos produtos nas suas fichas técnicas, devido à evolução constante dos nossos produtos.

Prohibida la reproducción total o parcial de los elementos gráficos de este catálogo sin autorización previa de Elta - Iluminación, Lda. Los Colores mostrados pueden cambiar debido a la realidad de los productos debido al proceso de impresión. Todos los datos de esta publicación son correctos salvo error tipográfico.

Elta - Iluminación, Lda. se reserva el derecho de modificar las especificaciones técnicas, así como actualizar las características de los productos en sus fichas técnicas, debido a la constante evolución de nuestros productos.

FICHA TÉCNICA

Design e Editorial
Departamento Marketing Motako

Produção Fevereiro 2026
Producción Febrero 2026

Versão / Versión
2026

comercial@motako.pt
Tel.: +351 261 027 304
(Chamada para rede fixa nacional)

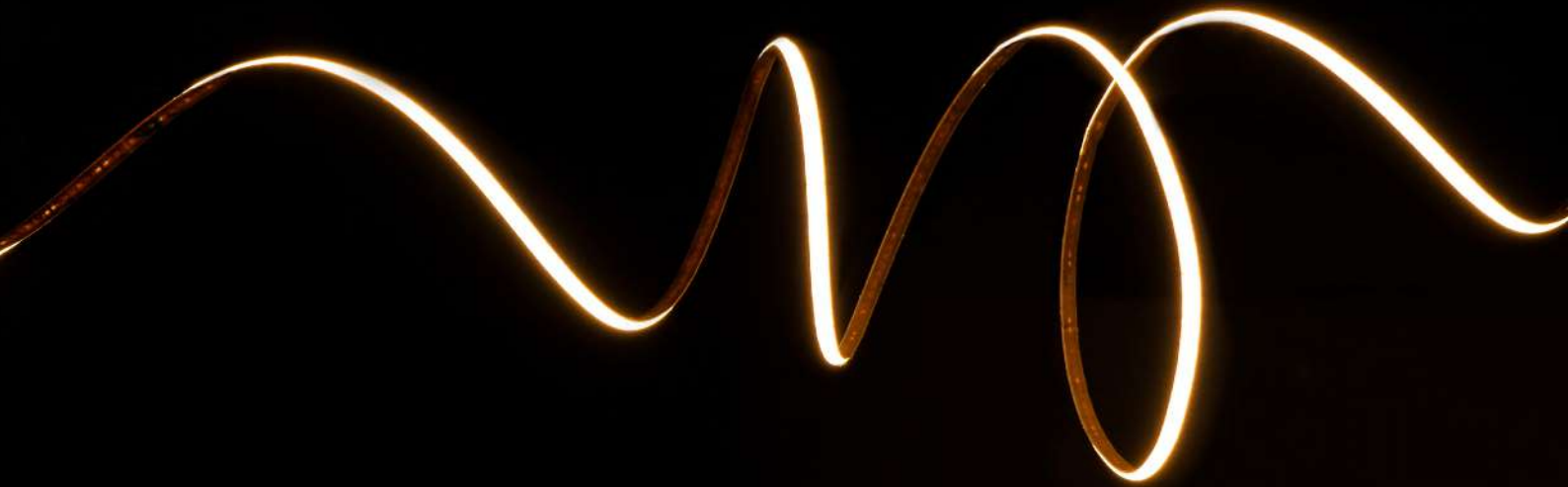

**EVERYTHING
IS CONNECTED**

WWW.MOTAKO.PT



MOTAKO[®]
LED LIGHTING SOLUTIONS



LED LIGHTING SOLUTIONS

WWW.MOTAKO.PT

IMAGEM CAPA: SERVIÇO HIL