



PLIOGRIP

Identification system

XI/23 - 0960 0003 0010 E



Operating
instruction
in video

SES-STERLING [®]
www.ses-sterling.com





IDENTIFICATION SYSTEM PLIOGRIP

SES-STERLING[®]
www.ses-sterling.com

Applied by clipping direct to wires and cables

Application



Wire and cable identification before or after connection. Small footprint allows for confined space fitment.

3 sizes of markers

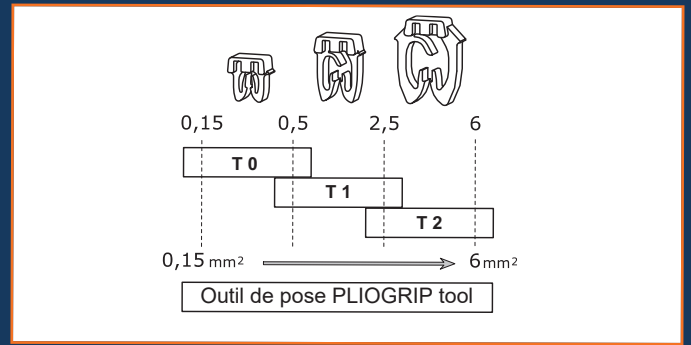

3 sizes of markers for sections from 0,15 to 6 mm².

Large range of use

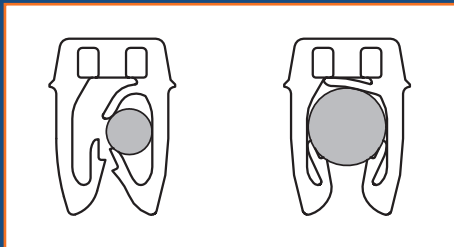

Retained by claw

Retained by blocking

Assembly direction

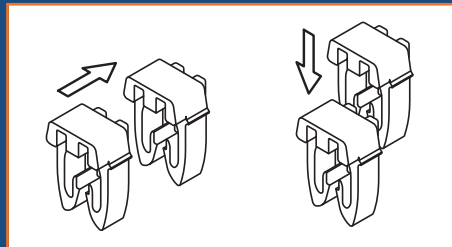

Axial

Radial

Same size of characters

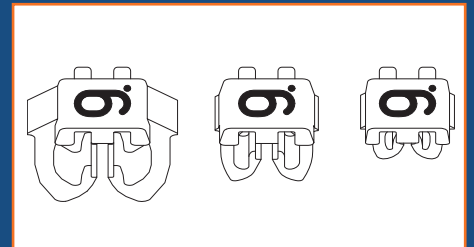

Identical character size, regardless of the size of the markers

PLIOGRIP TOOL

One tool for the rapid use of three types of markers.
Easy loading of the markers.
Easy application to already connected cables.

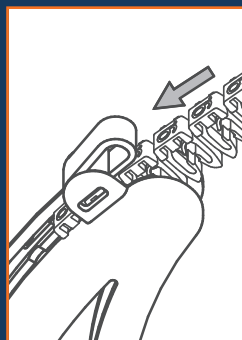

Ease of assembly

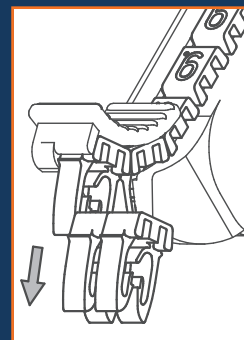

Radial assembly

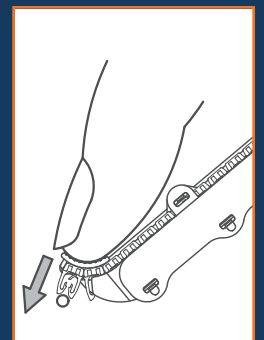

Ergonomy

SALES PROGRAMME



PLIOGRIP marker carriers

| | |
|--------------------------------|--------------|
| Material: | POM |
| Operating temperatures: | -40 to +90°C |

Example for order :
 group

| detail article | code colour | code marker |
|----------------|-------------|-------------|
| 037600x | x | x |
| x | x | x |
| x | x | x |
| x | x | x |

| | | |
|----|---|----------------|
| T0 | F | 03760010001F |
| T1 | ⊥ | 03760011004TER |
| T2 | 3 | 037600220053 |

| detail article | article number | type | white / yellow* | colours | mm | section mm ² | numerical markers | alphabetical markers symbols and unprinted |
|----------------|----------------|------|------------------|------------------|-----------|-------------------------|-------------------|--|
| | | T0 | 0376 0010 *** ** | 0376 0020 *** ** | 0,8 - 2,2 | 0,15 - 0,5 | 1000 | 300 |
| | | T1 | 0376 0011 *** ** | 0376 0021 *** ** | 2,2 - 3,8 | 0,5 - 2,5 | 1000 | 300 |
| | | T2 | 0376 0012 *** ** | 0376 0022 *** ** | 3,8 - 5,3 | 2,5 - 6 | 800 | 200 |

* Markers L1 L2 L3, PE are not available for models T1 and T2.

| code colour | 010 | 006 | 007 | 005 | 004 | 003 | 002 | 008 | 013 | 001 |
|-------------|-------|-------|-----|--------|--------|-------|------|--------|------|-------|
| | black | brown | red | orange | yellow | green | blue | violet | grey | white |

| code markers | A | B | C | D | E | F | G | H | I | J | K | L | M | N | O | P | Q | R | S | T | U | V | W | X | Y | Z | / | . | + | - | ~ | ⊥ | ⊕ | ⊖ | 0 | 1 | 2 | 3 | 4 | 5 | 6 | 7 | 8 | 9 | + | - |
|--------------|-------------|-------------|-------------|-------------|-------------|-------------|-------------|-------------|-------------|-------------|-------------|-------------|-------------|-------------|-------------|-------------|-------------|-------------|-------------|-------------|-------------|-------------|-------------|-------------|-------------|-------------|-------------|-------------|-------------|-------------|-------------|-------------|-------------|-------------|-------------|-------------|-------------|-------------|-------------|-------------|-------------|-------------|-------------|-------------|-------------|-------------|
| | 0376 **** A | 0376 **** B | 0376 **** C | 0376 **** D | 0376 **** E | 0376 **** F | 0376 **** G | 0376 **** H | 0376 **** I | 0376 **** J | 0376 **** K | 0376 **** L | 0376 **** M | 0376 **** N | 0376 **** O | 0376 **** P | 0376 **** Q | 0376 **** R | 0376 **** S | 0376 **** T | 0376 **** U | 0376 **** V | 0376 **** W | 0376 **** X | 0376 **** Y | 0376 **** Z | 0376 **** / | 0376 **** . | 0376 **** + | 0376 **** - | 0376 **** ~ | 0376 **** ⊥ | 0376 **** ⊕ | 0376 **** ⊖ | 0376 **** 0 | 0376 **** 1 | 0376 **** 2 | 0376 **** 3 | 0376 **** 4 | 0376 **** 5 | 0376 **** 6 | 0376 **** 7 | 0376 **** 8 | 0376 **** 9 | 0376 **** + | 0376 **** - |

Box available with a European suspension hole.

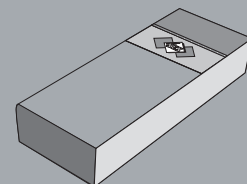

PLIOGRIP TOOL

| type | article number | |
|---------------|----------------|----|
| PLIOGRIP-TOOL | 0376 0100 000 | 10 |



PLIOGRIP TOOL assortment box

| type | article number | |
|-------------------|----------------|---|
| KIT 1 PLIOGRIP T1 | 0376 8001 000 | 1 |
| KIT 2 PLIOGRIP T2 | 0376 8002 000 | 1 |
| KIT 3 PLIOGRIP T0 | 0376 8003 000 | 1 |





SES-STERLING [®]
www.ses-sterling.com

All around the cable

WORKING WITH SES-STERLING

We at SES-STERLING take pride in the fact that since our family enterprise was created in 1928, we have managed to grow it into an internationally renowned cable accessories manufacturer that can guarantee fast worldwide delivery to its clients. We're considered as a forerunner in the transformation of raw materials into electrical wiring accessories mainly thanks to the fact that we manage and control the whole production process from A to Z. We can therefore guarantee you top quality and innovative products that are 100% "Made in France".

A strong research culture makes sure the cable protection, marking and fixing products manufactured by SES-STERLING are manufactured to fulfil the needs of all our customers. With more than 26000 product references our catalogue will be able to provide trusted products of any type our clients are seeking offering the best balance between price and quality, without having to compromise on creativity. What you really need is a continuous availability, fast delivery, sufficient stocks and efficient distribution. Thanks to these elements we are able to offer first-class responsiveness, troubleshooting and support for our partners.

Our specialised team of research and development engineers work all year round to be sure that the most effective raw material mixes are used in our products so that the end user will sleep soundly whenever completing a project. All products are constantly adapted for ease of use in the field.

The SES STERLING commercial and technical teams aim to be as close as possible to our all important clients with offices in Switzerland, Belgium, Germany and the United Kingdom. And thanks to our extensive partner network in 50 countries around the world we can offer our quality products to you in the time scale required. Our teams are always ready to listen to your feedback, suggestions and questions. Local contact is the key factor, not only can we respond to your needs, but we aim to fulfil them whenever they arise.

